

elco

2016 INDUSTRY CATALOGUE



elco

2016 INDUSTRY CATALOGUE



THE COMPANY	p. 4
RANGE OVERVIEW	p. 16
EK EVO RANGE	p. 26
NEXTRON RANGE	p. 76
N10 RANGE	p. 138
HO-TRON RANGE	p. 158
GHO-TRON RANGE	p. 178
DUOBLOCK RANGE	p. 190
GAS TRAINS	p. 198
CONTROL UNITS	p. 204
OPTIONS	p. 206



CUTTING-EDGE BURNERS FOR HEATING AND INDUSTRIAL APPLICATIONS

Innovative soul

Being a specialist in burners conception and manufacturing, ELCO is nowadays one of the leaders in the combustion technology. By linking a strong innovative ability to a developing will, ELCO conceives performing and reliable burners that respect the environment as well as corresponding services, in order to establish a lasting relationship with its customers.

The mission

ELCO always looks for the best technologies and develops new ones to improve the efficiency of its solutions. Our R&D Laboratories are committed to develop innovative technological solutions allowing to:

- optimize the running of the installations lowering the use of primary energy;
- ease professional's work improving human machine interface and maintenance;
- preserve the environment lowering acoustic and exhaust gas emissions.

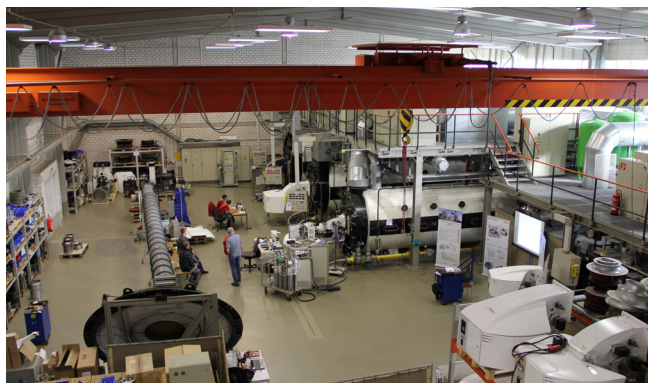

Product range

Our experience at combustion disposal
in a complete range of burners from 11 kW to 80 MW:



VECTRON
11 - 2300 kW
Gas, light oil and
dual fuel



PROTRON
15 - 550 kW
Gas and light oil



NEXTRON
250 - 11200 kW
Gas, light oil and
dual fuel



EK EVO
250 - 13500 kW
Gas and dual fuel

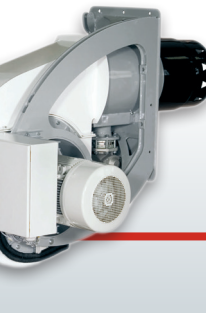

N10
1300 - 16000 kW
Gas, light oil and
dual fuel





Professional staff

Taking advantage of a staff composed of technicians and engineers with a long experience, ELCO is able to provide professional support to the customer in order to define together the best solution and to develop and manage the project through its entire life-cycle.

ELCO Service activities define the standards in the market and each customer can rely on high performance and reliable products.



HO/GHO-TRON

68 - 17000 kW
Heavy oil and
dual fuel



D-TRON
230 - 34000 kW
Gas, light oil, heavy oil
and dual fuel

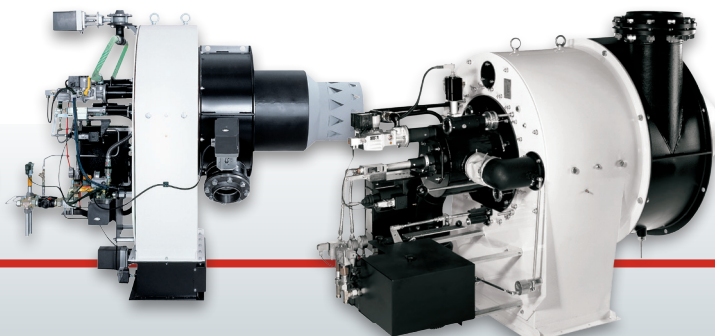

EK-DUO
600 - 16000 kW
Gas, light oil and
dual fuel



RPD
500 - 80000 kW
Gas, light oil, heavy oil
and dual fuel



Worldwide network

Capitalising more than 80 years of working experience, ELCO has been capable to build loyal partnerships and today can count on reliable Partners all over the World.

Combining an instinctively global perspective with a genuinely multicultural approach, ELCO today offers skilled and experienced experts available in more than 70 Countries.

In Europe

3 production plants

6 commercial branches

Strong commercial presence through a network of reliable dealers and partners

Worldwide

2 Sales Offices in Russia and China

Distribution in over 70 Countries

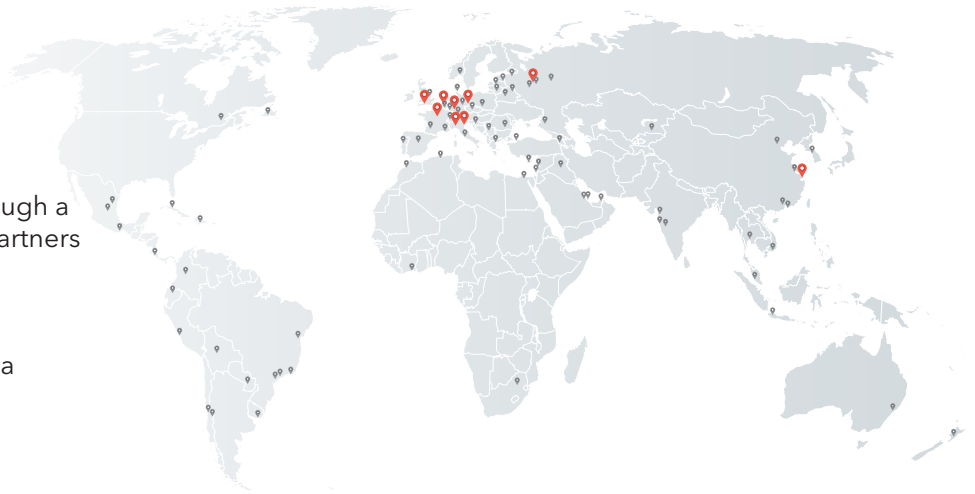

ELCO is developing a worldwide network of valuable Service Partners, consisting of well-trained local engineers, to carry out its service operations.



Time to market

To promptly deal with the requests of an ever changing market, ELCO has adopted a finished products and spare parts warehouse of over 8000 square meters.

Quick response to customer requests and consistent warehouse availability allow to reduce the delivery time and give a better support to the end user.

Reliable supply of spare parts

Spare parts have always had a great importance inside the ELCO world. Considering the high amount of parts involved in every single product, some of these parts might naturally need to be substituted ELCO can count on a International network ELCO offering original spare parts in order to guarantee the highest quality, reliability and safe continued operation of the appliance.

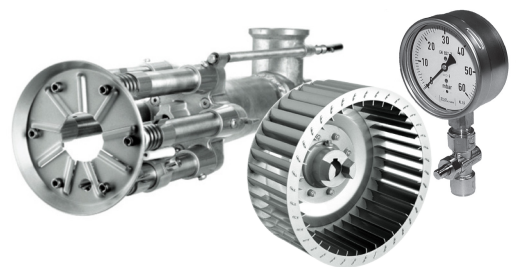



Solutions for every need

A long presence in the international market has allowed ELCO to build a strong experience in burner customization and to develop products that are able to guarantee reliability, quality and high performance even in the most extreme working conditions.



Competent advice

Your contacts at ELCO and its partners are recognized experts with years of experience.

Our worldwide support starts from concept creation to planning, design and project management up to commissioning and on-going operation of the plant throughout its life cycle.

As an ELCO customer, you can rely on your installation to perform reliably. Our guarantee is backed up by a service that sets standards in our field.

References

ELCO has been chosen as the ideal partner from worldwide companies to design installations where technical specifications and environmental conditions require a specific design.

In the next pages you will find a selection of our international references.



Worldwide references

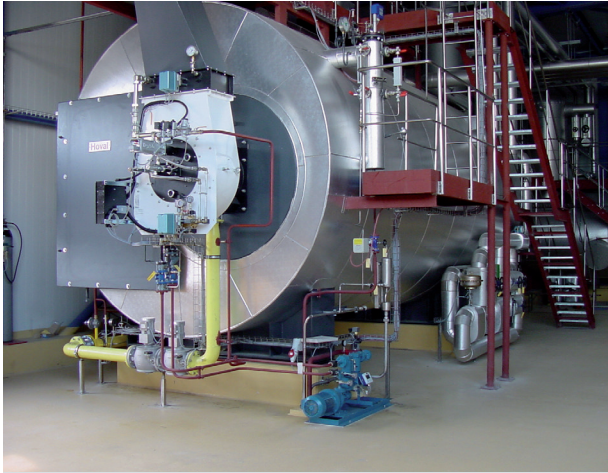

Stuttgart, Germany

Burner type:
1x EK-DUO 2.550 GL-EUF
2x EK-DUO 2.700 GL-EUF



Hamburg, Germany

Burner type:
2x N7.4500 GL-E



Beijing, China

Burner type:
2x N7.4500 G-R
2x N7.3600 G-R



Khanty-Mansiysk, Russia

Burner type:
4x N10.12000 G-E



Stavanger, Norway

Burner type:
2x EK-DUO 3.1600 G-E



Beijing, China

Burner type:
1x EK EVO 8.5800 G-EU3
2x EK EVO 8.7100 G-EU3



Hohhot, Inner Mongolia, China

Burner type:
2x EK EVO 6.2900 G-E



Amsterdam, Netherlands

Burner type:
2x RPD 60 GL-EU



Fredrikstad, Norway

Burner type:
1x N9.10400 G-EU3



Beijing, China

Burner type:
4x RPD 100 G-EU

Technologies and Systems

To constantly improve its products, ELCO is committed to develop innovative technological solutions allowing to optimize the running of the installations, to ease professional's work, and naturally to preserve the environment. In order to provide quick responses to its market's exigencies, the range of ELCO burners is entirely conceived around a consistent combination of Systems.



MDE2 System

Permanent communication of information easy to use

Equipped with the MDE2 System, the universal language Elcogram and the 5-button keyboard, ELCO burners adjust themselves and constantly communicate to professional operators:

- real time information about each ignition and during the running;
- statistical information about burner operation recorded during the whole year before the maintenance operations.

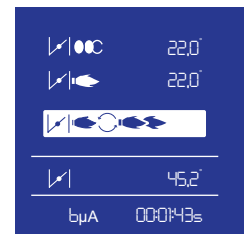
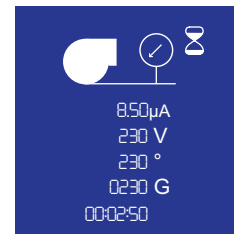
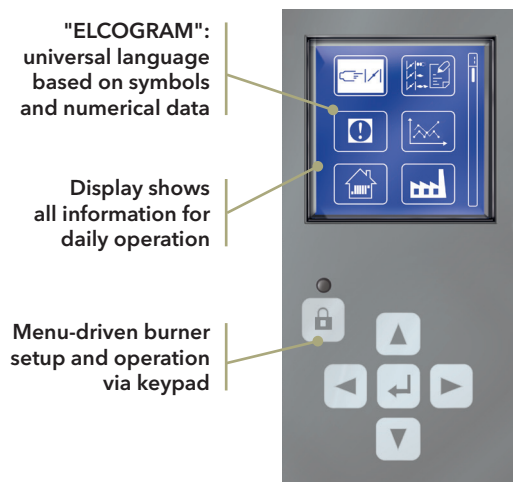

Elcogram, a universal language

As ELCO products are distributed worldwide, the company has developed a universal language composed of pictograms and numerical data. The pictograms use the majority of the symbols used on the wiring diagrams which are recognised and understood by all Nations. This ensures that information is easier to read than ever before.



GEM System

Electronic burner control: high safety and low costs

The use of electronic technologies in burner control systems helps to reduce running costs, improve reliability of operation and lower pollutant emissions. The electronic combustion manager used on ELCO burners are responsible not only for burner control (formerly the task of the traditional automatic combustion control unit) but also for fuel/air regulation. Data stored electronically has replaced the mechanical characteristic curve and help to achieve an unprecedented level of precision in air/fuel ratio regulation across the burner's entire control range, a prerequisite for efficient, energy- and cost-saving operation.

The GEM System controls the position of one or more activators simultaneously.

The servomotors of the air flow and oil components are controlled by a microprocessor which contains set points defined for each load curve. An additional advantage of the GEM is that it provides specific information on all the commands and states of the overall system: these can be accessed directly or by remote control.

The digital programming is user-friendly, it is carried out through the display of the MDE2 System or through a PC by using a simple procedure facilitated by easy instructions in a clear language.



AGP System

An outstanding technology for gas burners

Developed and produced by ELCO, the AGP System (proportional air-gas) provides:

- perfect stability of the air-gas mixture;
 - a constantly high CO₂ content over the whole burner power range;
 - precise control of air excess, which is important for high-efficiency operation, in particular for condensing generators.
- The AGP measures: the gas pressure downstream of the gas train, the air pressure behind the flame holder, the furnace backpressure.

Any variations in the three pressures are immediately and simultaneously recorded by the system which automatically restores the correct gas/combustion air ratio.

AGP maintains a constant gas/combustion air ratio even in the presence of:

- positive or negative variations in the gas pressure;
- variations in air flow due to changes in the electrical supply voltage or fouling of the ventilation system;
- variations in the furnace and flue draft pressure on start-up and during load changes.



Variatron

Speed regulation: noise reduction and energy saving

To improve the performance of heating or industrial systems, ELCO applies Variatron (fan speed control). Conventionally, the air in modulating burners is regulated by an air flap. In the partial load range, a large amount of the air pressure generated by the ventilator goes to waste.

With speed regulation, the speed of the combustion-air fan is varied continuously depending on the burner output required. Full speed is reached only at maximum burner output. In the predominant partial load range, the lower speed translates into significant reductions in power consumption and noise emissions. The Variatron operates in phase with the air damper both with the GEM System and with the AGP System, which guarantees a combustion with minimum air excess by continuously monitoring all operating conditions.

Application of the Variatron to ELCO burners results in:

- electrical consumption savings of the order of 50%;
- turndown ratio of up to 1:10, resulting in perfect adaptation to system requirements and improvement in average seasonal efficiency, in particular with condensing or low-temperature boilers or specific processes;
- silent start-up and average overall noise reduction between 2 dB(A) (at maximum power) and 12 dB(A) (at minimum power).



Low Noise System

Increase the comfort in-use and protect the environment

Among all the harmful things that men have to bear with every day, the most annoying is noise, which is difficult to reduce and expensive to get rid of.

This is the reason why ELCO has developed quiet burners both by selecting sound absorbent materials, and by treating each noise sources internally. The main noise comes from the air intake and the air mixing in the fan wheel: all the ELCO burners are equipped with a sound trap on the air intake channel leading to the fan.

This brings the acoustic level to a compatible value in respect of the environment.

Technologies and Systems

ELCO R&D Laboratories have capitalised more than 80 years of experience in the field of standard burners (with normal emission) in order to develop a parallel range of low emissions burners. In addition to scrupulously respecting the limits prescribed by European directives regulating pollutant emission, the goal of ELCO is to guarantee values largely below those established by regulations.

In order to reach these results the low NO_x burner range takes advantage of innovative combustion technologies.



Diamond Head

Low emissions and reliable operation

The principle of the Diamond Head gas combustion is based on the internal recirculation of the combustion flue gases. These are partially drawn into the base of the flame via triangular openings positioned at the end of the combustion head.

The position and geometry of the gas injectors are such that a significant quantity of combustion flue gas is drawn in and rapidly mixed with air and gas at the root of the flame. This mixture crosses the main reaction area, slowing the combustion, which resulted in lowering the main flame temperature.

The result of this staging combustion is a significant reduction in the formation of thermal nitrogen oxides.

The advantage of this internal recirculation technique is an automatic adjustment to the quantity of recycled combustion flue gases: the volume of the flame is always as low as possible, which has a very minor effect on the nominal power of the generator, unlike external recirculation systems.

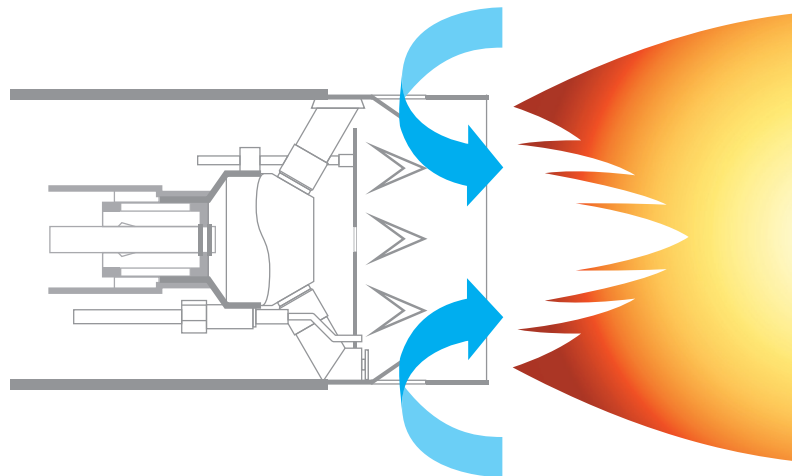

Free Flame

The pinnacle of low-polluting burner engineering

The principle of the Free Flame combustion is based on rapid gasification of the fuel by recirculating the combustion gases internally and allows the fuel-air to mix quickly. Once the fuel has been vaporized, it will burn and stabilize 30 centimetres from the combustion head.

The flame appears to "float freely" hence the name "Free Flame". The heat absorbed by the gasification oil will cause a significant drop in the flame's temperature and a decrease in the formation of the thermal nitrogen oxide.

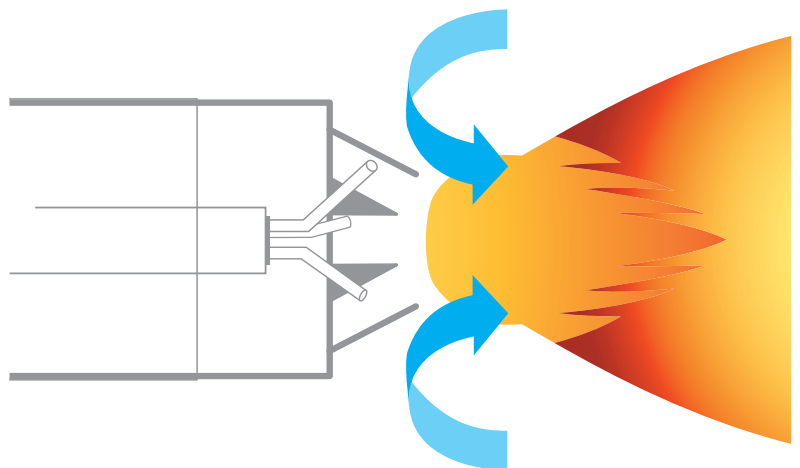

Technical assistance



Commissioning

For safe and efficient operation of your burner system it is very important that the burner is commissioned by an expert. The combustion will be optimally adjusted over the whole power range of the burner, and all the safeties will be tested. Of course you will receive a report. ELCO's service technicians are able, like no other, in performing this job adequate and competent, to run your installation worry-free.

Maintenance and inspection

The burner is a crucial part of the installation. To keep your installation in good conditions, it is important to maintain the burner periodically. It is also very important to inspect all the safeties to ensure that your system operates safely. Fortunately, you can rely on the professional services of ELCO which can perfectly perform this service for you.

The Burner Academy

In order to respond to the needs of our customers we created the Burner Academy, a real school where the know-how of our technicians is diffused to our partners.

We provide the opportunity for boiler room personnel, operators and engineers to attend a series of training sessions carried out on our test bench by highly qualified instructors, who held the courses in English, German, French, Italian and Dutch language.

The Burner Academy uses various training locations where boilers are installed and where people can be trained in theory and in practice. We offer courses at different levels and also the possibility to handle all your needs in a customer-specific training.



Worldwide Service Network

In Western Europe, ELCO has a well organized service network.

Outside Western Europe ELCO uses a network of partners, consisting of well-trained local engineers, to carry out its service operations. These technicians are able to perform both commissioning and local service and they do it in a very professional way.

EK EVO and NEXTRON

Burner body

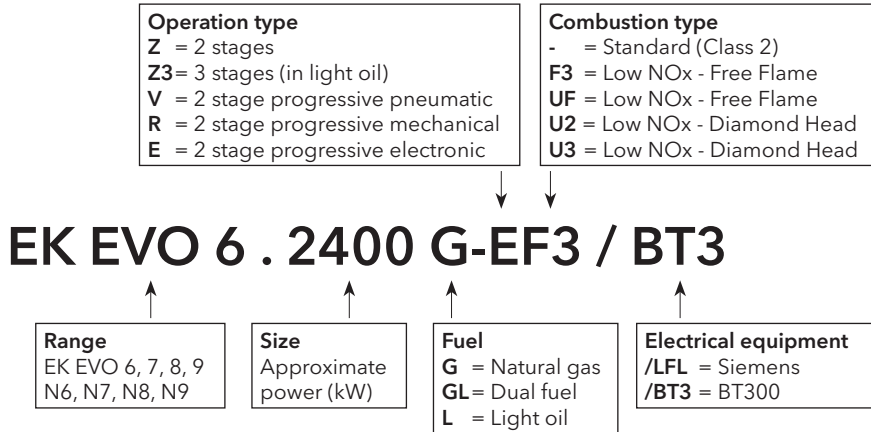

Combustion head

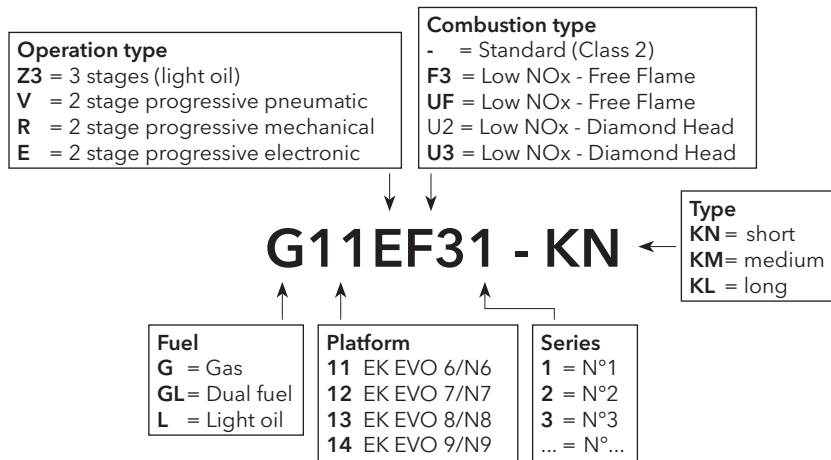

Gas train

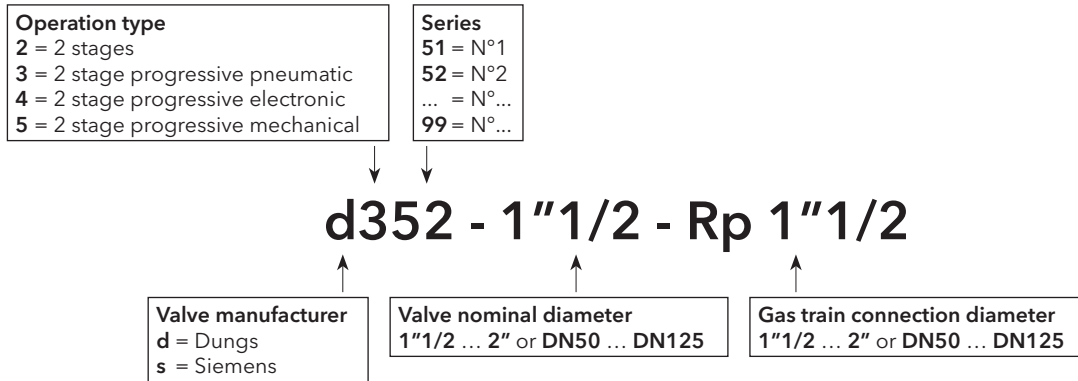

N10

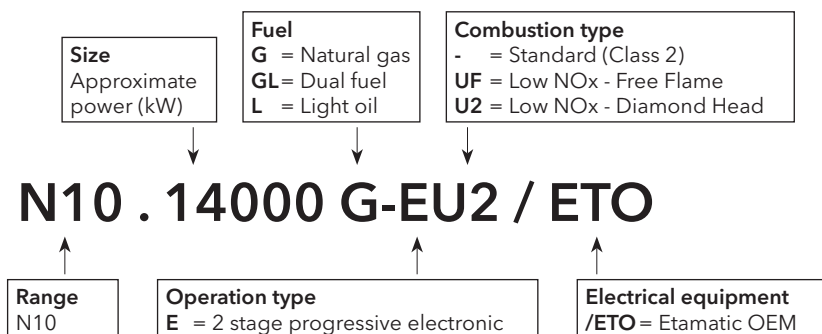

HO-TRON and GHO-TRON

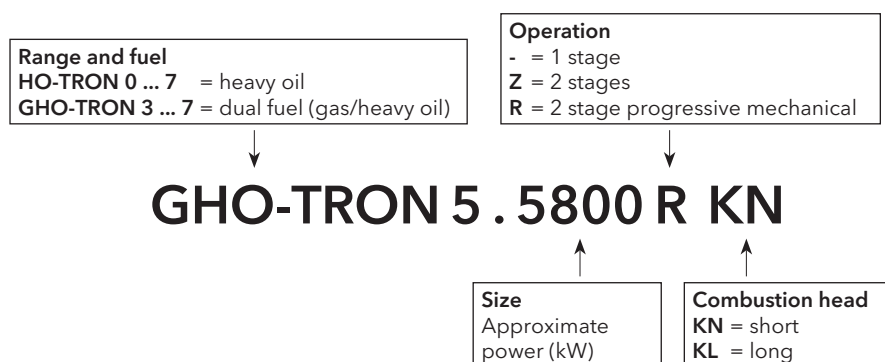

D...-TRON

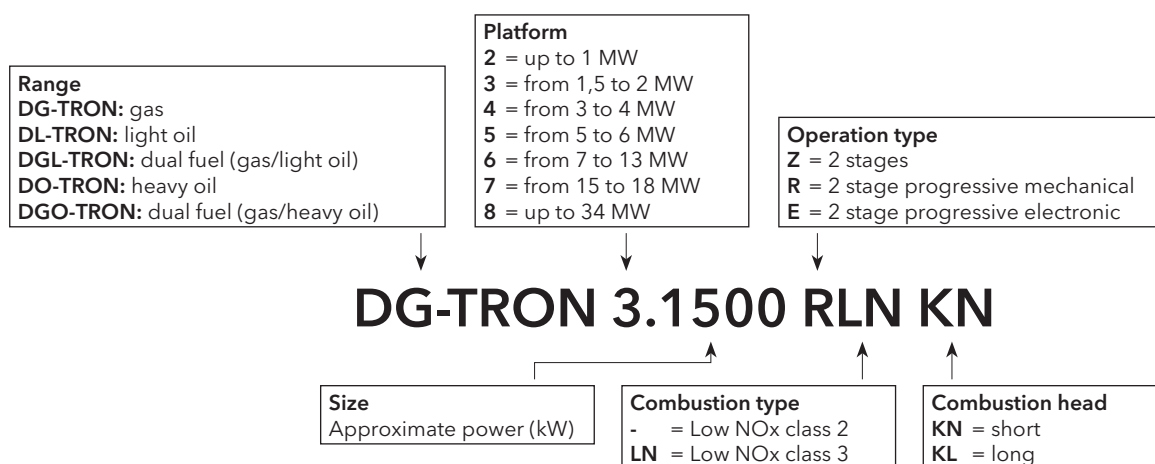

EK-DUO and RPD

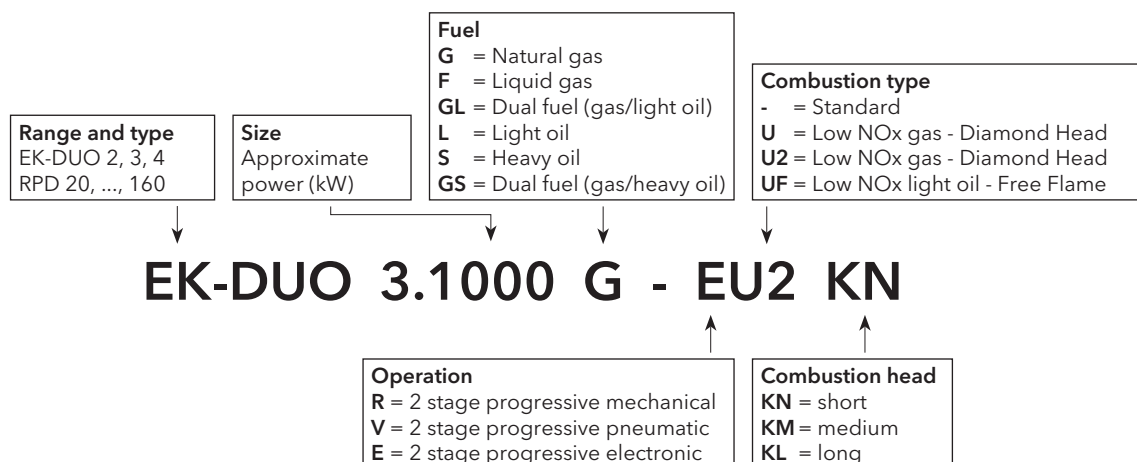

EK EVO | GAS RANGE

TWO STAGE PROGRESSIVE/MODULATING ELECTRONIC

EK EVO 6.2400 G-E	390 ... 2650 kW		p. 28
EK EVO 6.2900 G-E	400 ... 3200 kW		p. 28
EK EVO 7.3600 G-E	580 ... 4300 kW		p. 28
EK EVO 7.4500 G-E	680 ... 5400 kW		p. 28
EK EVO 8.5800 G-E	620 ... 6570 kW		p. 32
EK EVO 8.7100 G-E	610 ... 8150 kW		p. 32
EK EVO 9.8700 G-E	780 ... 9700 kW		p. 32
EK EVO 9.10400 G-E	850 ... 11230 kW		p. 32

0 2000 4000 6000 8000 10000 12000 kW

TWO STAGE PROGRESSIVE/MODULATING ELECTRONIC Low NOx

EK EVO 6.2400 G-EF3	340 ... 2500 kW		p. 36
EK EVO 6.2900 G-EF3	340 ... 2900 kW		p. 36
EK EVO 7.3600 G-EF3	470 ... 3980 kW		p. 36
EK EVO 7.4500 G-EF3	510 ... 4290 kW		p. 36
EK EVO 7.5800 G-EU2	600 ... 5850 kW		p. 40
EK EVO 8.5800 G-EU3	600 ... 6070 kW		p. 44
EK EVO 8.7100 G-EU3	700 ... 7700 kW		p. 44
EK EVO 9.8700 G-EU3	850 ... 8530 kW		p. 44
EK EVO 9.10400 G-EU3	910 ... 10500 kW		p. 44
EK EVO 9.13000 G-EU2	2500 ... 13500 kW		p. 48

0 3000 6000 9000 12000 15000 kW

EK EVO | DUAL FUEL RANGE (GAS/LIGHT OIL)

TWO STAGE PROGRESSIVE/MODULATING ELECTRONIC IN GAS / THREE STAGES IN LIGHT OIL

EK EVO 6.2400 GL-EZ3	290 ... 2550 kW		p. 52
EK EVO 6.2900 GL-EZ3	290 ... 3050 kW		p. 52
EK EVO 7.3600 GL-EZ3	300 ... 3600 kW		p. 52
EK EVO 7.4500 GL-EZ3	510 ... 4740 kW		p. 52

TWO STAGE PROGRESSIVE/MODULATING ELECTRONIC IN GAS AND IN LIGHT OIL

EK EVO 6.2400 GL-E	250 ... 2230 kW		p. 56
EK EVO 6.2900 GL-E	320 ... 2970 kW		p. 56
EK EVO 7.3600 GL-E	490 ... 3650 kW		p. 56
EK EVO 7.4500 GL-E	510 ... 4740 kW		p. 56
EK EVO 8.5800 GL-E	790 ... 6000 kW		p. 60
EK EVO 8.7100 GL-E	790 ... 7700 kW		p. 60
EK EVO 9.8700 GL-E	880 ... 8530 kW		p. 60
EK EVO 9.10400 GL-E	910 ... 10620 kW		p. 60

TWO STAGE PROGRESSIVE/MODULATING ELECTRONIC IN GAS AND IN LIGHT OIL Low NOx

EK EVO 6.2400 GL-EF3	280 ... 1920 kW		p. 64
EK EVO 6.2900 GL-EF3	340 ... 2890 kW		p. 64
EK EVO 7.3600 GL-EF3	470 ... 3980 kW		p. 64
EK EVO 7.4500 GL-EF3	510 ... 4500 kW		p. 64
EK EVO 8.5700 GL-EF3	830 ... 6450 kW		p. 68
EK EVO 9.6500 GL-EF3	860 ... 6950 kW		p. 68
EK EVO 9.8700 GL-EUF	1040 ... 8500 kW		p. 68
EK EVO 9.10400 GL-EUF	1160 ... 9570 kW		p. 68

EK EVO | OPTIONS

BURNER VARIANTS p. 72

BURNER KITS p. 74

SPECIAL CONFIGURATIONS p. 75

NEXTRON | GAS RANGE

TWO STAGE PROGRESSIVE/MODULATING MECHANICAL

N6.2400 G-R	390 ... 2500 kW		p. 78
N6.2900 G-R	400 ... 3000 kW		p. 78
N7.3600 G-R	580 ... 4100 kW		p. 78
N7.4500 G-R	680 ... 5000 kW		p. 78

TWO STAGE PROGRESSIVE/MODULATING PNEUMATIC

N6.2400 G-V	390 ... 2500 kW		p. 82
N6.2900 G-V	400 ... 3000 kW		p. 82
N7.3600 G-V	580 ... 4100 kW		p. 82
N7.4500 G-V	680 ... 5000 kW		p. 82

TWO STAGE PROGRESSIVE/MODULATING PNEUMATIC Low NOx

N6.2400 G-VF3	340 ... 2300 kW		p. 86
N6.2900 G-VF3	360 ... 2850 kW		p. 86
N7.3600 G-VF3	500 ... 3900 kW		p. 86
N7.4500 G-VF3	600 ... 4200 kW		p. 86

TWO STAGE PROGRESSIVE/MODULATING ELECTRONIC

N6.2400 G-E	390 ... 2500 kW		p. 90
N6.2900 G-E	400 ... 3000 kW		p. 90
N7.3600 G-E	580 ... 4100 kW		p. 90
N7.4500 G-E	680 ... 5000 kW		p. 90
N8.5800 G-E	740 ... 6570 kW		p. 94
N8.7100 G-E	800 ... 7800 kW		p. 94
N9.8700 G-E	880 ... 9200 kW		p. 94
N9.10400 G-E	960 ... 11200 kW		p. 94

TWO STAGE PROGRESSIVE/MODULATING ELECTRONIC Low NOx

N6.2400 G-EF3	340 ... 2300 kW		p. 98
N6.2900 G-EF3	360 ... 2850 kW		p. 98
N7.3600 G-EF3	500 ... 3900 kW		p. 98
N7.4500 G-EF3	600 ... 4200 kW		p. 98
N8.5800 G-EU3	640 ... 5800 kW		p. 102
N8.7100 G-EU3	700 ... 7100 kW		p. 102
N9.8700 G-EU3	850 ... 8530 kW		p. 102
N9.10400 G-EU3	900 ... 10200 kW		p. 102

NEXTRON | DUAL FUEL RANGE (GAS/LIGHT OIL)

TWO STAGE PROGRESSIVE/MODULATING MECHANICAL IN GAS / THREE STAGES IN LIGHT OIL

N6.2400 GL-RZ3	290 ... 2550 kW		p. 106
N6.2900 GL-RZ3	290 ... 2950 kW		p. 106
N7.3600 GL-RZ3	300 ... 3600 kW		p. 106
N7.4500 GL-RZ3	410 ... 4350 kW		p. 106

TWO STAGE PROGRESSIVE/MODULATING ELECTRONIC IN GAS AND IN LIGHT OIL

N6.2400 GL-E	250 ... 2230 kW		p. 110
N6.2900 GL-E	320 ... 2970 kW		p. 110
N7.3600 GL-E	490 ... 3650 kW		p. 110
N7.4500 GL-E	510 ... 4750 kW		p. 110
N8.5800 GL-E	800 ... 5350 kW		p. 114
N8.7100 GL-E	820 ... 7340 kW		p. 114
N9.8700 GL-E	880 ... 8530 kW		p. 114
N9.10400 GL-E	910 ... 10620 kW		p. 114

TWO STAGE PROGRESSIVE/MODULATING ELECTRONIC IN GAS AND IN LIGHT OIL Low NOx

N6.2400 GL-EF3	280 ... 1920 kW		p. 118
N6.2900 GL-EF3	340 ... 2890 kW		p. 118
N7.3600 GL-EF3	470 ... 3980 kW		p. 118
N7.4500 GL-EF3	510 ... 4500 kW		p. 118
N8.5700 GL-EF3	830 ... 6450 kW		p. 122
N9.6500 GL-EF3	830 ... 6950 kW		p. 122
N9.8700 GL-EUF	1040 ... 8500 kW		p. 122
N9.10400 GL-EUF	1160 ... 9570 kW		p. 122

NEXTRON | LIGHT OIL RANGE

TWO STAGE PROGRESSIVE/MODULATING ELECTRONIC

N6.2400 L-E	510 ... 2030 kW		p. 126
N6.2900 L-E	650 ... 3100 kW		p. 126
N7.3600 L-E	900 ... 3850 kW		p. 126
N7.4500 L-E	1300 ... 4900 kW		p. 126
N8.5800 L-E	1350 ... 5350 kW		p. 128
N8.7100 L-E	1470 ... 7340 kW		p. 128
N9.8700 L-E	2400 ... 8530 kW		p. 128
N9.10400 L-E	2820 ... 10620 kW		p. 128

TWO STAGE PROGRESSIVE/MODULATING ELECTRONIC Low NOx

N6.2400 L-EF3	360 ... 1850 kW		p. 130
N6.2900 L-EF3	480 ... 2950 kW		p. 130
N7.3600 L-EF3	680 ... 4070 kW		p. 130
N7.4500 L-EF3	740 ... 4820 kW		p. 130
N8.5700 L-EF3	1100 ... 6450 kW		p. 132
N9.6500 L-EF3	1200 ... 6600 kW		p. 132
N9.8700 L-EUF	1800 ... 8500 kW		p. 132
N9.10400 L-EUF	2550 ... 9570 kW		p. 132

NEXTRON | OPTIONS

BURNER VARIANTS _____ p. 134

BURNER KITS _____ p. 137

SPECIAL CONFIGURATIONS _____ p. 137

N10 | GAS RANGE

TWO STAGE PROGRESSIVE/MODULATING ELECTRONIC

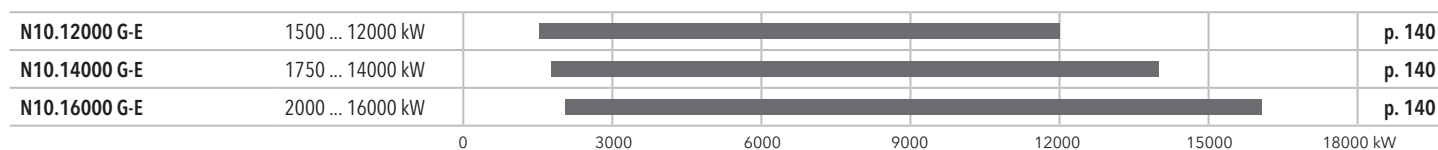

TWO STAGE PROGRESSIVE/MODULATING ELECTRONIC Low NOx

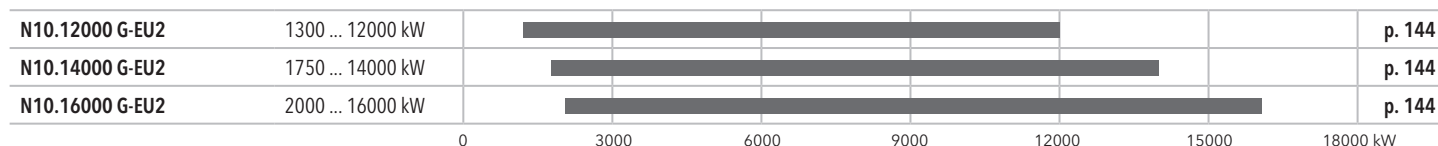

N10 | DUAL FUEL RANGE (GAS/LIGHT OIL)

TWO STAGE PROGRESSIVE/MODULATING ELECTRONIC IN GAS AND IN LIGHT OIL



TWO STAGE PROGRESSIVE/MODULATING ELECTRONIC IN GAS AND IN LIGHT OIL Low NOx

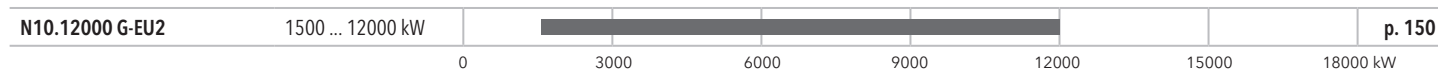

N10 | LIGHT OIL RANGE

TWO STAGE PROGRESSIVE/MODULATING ELECTRONIC



TWO STAGE PROGRESSIVE/MODULATING ELECTRONIC Low NOx

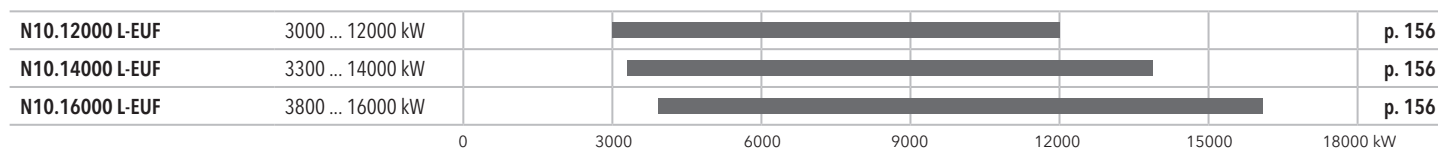

RANGE OVERVIEW

HO-TRON | HEAVY OIL RANGE

ONE STAGE

HO-TRON 0.135	68 ... 136 kW		p. 160
HO-TRON 0.225	108 ... 227 kW		p. 160
HO-TRON 1.350	170 ... 340 kW		p. 162

TWO STAGES

HO-TRON 1.350 Z	205 ... 410 kW		p. 162
HO-TRON 2.580 Z	205 ... 570 kW		p. 162
HO-TRON 2.930 Z	464 ... 930 kW		p. 164
HO-TRON 2.1400 Z	682 ... 1395 kW		p. 164
HO-TRON 3.1700 Z	682 ... 1700 kW		p. 166
HO-TRON 3.2100 Z	682 ... 2093 kW		p. 166
HO-TRON 4.3000 Z	1000 ... 3000 kW		p. 168
HO-TRON 4.3900 Z3	1300 ... 3900 kW		p. 168

TWO STAGE PROGRESSIVE/MODULATING MECHANICAL

HO-TRON 4.3000 R	1000 ... 3000 kW		p. 170
HO-TRON 4.3900 R	1300 ... 3900 kW		p. 170
HO-TRON 5.5000 R	1578 ... 5000 kW		p. 172
HO-TRON 5.5800 R	1795 ... 5800 kW		p. 172
HO-TRON 6.7200 R	2417 ... 7250 kW		p. 174
HO-TRON 6.8500 R	2750 ... 8500 kW		p. 174
HO-TRON 6.10500 R	3300 ... 10500 kW		p. 174
HO-TRON 6.13000 R	4367 ... 12500 kW		p. 174
HO-TRON 7.15000 R	5000 ... 15000 kW		p. 176
HO-TRON 7.17000 R	5700 ... 17000 kW		p. 176

GHO-TRON | DUAL FUEL RANGE (GAS/HEAVY OIL)

TWO STAGES

GHO-TRON 3.2100 Z	414 ... 2150 kW		p. 180
-------------------	-----------------	--	--------

TWO STAGE PROGRESSIVE/MODULATING MECHANICAL

GHO-TRON 4.3000 R	630 ... 3000 kW		p. 182
GHO-TRON 4.3900 R	875 ... 3900 kW		p. 182
GHO-TRON 5.5000 R	1200 ... 5000 kW		p. 184
GHO-TRON 5.5800 R	1500 ... 5800 kW		p. 184
GHO-TRON 6.7200 R	1500 ... 7500 kW		p. 186
GHO-TRON 6.8500 R	2000 ... 8500 kW		p. 186
GHO-TRON 6.10500 R	2500 ... 10500 kW		p. 186
GHO-TRON 6.13000 R	2700 ... 13000 kW		p. 186
GHO-TRON 7.15000 R	3690 ... 15000 kW		p. 188
GHO-TRON 7.17000 R	4000 ... 17000 kW		p. 188

RANGE OVERVIEW

D-TRON | DUOBLOCK RANGE

TWO STAGES, TWO STAGE PROGRESSIVE/MODULATING MECHANICAL OR ELECTRONIC p. 192

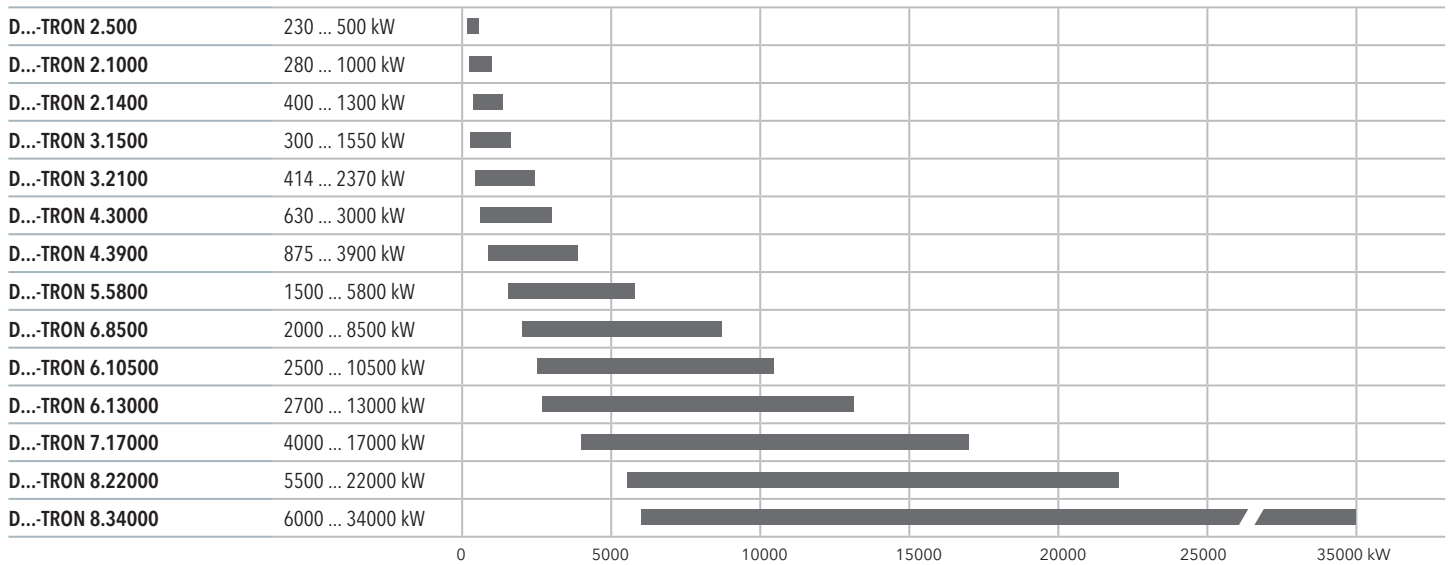

EK-DUO | DUOBLOCK RANGE

TWO STAGE PROGRESSIVE/MODULATING ELECTRONIC p. 194

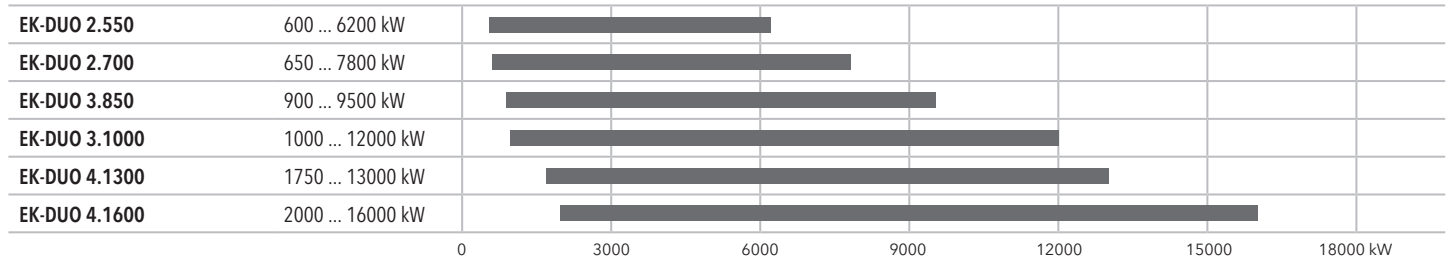

RPD | DUOBLOCK RANGE

TWO STAGE PROGRESSIVE/MODULATING MECHANICAL OR ELECTRONIC p. 196

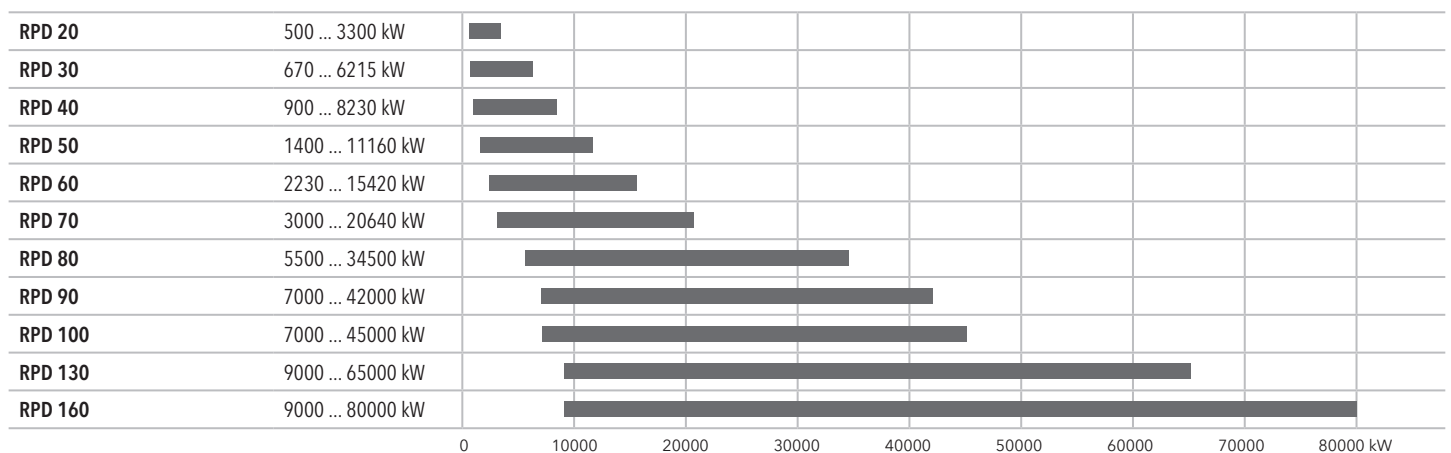

GAS TRAINS

NEXTRON - mechanical versions	p. 198
NEXTRON - pneumatic versions	p. 199
EK EVO and NEXTRON - electronic versions	p. 200
N10 - electronic versions	p. 202
GHO-TRON - mechanical versions	p. 203

CONTROL UNITS

BT300	p. 204
ETAMATIC	p. 205

OPTIONS

GAS	p. 206
LIGHT OIL	p. 212
FREQUENCY CONVERTER	p. 218

Monoblock burners from 250 to 13500 kW Gas and dual fuel



Robust and professional structure

The design of the EKEVO® is the result of a successful synergy between ELCO key features and essential design. EKEVO® introduces a brand new aluminium casting body and confirms the choice of ELCO about light colors and harmony of each shape. Professionals will appreciate the flexibility of a 180° orientable air inlet, the compact switch box and the easy to clean glossy paint.

Electronics: easy and comprehensive

All EKEVO® models are fully electronically controlled and they are equipped with the exclusive ELCO man-machine interface allowing simple and effective programming operations.



A total advantage in terms of flexibility

The EKEVO® are characterized by their total flexibility of installation; they have been designed to be installed in different ways: up-firing, down-firing, upside-down or side-to-side (twin chamber boilers). Options and configurations have been foreseen in order to fulfill any application need.

Smart solutions for easy maintenance

The maintenance of the EKEVO® burners can comfortably be carried out thanks to a wide opening above the housing, allowing easy access to the combustion components up to the fan, and thanks to the choice of the material: aluminium, lightweight to handle and resistant at the same time. Maintenance operations are possible keeping the original combustion components setup.



MAIN TECHNICAL FEATURES

- Two stage progressive/modulating forced draught burner
- Fuels:
 - natural gas, low calorific value 6,99...11,39 kWh/Nm³
 - LPG, low calorific value 25,89 kWh/Nm³
 - light oil, viscosity 6 mm²/s at 20°C, low calorific value 11,86 kWh/kg
- Combustion technology:
 - Low NOx class 2 (<120 mg/kWh) and class 3 (<80 mg/kWh) in gas operation according to EN676
 - Low NOx class 2 (<185 mg/kWh) and class 3 (<120 mg/kWh) in light oil operation according to EN267
- Integrated switch cabinet (ISC System) with modular concept complete for an easy installation with:
 - BT300 control box
 - fan motor direct start-up
 - enumerated connection terminals
 - three-phase electrical power supply
 - available as options: power regulator, speed controller, O₂/CO regulator and BUS interface
- Innovative design allowing easy access to burner components for fast start-up and reduced maintenance time and space
- Three flame tube lengths available
- Orientable air intake box
- Secured burner head adjustments during maintenance (RTC System)
- Closing of the air damper on burner shut-down
- Multiple gas train matching according to the inlet gas pressure
- Gas train factory assembled and tested for tightness and electrical security
- Products are in compliance with EN676 and EN267 European standards and with the following directives:
 - 2014/35/UE Low Voltage Directive
 - 2014/30/UE EMC Directive
 - 2009/142/CEE Gas Appliances Directive
 - 2006/42/EC Machinery Directive
 - 2011/65/EU RoHS2 Directive

RANGE OVERVIEW

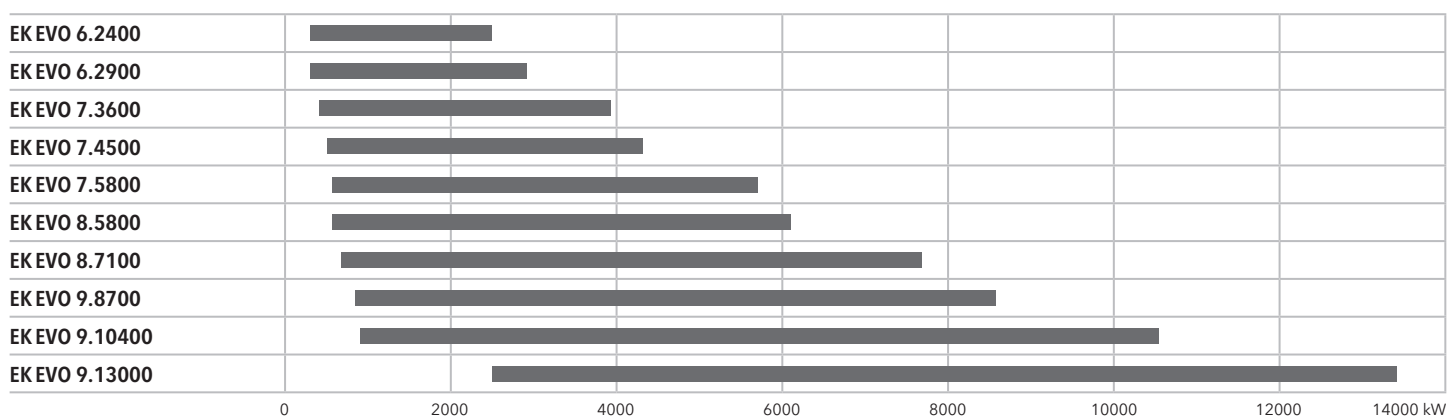

EKEVO 6 G-E, EKEVO 7 G-E

390 ... 5400 kW

2 stage progressive/modulating electronic

- **Fuels:** natural gas, low calorific value 6,99 ... 11,39 kWh/m³;
LPG, low calorific value 25,89 kWh/m³
- **Emission class:** Low NOx class 2 (<120 mg/kWh) according to EN676
- **Electrical power supply:** single-phase 230 V - 50 Hz
- **Protection level:** IP 41



TECHNICAL DATA

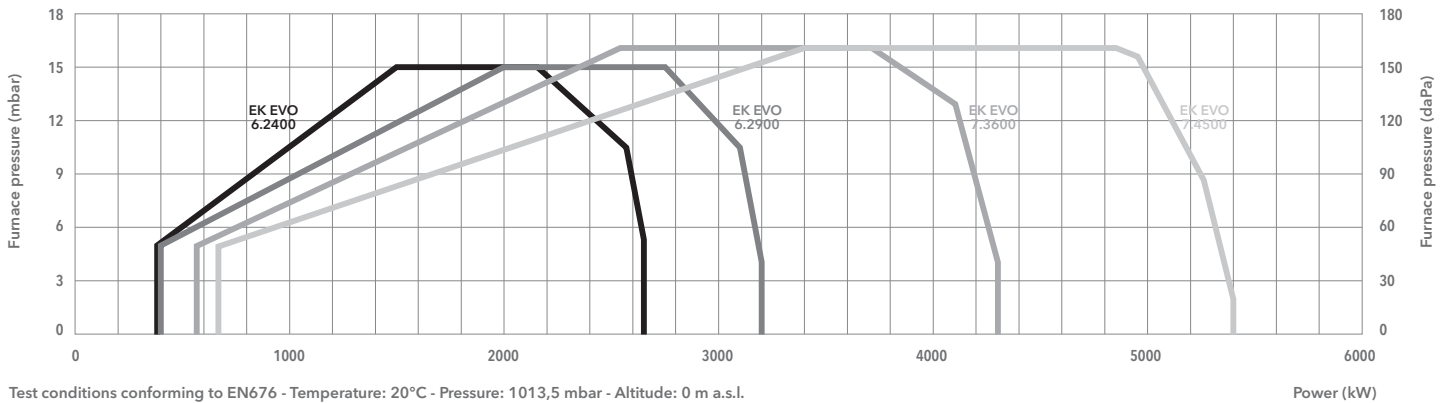

Test conditions conforming to EN676 - Temperature: 20°C - Pressure: 1013,5 mbar - Altitude: 0 m a.s.l.

	EKEVO 6.2400 G-E	EKEVO 6.2900 G-E	EKEVO 7.3600 G-E	EKEVO 7.4500 G-E
Operating range	390 - 2650 kW	400 - 3200 kW	580 - 4300 kW	680 - 5400 kW
Gas pressure	50 - 500 mbar (max 360 mbar for d452 and d453 gas train)	55 - 500 mbar (max 360 mbar for d452 and d453 gas train)	60 - 500 mbar (max 360 mbar for d452 and d453 gas train)	65 - 500 mbar (max 360 mbar for d452 and d453 gas train)
Control box / flame detector	BT300 / Ionisation	BT300 / Ionisation	BT300 / Ionisation	BT300 / Ionisation
Auxiliary voltage	1NPE AC 230 V - 50 Hz TN-S	1NPE AC 230 V - 50 Hz TN-S	1NPE AC 230 V - 50 Hz TN-S	1NPE AC 230 V - 50 Hz TN-S
Power supply	3PE AC 400 V - 50 Hz	3PE AC 400 V - 50 Hz	3PE AC 400 V - 50 Hz	3PE AC 400 V - 50 Hz
Fan motor	50 Hz - 3 kW	50 Hz - 4 kW	50 Hz - 5,5 kW	50 Hz - 7,5 kW
Acoustic level	<75 dB(A)	<77 dB(A)	<81 dB(A)	<82,5 dB(A)
CE certificate	0085CL0215	0085CL0215	0085CL0215	0085CL0215
Burner codes (body + head)	KN	3752745	3752746	3752748
	KM	3752749	3752750	3752752
	KL	3752753	3752754	3752756

GAS TRAINS

DUNGS

Model	Code
GT-d452-1"1/2 (*)	3750510
GT-d453-2" (*)	3750511
GT-d454-65	3750512
GT-d455-80	3750513
GT-d456-100	3750514

SIEMENS

Model	Code
GT-s451-1"1/2	3750525
GT-s452-2"	3750526
GT-s453-65	3750527
GT-s454-80	3750528
GT-s455-100	3750529
GT-s456-125	3750530

FILTERS

Model	Code
FG-Rp1"1/2	3750543
FG-Rp2"	3750544
FG-DN65	3750545
FG-DN80	3750546
FG-DN100	3750547
FG-DN125	3750548

*: integrated filter

 **Pressure losses diagrams:** see following pages
Dimensions of gas trains and gas filters: see pag. 200

DIMENSIONS (mm)

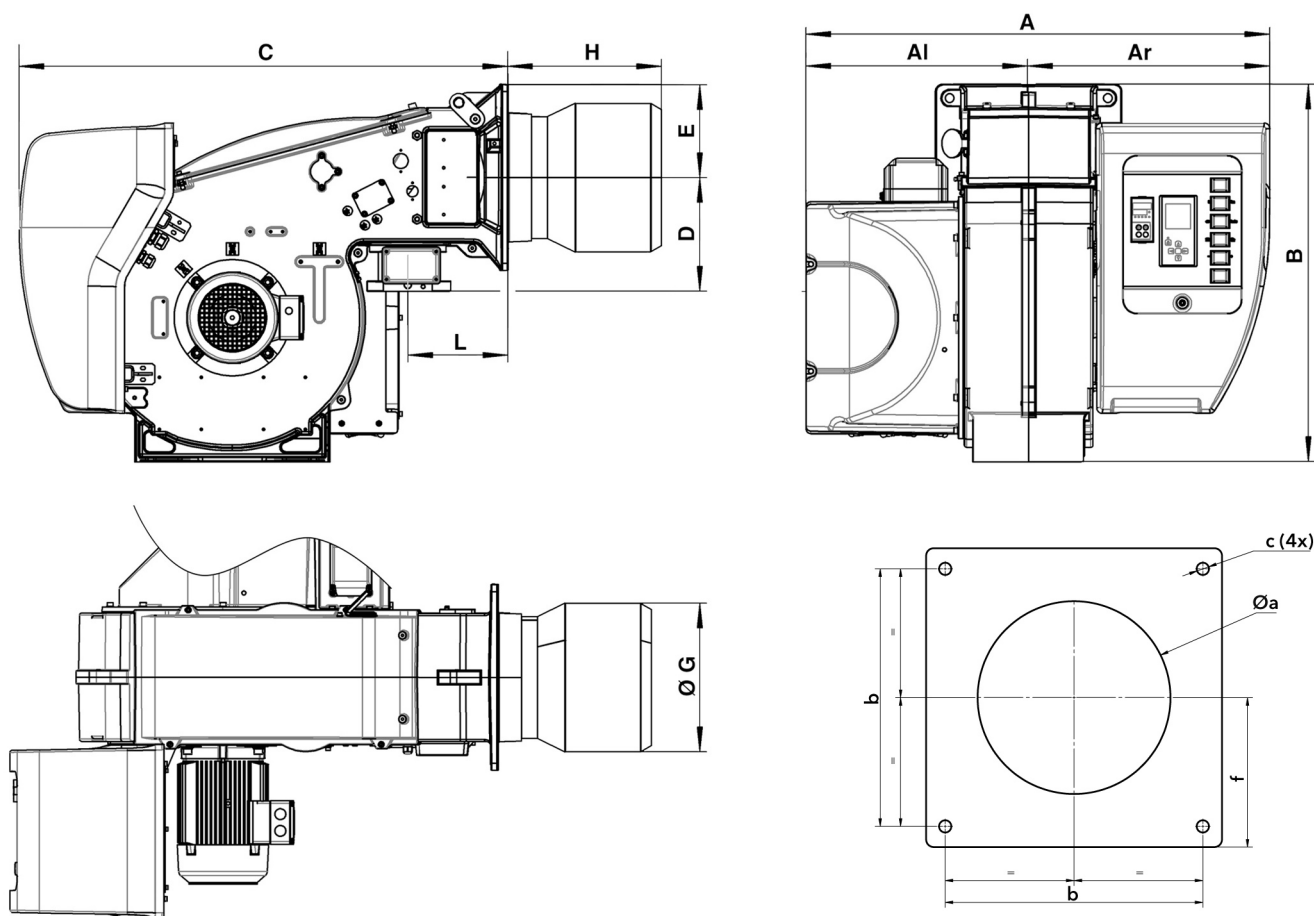

Model	A	AI	Ar	B	C	D	E	ØG	H			L	Øa	b	c	f
									KN	KM	KL					
EKEVO 6	1035	479	556	812	1048	245	200	320	330	450	570	215	330-340	340	M16	200
EKEVO 7	1093	506	587	941	1122	276	235	370	375	505	635	225	380-400	400	M16	235

PACKAGING

The burner is delivered in 2 packages containing:

- burner body with mounted combustion head, boiler fixing accessories and technical documentation;
- gas train and filter.

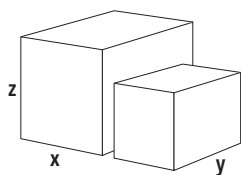

Models	Dimensions (mm)			Gross weight (kg)	
	X	Y	Z		
EK EVO 6.2400 G-E	KN	2070	1420	990	168
	KM	2070	1420	990	170
	KL	2070	1420	990	172
EK EVO 6.2900 G-E	KN	2070	1420	990	174
	KM	2070	1420	990	176
	KL	2070	1420	990	178
EK EVO 7.3600 G-E	KN	2070	1420	1130	212
	KM	2070	1420	1130	214
	KL	2070	1420	1130	216
EK EVO 7.4500 G-E	KN	2070	1420	1130	218
	KM	2070	1420	1130	220
	KL	2070	1420	1130	222

PRESSURE LOSSES (BURNER HEAD + GAS TRAIN)

EK EVO 6.2400 G-E

DUNGS

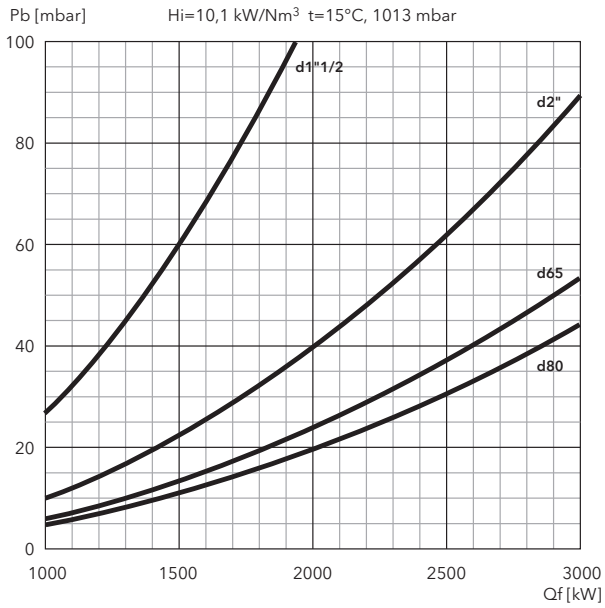

SIEMENS

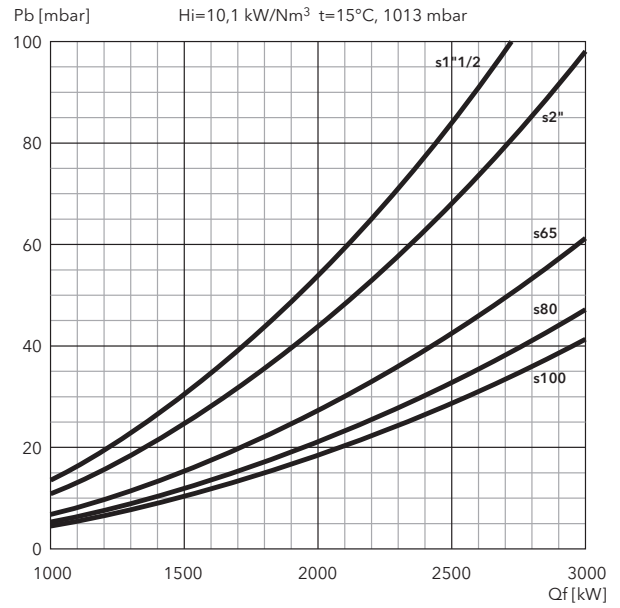

EK EVO 6.2900 G-E

DUNGS

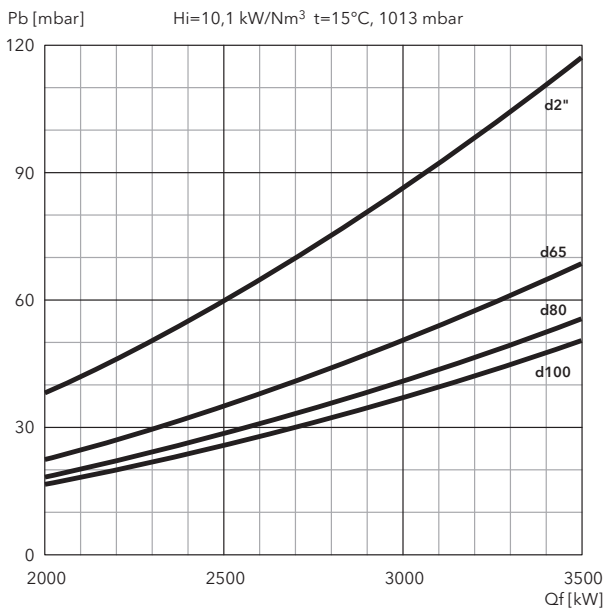

SIEMENS

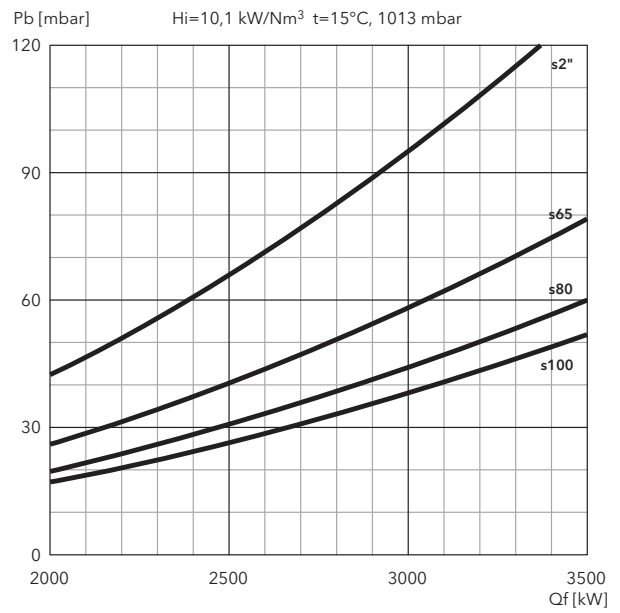

FILTERS

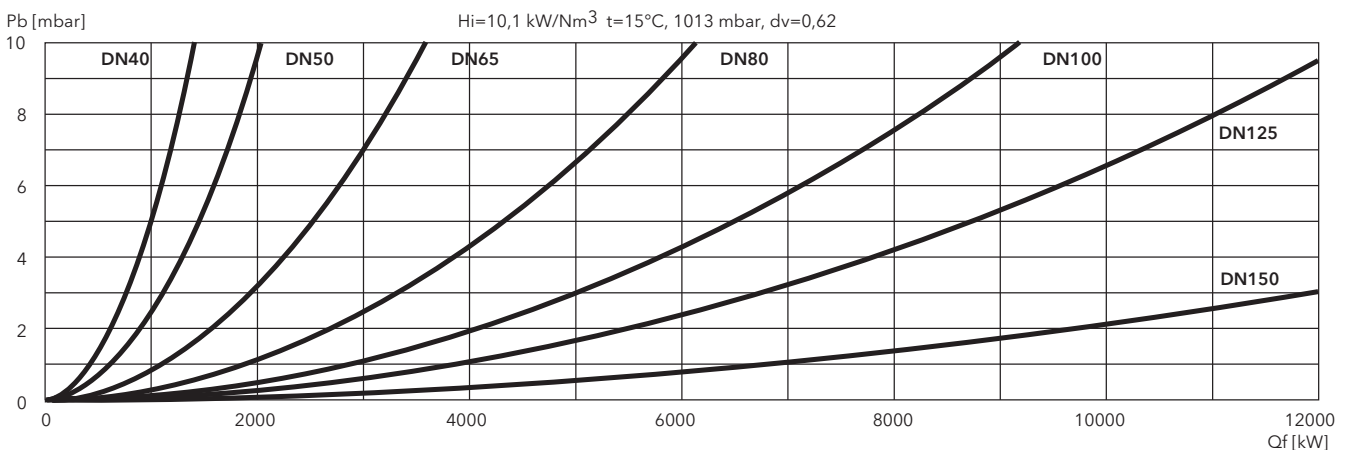

PRESSURE LOSSES (BURNER HEAD + GAS TRAIN)

EK EVO 7.3600 G-E

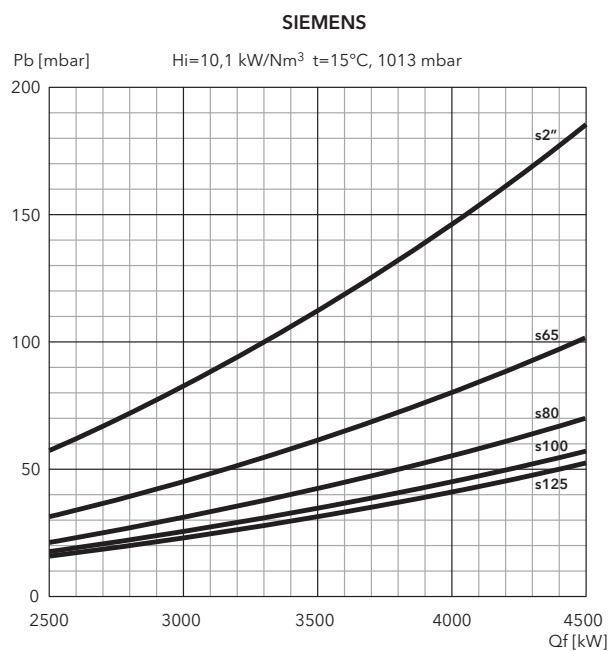
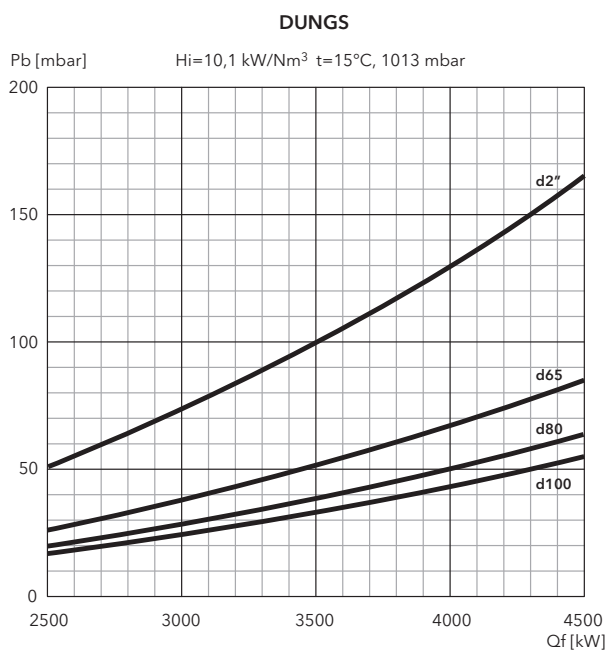

EK EVO 7.4500 G-E

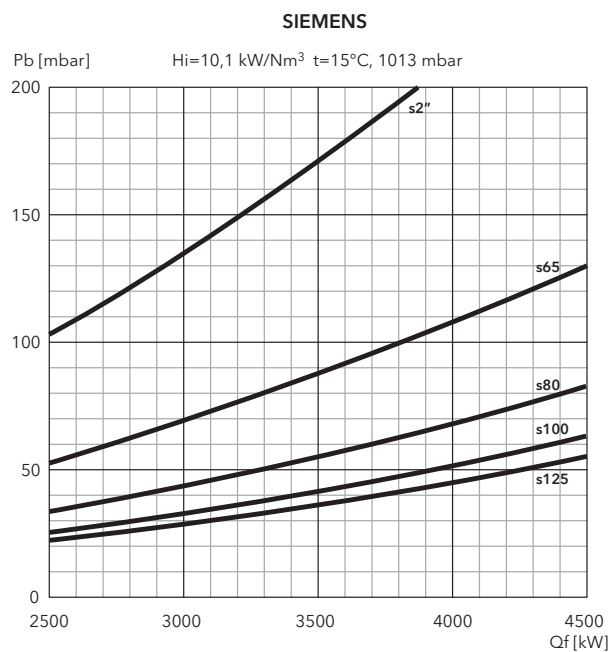
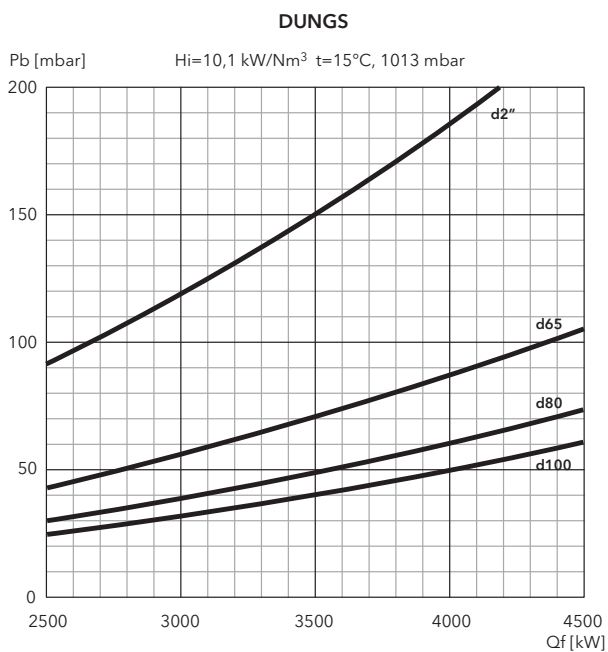

FILTERS

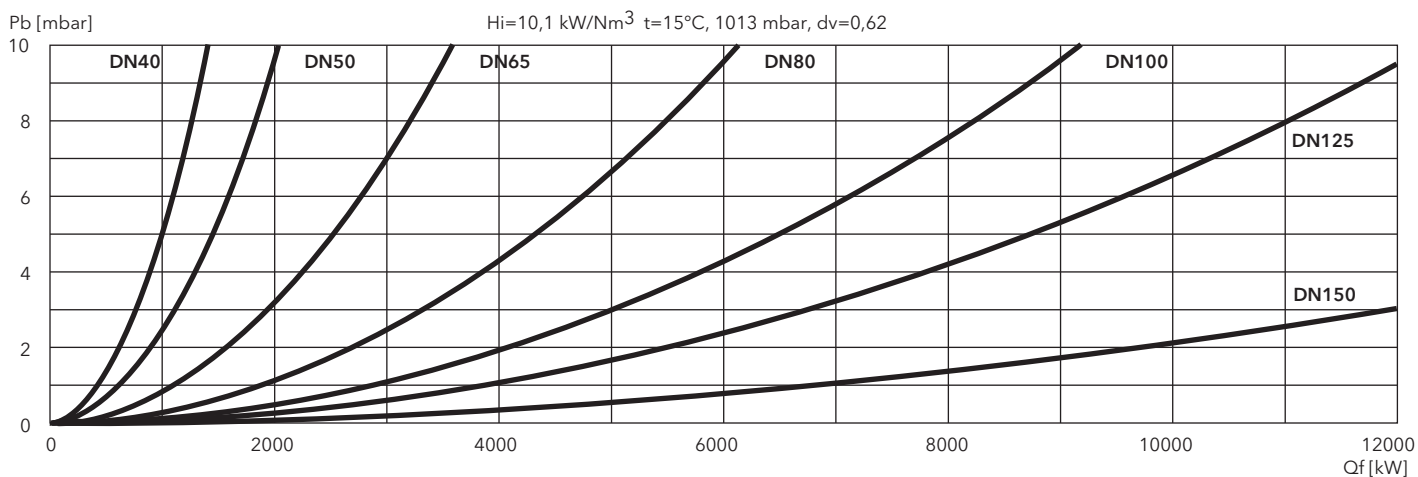

EKEVO 8 G-E, EKEVO 9 G-E

610 ... 11230 kW

2 stage progressive/modulating electronic

- **Fuels:** natural gas, low calorific value 6,99 ... 11,39 kWh/m³;
LPG, low calorific value 25,89 kWh/m³
- **Emission class:** Low NOx class 2 (<120 mg/kWh) according to EN676
- **Modulating ratio:** 1:10
- **Electrical power supply:** single-phase 230 V - 50 Hz
- **Protection level:** IP 41

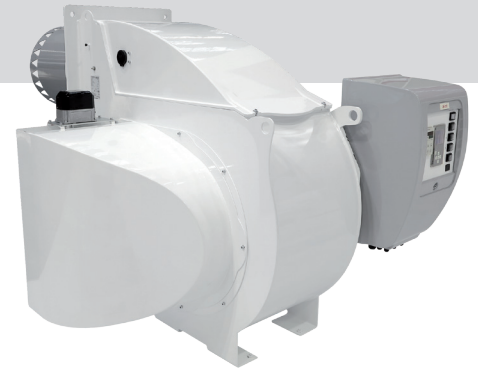

TECHNICAL DATA

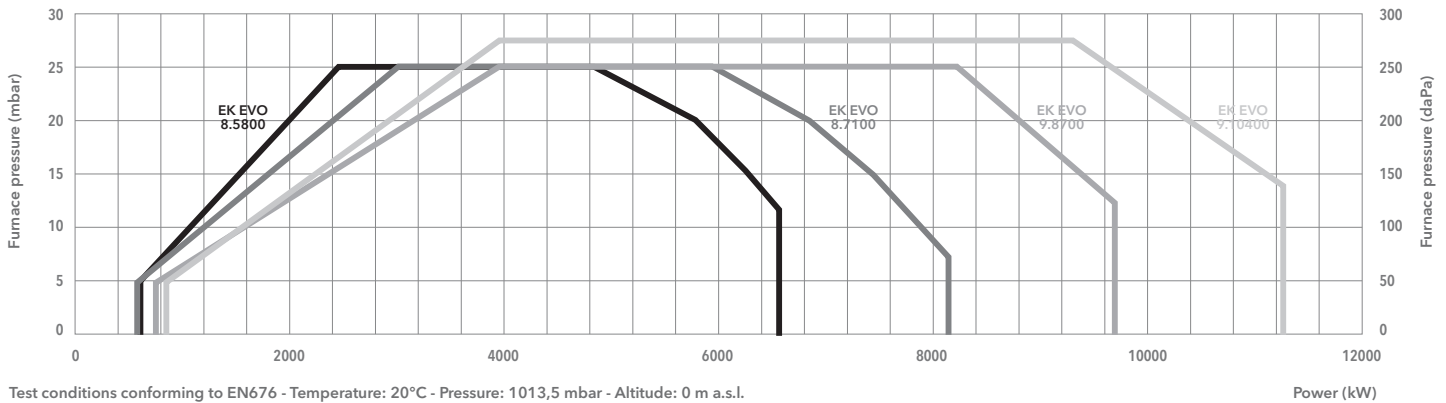

Test conditions conforming to EN676 - Temperature: 20°C - Pressure: 1013,5 mbar - Altitude: 0 m a.s.l.

	EKEVO 8.5800 G-E	EKEVO 8.7100 G-E	EKEVO 9.8700 G-E	EKEVO 9.10400 G-E
Operating range	620 - 6570 kW	610 - 8150 kW	780 - 9700 kW	850 - 11230 kW
Gas pressure	60 - 500 mbar (60 - 360 mbar for d457)		70 - 500 mbar (70 - 360 mbar for d457)	
Control box / flame detector	BT300 / Ionisation		BT300 / Ionisation	
Auxiliary voltage	1NPE AC 230 V - 50 Hz TN-S		1NPE AC 230 V - 50 Hz TN-S	
Power supply	3PE AC 400 V - 50 Hz		3PE AC 400 V - 50 Hz	
Fan motor	50 Hz - 11 kW	50 Hz - 15 kW	50 Hz - 18,5 kW	50 Hz - 22 kW
Acoustic level	<80,3 dB(A)	<81 dB(A)	<84,8 dB(A)	<86,3 dB(A)
CE certificate	00850CL0215		00850CL0215	
Burner codes (body + head)	KN	3753965	3753966	3753967
	KM	3753974	3753975	3753976
	KL	3753982	3753983	3753984

GAS TRAINS

DUNGS

Model	Code
GT-d457-2" (*)	3750515
GT-d458-65	3750516
GT-d459-80	3750517
GT-d460-100	3750518

SIEMENS

Model	Code
GT-s457-2"	3750537
GT-s458-65	3750538
GT-s459-80	3750539
GT-s460-100	3750540
GT-s461-125	3750541

FILTERS

Model	Code
FG-Rp2"	3750544
FG-DN65	3750545
FG-DN80	3750546
FG-DN100	3750547
FG-DN125	3750548

*: integrated filter

i **Pressure drops graphs:** see following pages
Dimensions of gas trains and gas filters: see pag. 201

DIMENSIONS (mm)

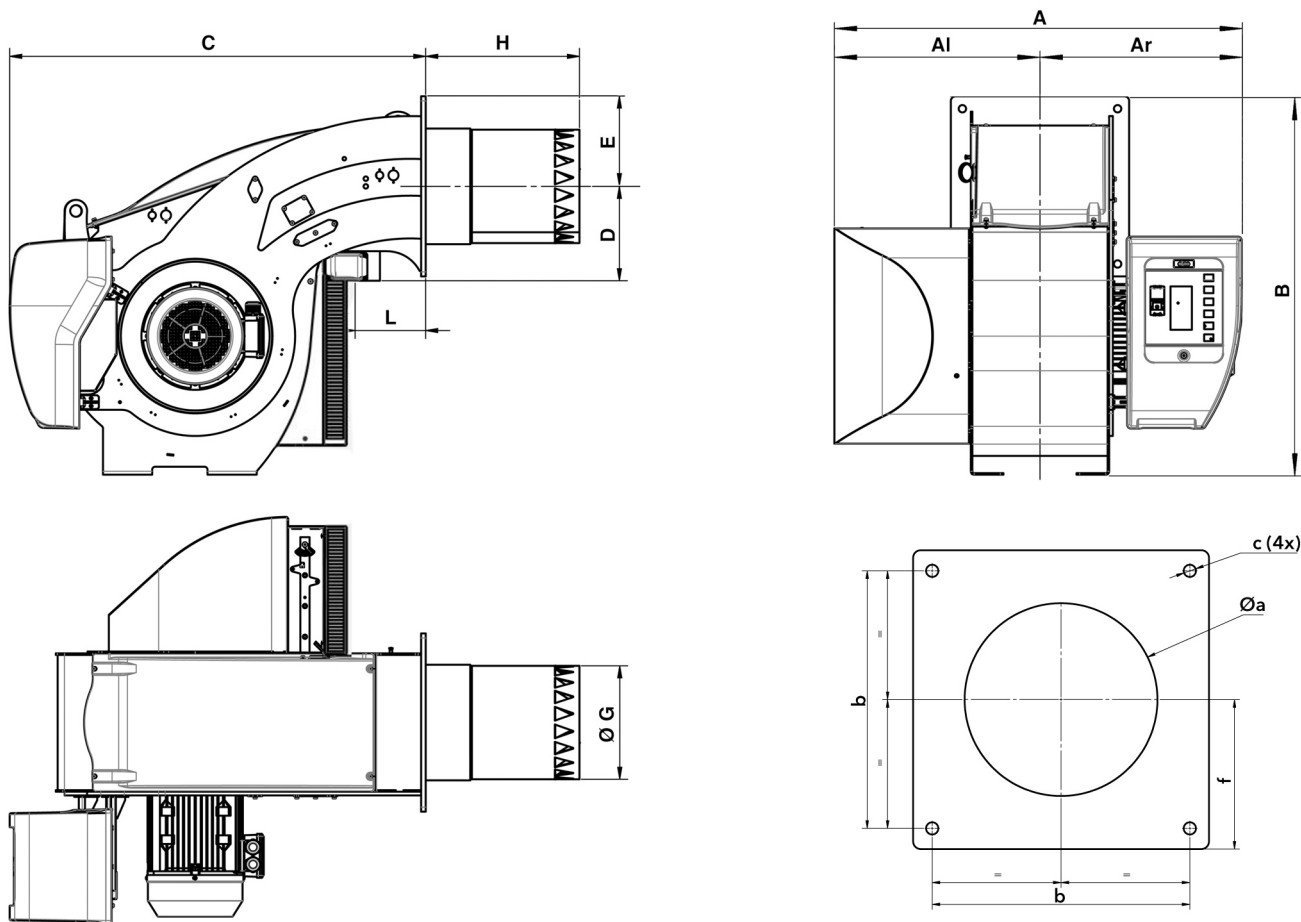

Model	A	AI	Ar	B	C	D	E	ØG	H			L	Øa	b	c	f
									KN	KM	KL					
EKEVO 8	1336	670	666	1226	1354	307	288	376	500	640	780	230	390-410	505	M20	293
EKEVO 9	1400	670	730	1291	1325	332	293	439	550	700	850	230	460-480	505	M20	293

PACKAGING

- The burner is delivered in 2 packages containing:
- burner body with mounted combustion head, boiler fixing accessories and technical documentation;
 - gas train and filter.

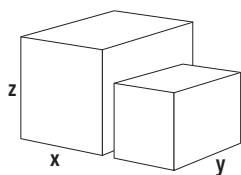

Models	Dimensions (mm)			Gross weight (kg)	
	X	Y	Z		
EK EVO 8.5800 G-E	KN	2300	1500	1396	481
	KM	2300	1500	1396	487
	KL	2300	1500	1396	498
EK EVO 8.7100 G-E	KN	2300	1500	1396	497
	KL	2300	1500	1396	514
EK EVO 9.8700 G-E	KN	2300	1500	1461	524
	KM	2300	1500	1461	532
	KL	2300	1500	1461	539
EK EVO 9.10400 G-E	KN	2300	1500	1461	546
	KM	2300	1500	1461	553
	KL	2300	1500	1461	565

PRESSURE LOSSES (BURNER HEAD + GAS TRAIN)

EK EVO 8.5800 G-E

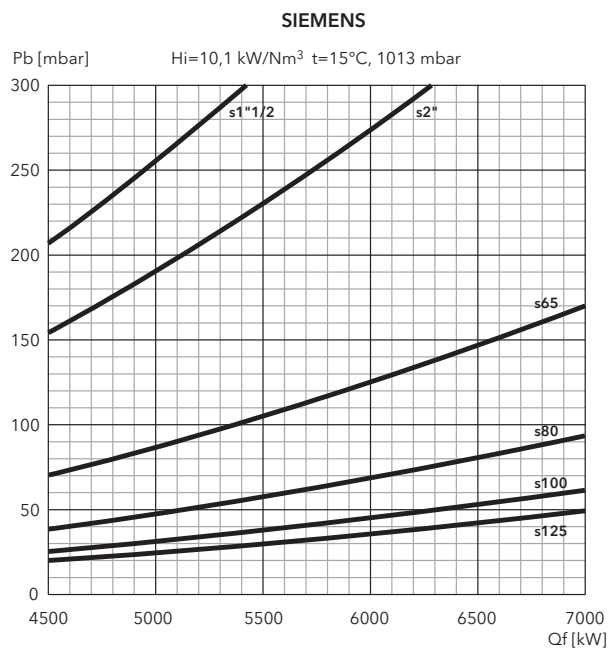
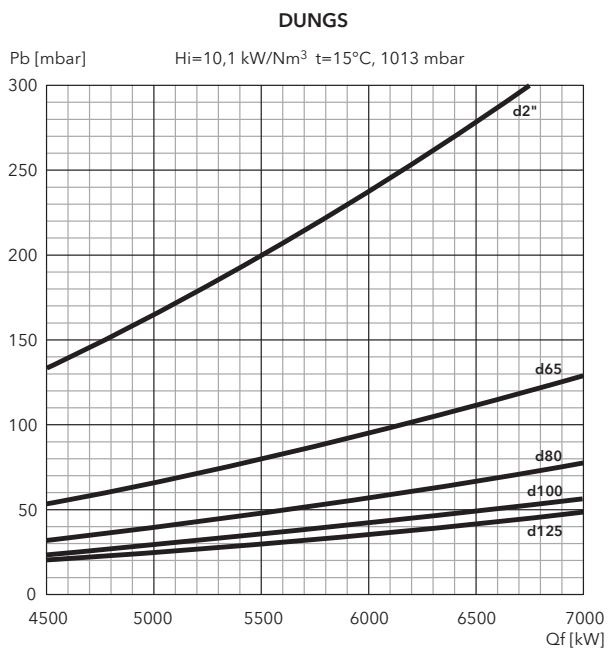

EK EVO 8.7100 G-E

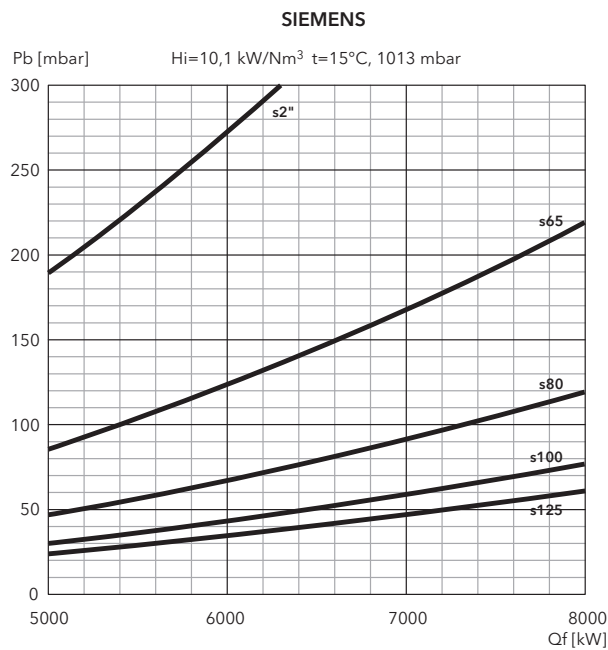
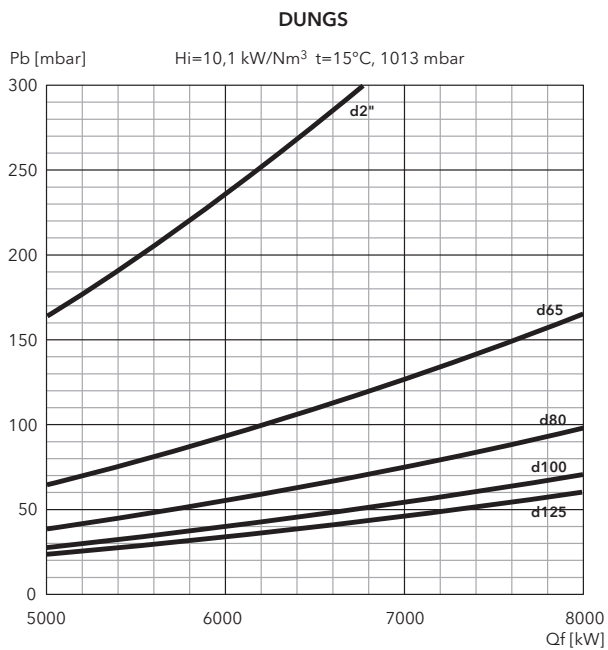

FILTERS

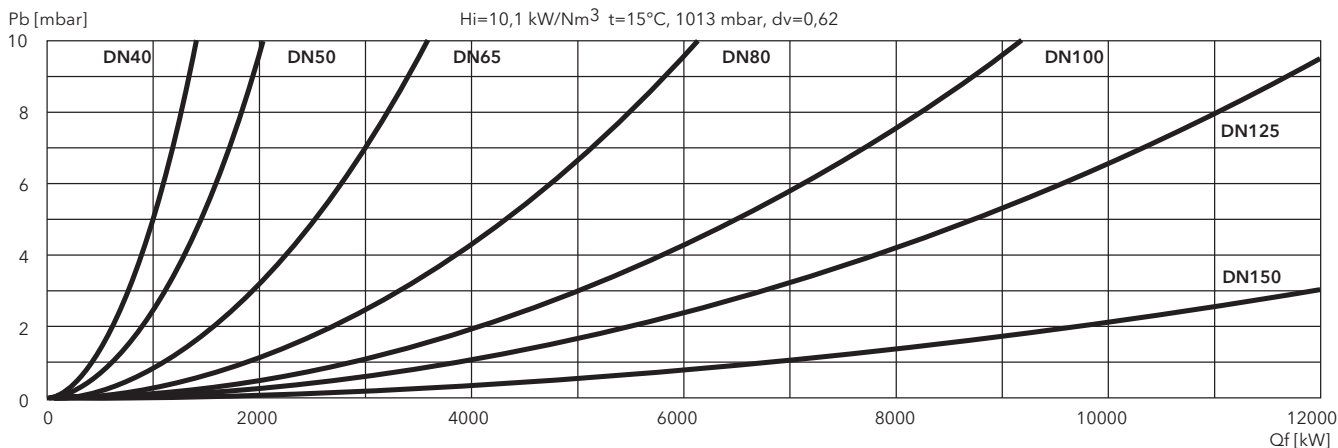

PRESSURE LOSSES (BURNER HEAD + GAS TRAIN)

EK EVO 9.8700 G-E

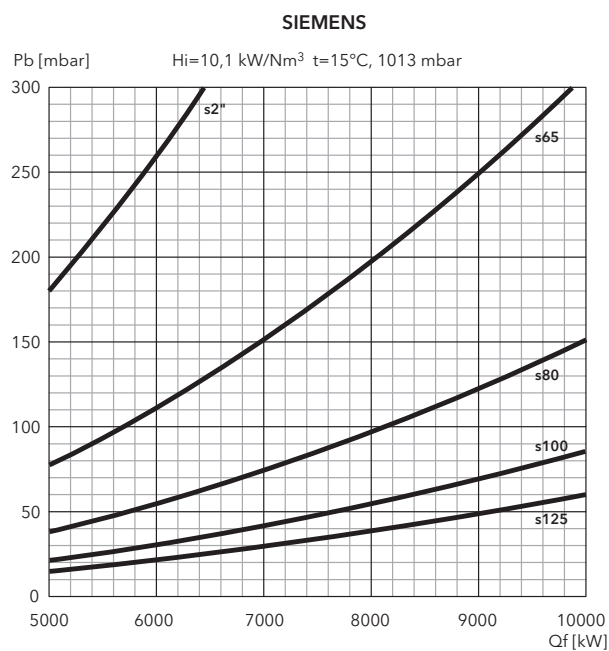
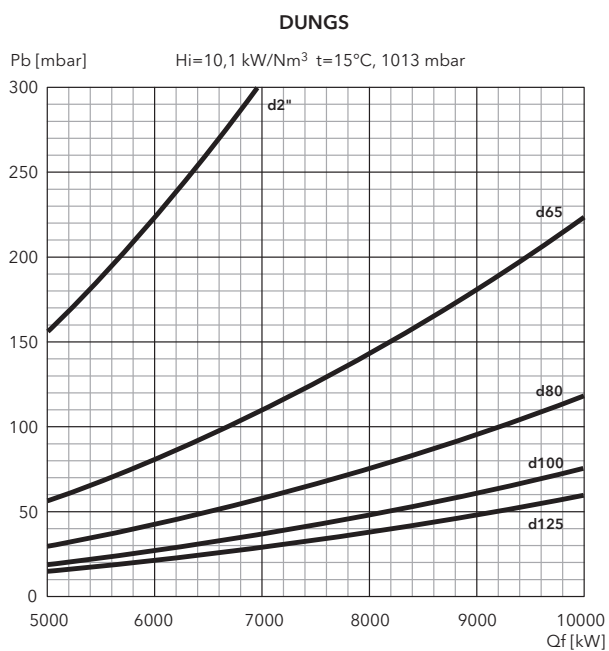

EK EVO 9.10400 G-E

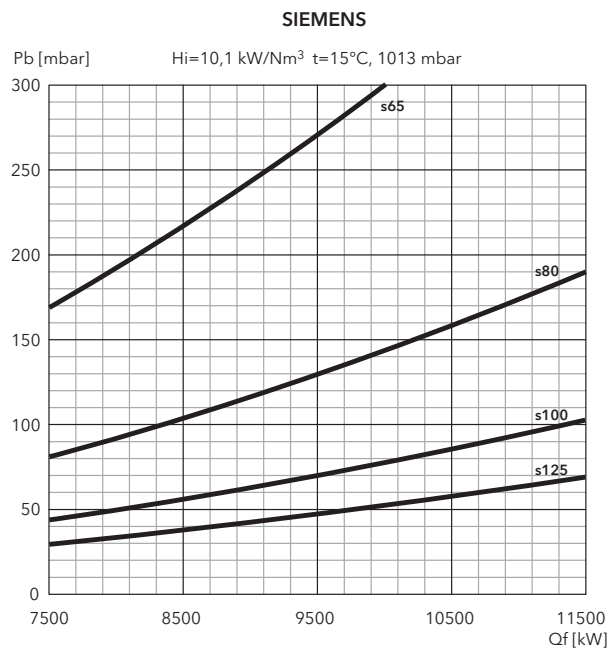
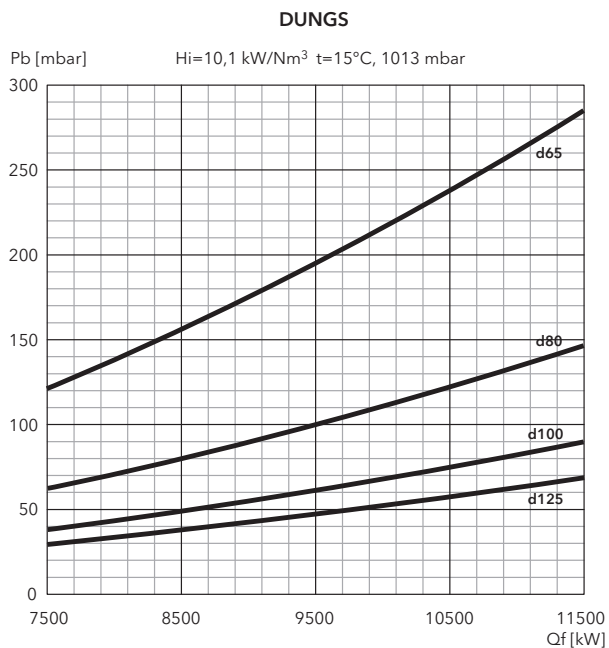

FILTERS

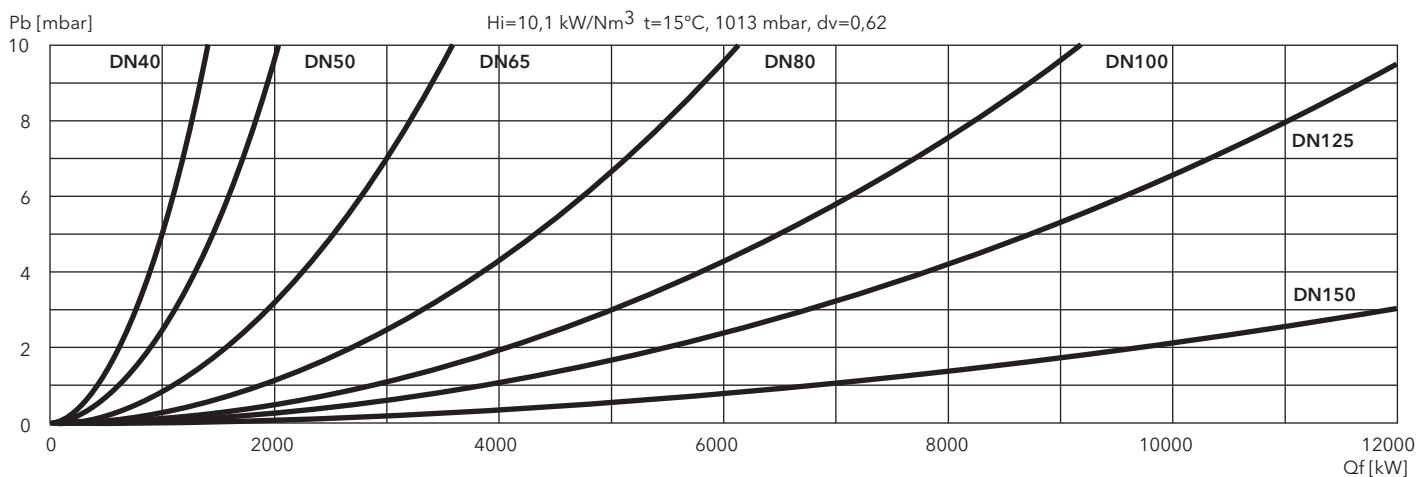

EKEVO 6 G-EF3, EKEVO 7 G-EF3

340 ... 4290 kW
2 stage progressive/modulating electronic (Low NOx class 3)

- **Fuels:** natural gas, low calorific value 6,99 ... 11,39 kWh/m³;
LPG, low calorific value 25,89 kWh/m³
- **Emission class:** Low NOx class 3 (<80 mg/kWh) according to EN676
- **Modulating ratio:** 1:8 (1:7 for model 6.2400)
- **Electrical power supply:** single-phase 230 V - 50 Hz
- **Protection level:** IP 41



TECHNICAL DATA

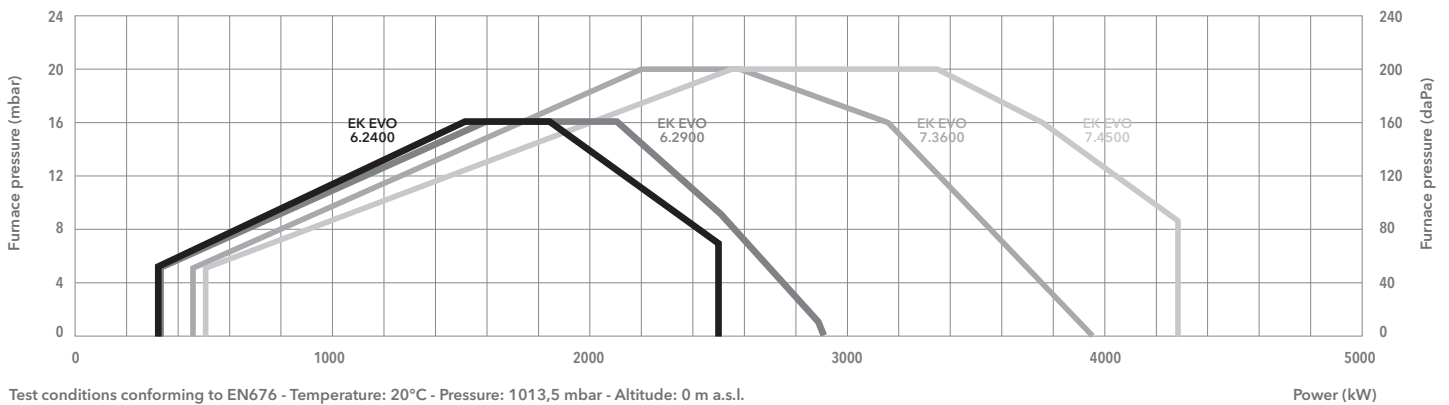

Test conditions conforming to EN676 - Temperature: 20°C - Pressure: 1013,5 mbar - Altitude: 0 m a.s.l.

	EKEVO 6.2400 G-EF3	EKEVO 6.2900 G-EF3	EKEVO 7.3600 G-EF3	EKEVO 7.4500 G-EF3
Operating range	340 - 2500 kW	340 - 2900 kW	470 - 3980 kW	510 - 4290 kW
Gas pressure	50 - 500 mbar (50 - 360 mbar for d452 and d453)			
Control box / flame detector	BT300 / QRA2	BT300 / QRA2	BT300 / QRA2	BT300 / QRA2
Auxiliary voltage	1NPE AC 230 V - 50 Hz TN-S	1NPE AC 230 V - 50 Hz TN-S	1NPE AC 230 V - 50 Hz TN-S	1NPE AC 230 V - 50 Hz TN-S
Power supply	3PE AC 400 V - 50 Hz	3PE AC 400 V - 50 Hz	3PE AC 400 V - 50 Hz	3PE AC 400 V - 50 Hz
Fan motor	50 Hz - 3 kW	50 Hz - 4 kW	50 Hz - 7,5 kW	50 Hz - 7,5 kW
Acoustic level	<74 dB(A)	<77 dB(A)	<83 dB(A)	<81 dB(A)
CE certificate	0085CL0215	0085CL0215	0085CL0215	0085CL0215
Burner codes (body + head)	KN	3754046	3754047	3754049
	KM	3754050	3754051	3754053
	KL	3754054	3754055	3754057

GAS TRAINS

DUNGS

Model	Code
GT-d452-1"1/2 (*)	3750510
GT-d453-2" (*)	3750511
GT-d454-65	3750512
GT-d455-80	3750513
GT-d456-100	3750514

SIEMENS

Model	Code
GT-s451-1"1/2	3750525
GT-s452-2"	3750526
GT-s453-65	3750527
GT-s454-80	3750528
GT-s455-100	3750529
GT-s456-125	3750530

FILTERS

Model	Code
FG-Rp1"1/2	3750543
FG-Rp2"	3750544
FG-DN65	3750545
FG-DN80	3750546
FG-DN100	3750547
FG-DN125	3750548

*: integrated filter

i **Pressure drops graphs:** see following pages
Dimensions of gas trains and gas filters: see pag. 200

DIMENSIONS (mm)

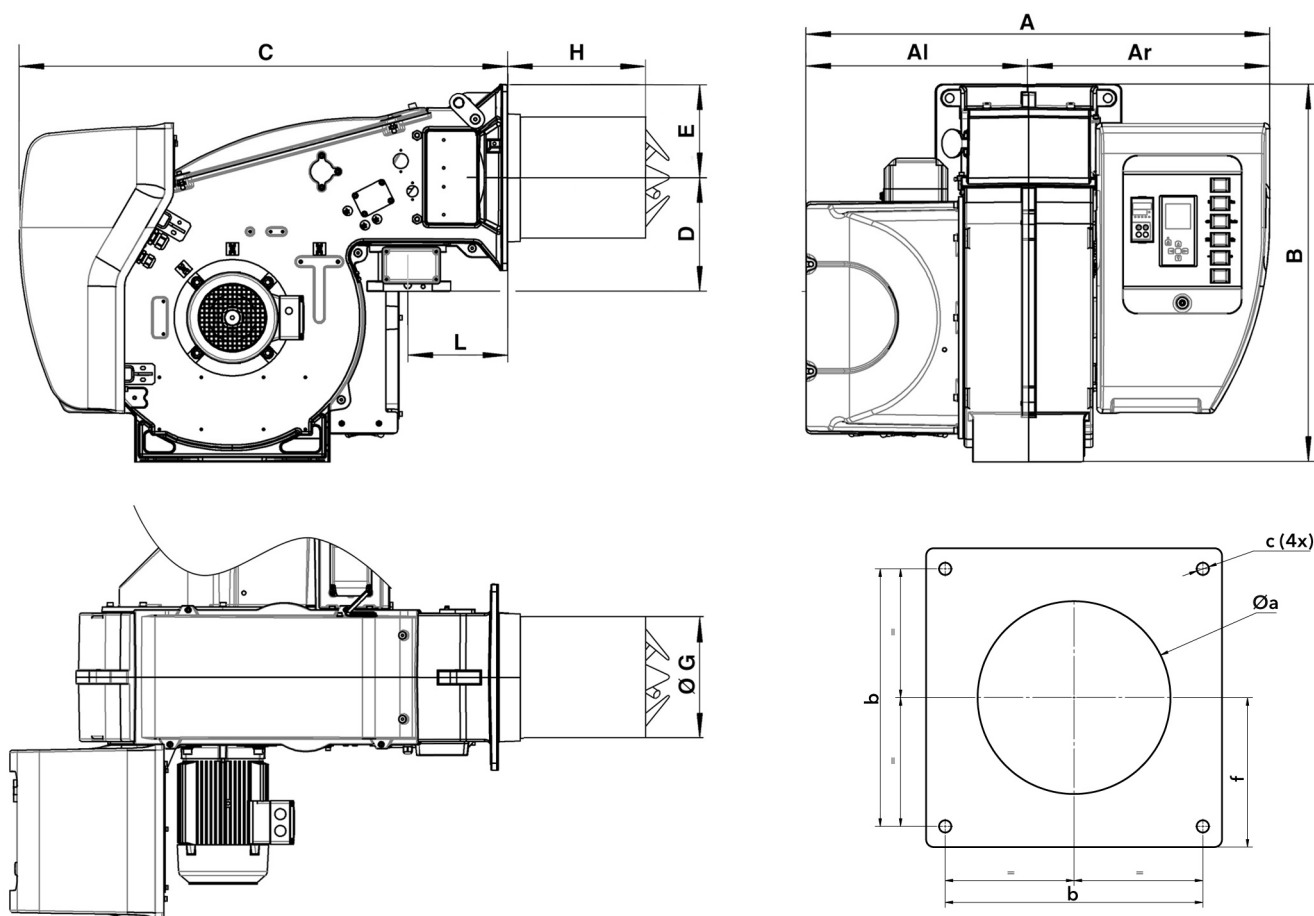

Model	A	Al	Ar	B	C	D	E	ØG	H			L	Øa	b	c	f
									KN	KM	KL					
EKEVO 6	1035	479	556	812	1048	245	200	264	400	520	640	215	300-340	340	M16	200
EKEVO 7	1093	506	587	941	1122	276	235	325	420	550	680	225	360-400	400	M16	235

PACKAGING

- The burner is delivered in 2 packages containing:
- burner body with mounted combustion head, boiler fixing accessories and technical documentation;
 - gas train and filter.

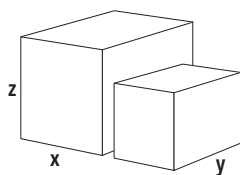

Models	Dimensions (mm)			Gross weight (kg)	
	X	Y	Z		
EK EVO 6.2400 G-EF3	KN	2070	1420	990	168
	KM	2070	1420	990	170
	KL	2070	1420	990	172
EK EVO 6.2900 G-EF3	KN	2070	1420	990	174
	KM	2070	1420	990	176
	KL	2070	1420	990	178
EK EVO 7.3600 G-EF3	KN	2070	1420	1130	218
	KM	2070	1420	1130	220
	KL	2070	1420	1130	222
EK EVO 7.4500 G-EF3	KN	2070	1420	1130	218
	KM	2070	1420	1130	220
	KL	2070	1420	1130	222

PRESSURE LOSSES (BURNER HEAD + GAS TRAIN)

EK EVO 6.2400 G-EF3

DUNGS

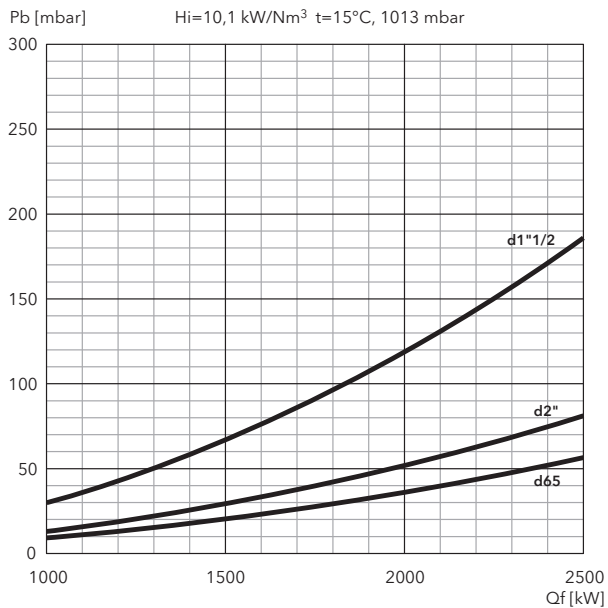

SIEMENS

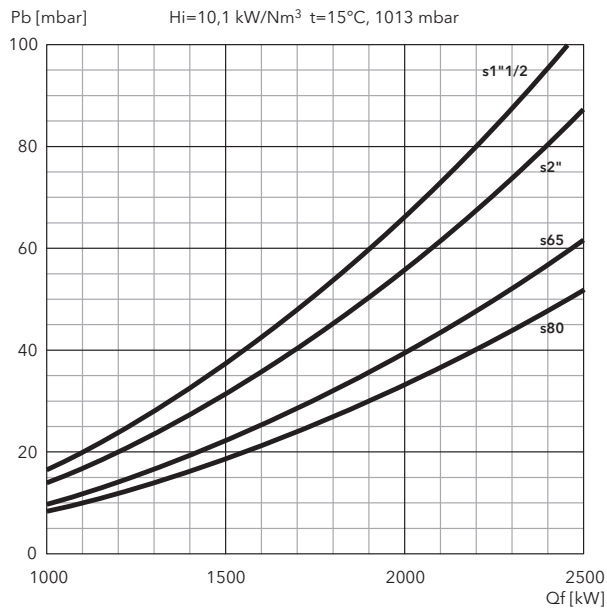

EK EVO 6.2900 G-EF3

DUNGS

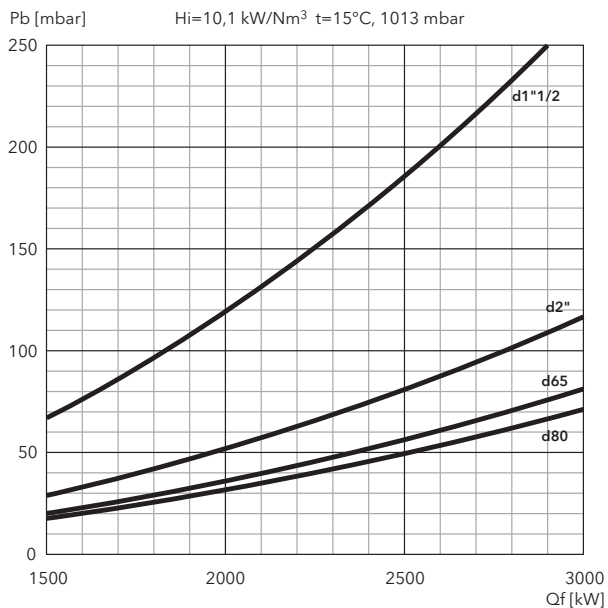

SIEMENS

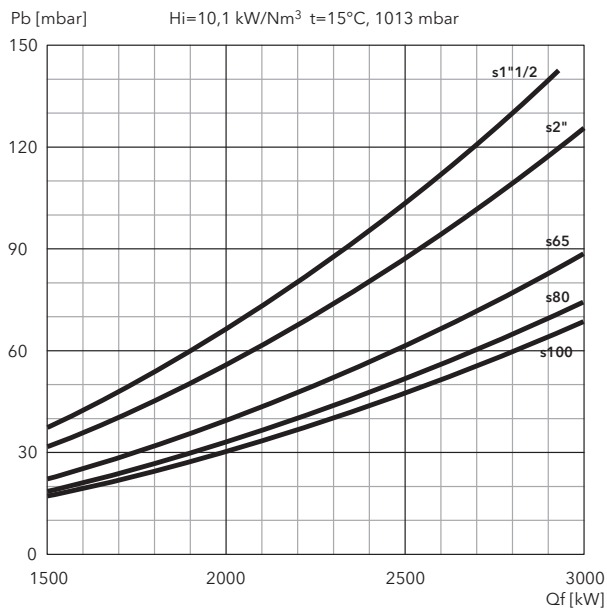

FILTERS

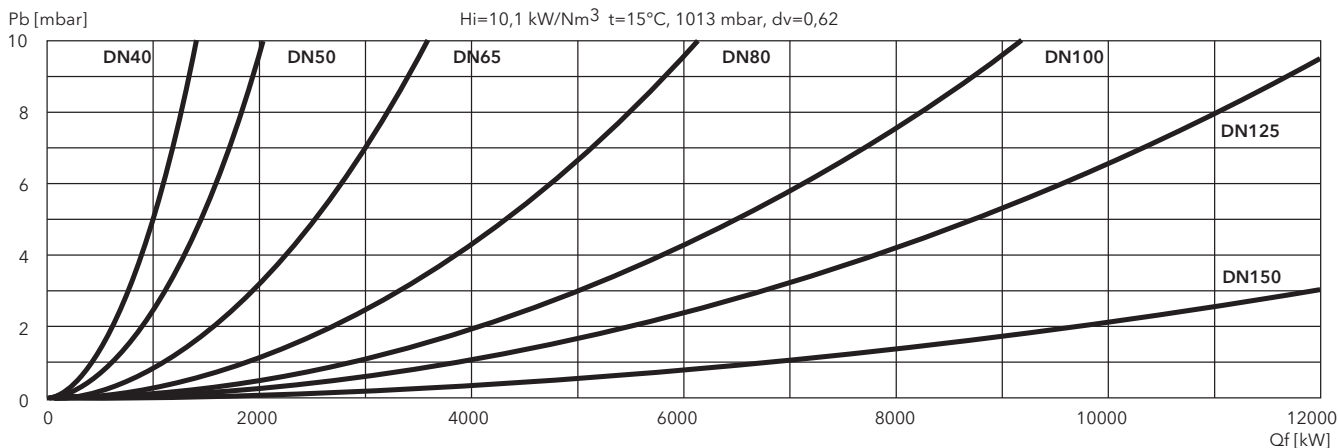

PRESSURE LOSSES (BURNER HEAD + GAS TRAIN)

EK EVO 7.3600 G-EF3

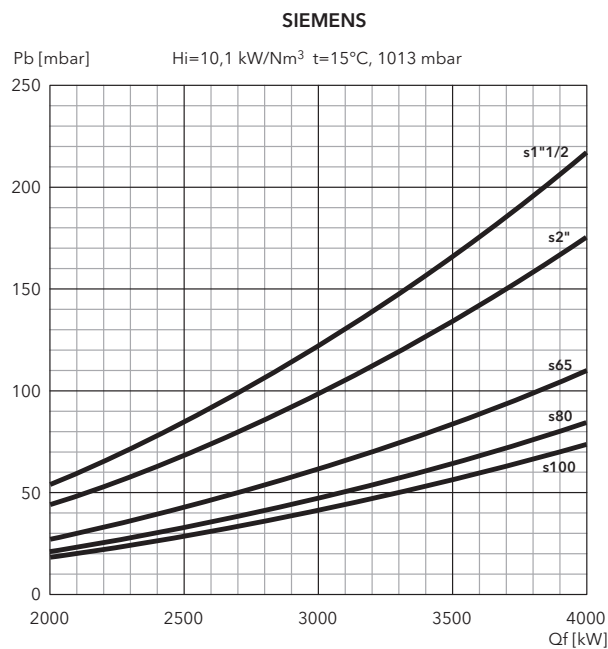
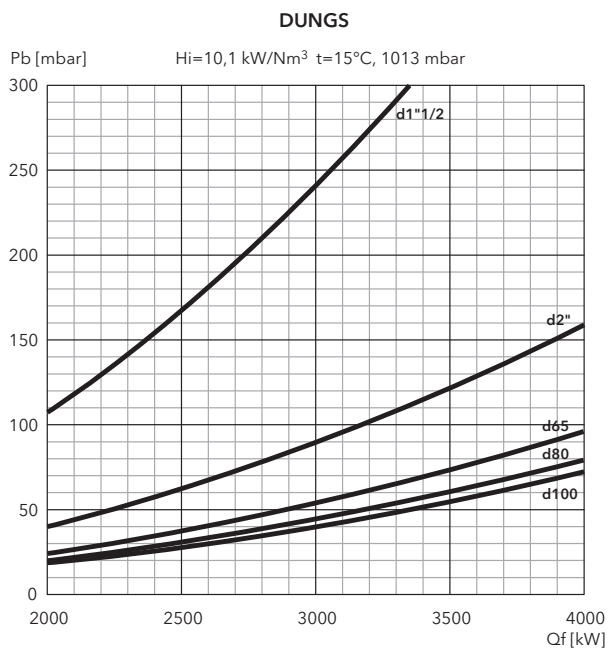

EK EVO 7.4500 G-EF3

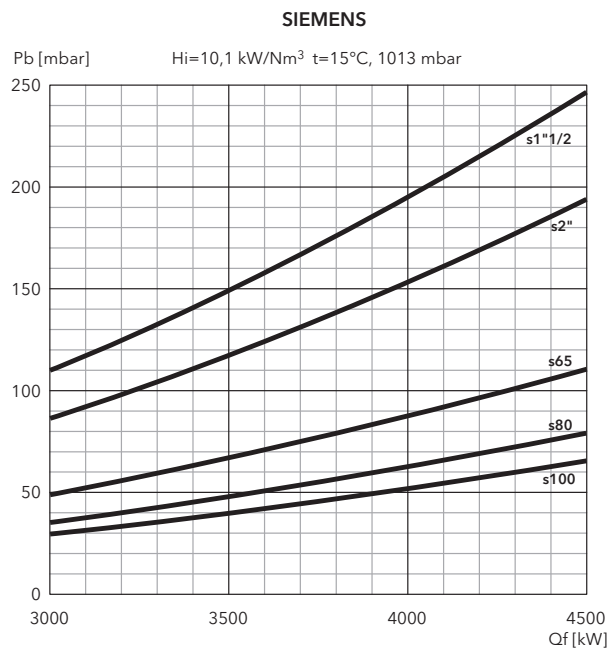
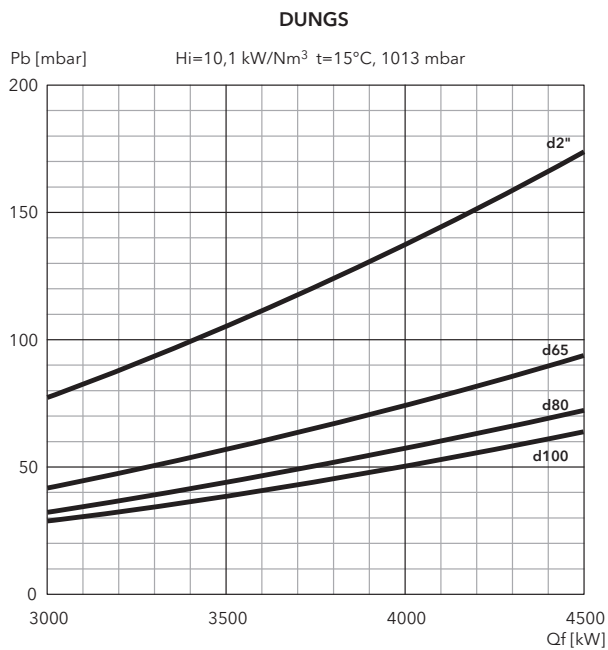

FILTERS

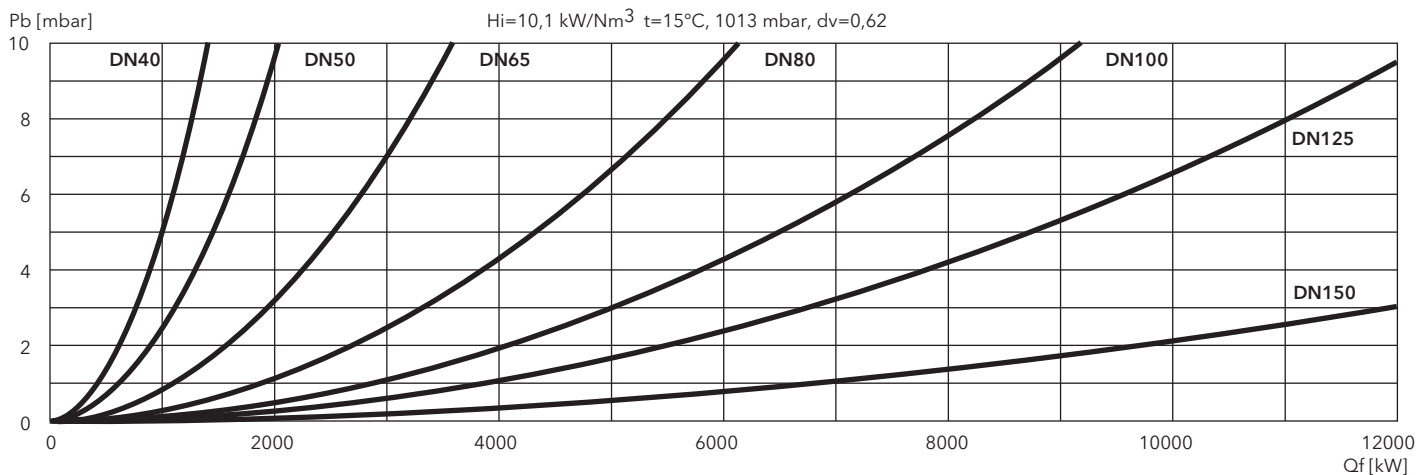

EKEVO 7.5800 G-EU2

600 ... 5850 kW
2 stage progressive/modulating electronic (Low NOx class 3)

- **Fuels:** natural gas, low calorific value 6,99 ... 11,39 kWh/m³;
LPG, low calorific value 25,89 kWh/m³
- **Emission class:** Low NOx class 3 (<80 mg/kWh) according to EN676
- **Electrical power supply:** single-phase 230 V - 50 Hz
- **Protection level:** IP 41



TECHNICAL DATA

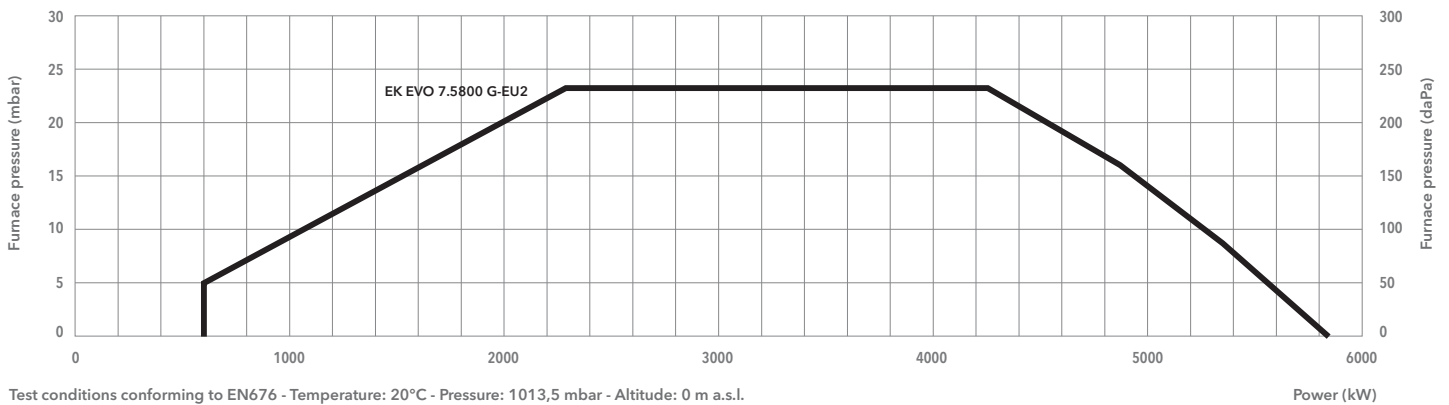

EKEVO 7.5800 G-EU2	
Operating range	600 - 5850 kW
Gas pressure	50 - 500 mbar (50 - 360 mbar for d453)
Control box / flame detector	BT300 / Ionisation
Auxiliary voltage	1NPE AC 230 V - 50 Hz
Power supply	3PE AC 400 V - 50 Hz
Fan motor	50 Hz - 15 kW
Emission grade	Class 3 (<80 mg/kWh)
Acoustic level	<81 dB(A)
CE certificate	0085CLO215

GAS TRAINS

DUNGS

Model	Code
GT-d453-2" (*)	3750511
GT-d454-65	3750512
GT-d455-80	3750513
GT-d456-100	3750514

SIEMENS

Model	Code
GT-s452-2"	3750526
GT-s453-65	3750527
GT-s454-80	3750528
GT-s455-100	3750529
GT-s456-125	3750530

FILTERS

Model	Code
FG-Rp2"	3750544
FG-DN65	3750545
FG-DN80	3750546
FG-DN100	3750547
FG-DN125	3750548

*: integrated filter

 **Pressure drops graphs:** see following pages
Dimensions of gas trains and gas filters: see pag. 200

DIMENSIONS (mm)

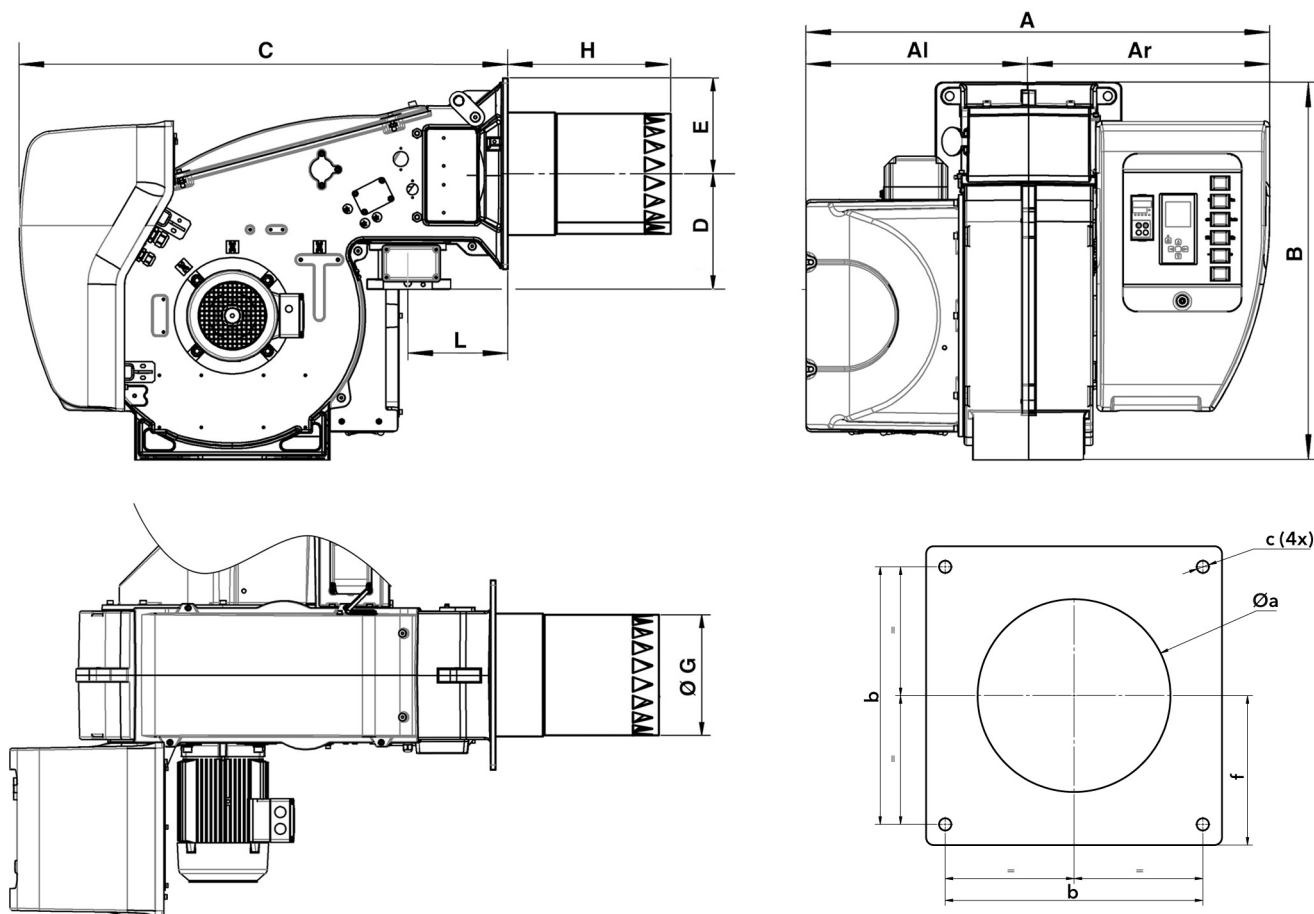

A	Al	Ar	B	C	D	E	ØG	H			L	Øa	b	c	f
								KN	KM	KL					
1093	506	587	941	1122	276	235	325	420	550	680	225	360-400	400	M16	235

PACKAGING

- The burner is delivered in 2 packages containing:
- burner body with mounted combustion head, boiler fixing accessories and technical documentation;
 - gas train and filter.

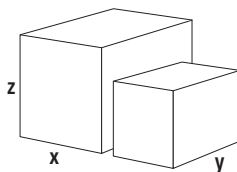

	Dimensions (mm)			Gross weight (kg)
	X	Y	Z	
KN	2070	1420	1130	360
KM	2070	1420	1130	365
KL	2070	1420	1130	370

PRESSURE LOSSES (BURNER HEAD + GAS TRAIN)

EK EVO 7.5800 G-EU2

DUNGS

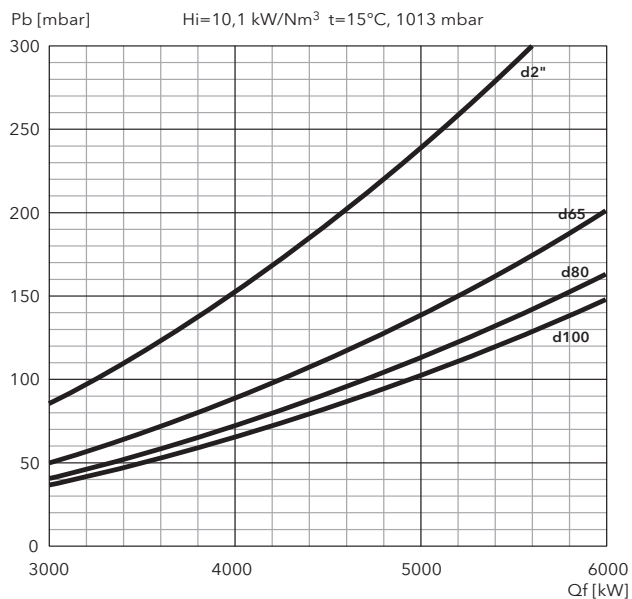

SIEMENS

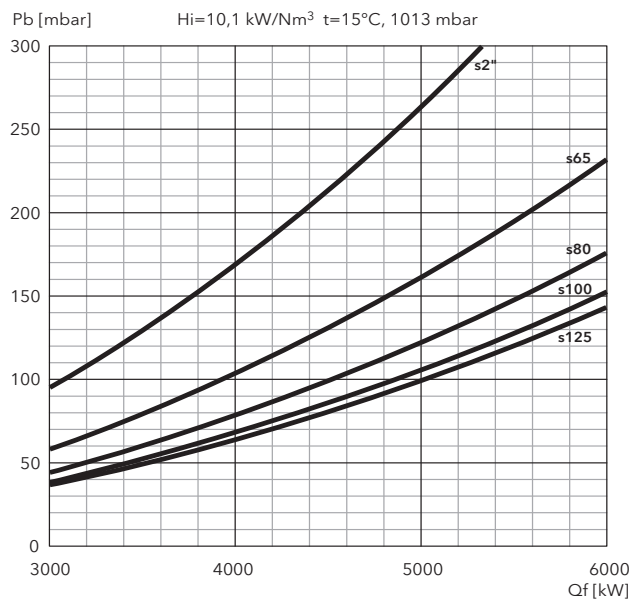

PRESSURE LOSSES (BURNER HEAD + GAS TRAIN)

FILTERS

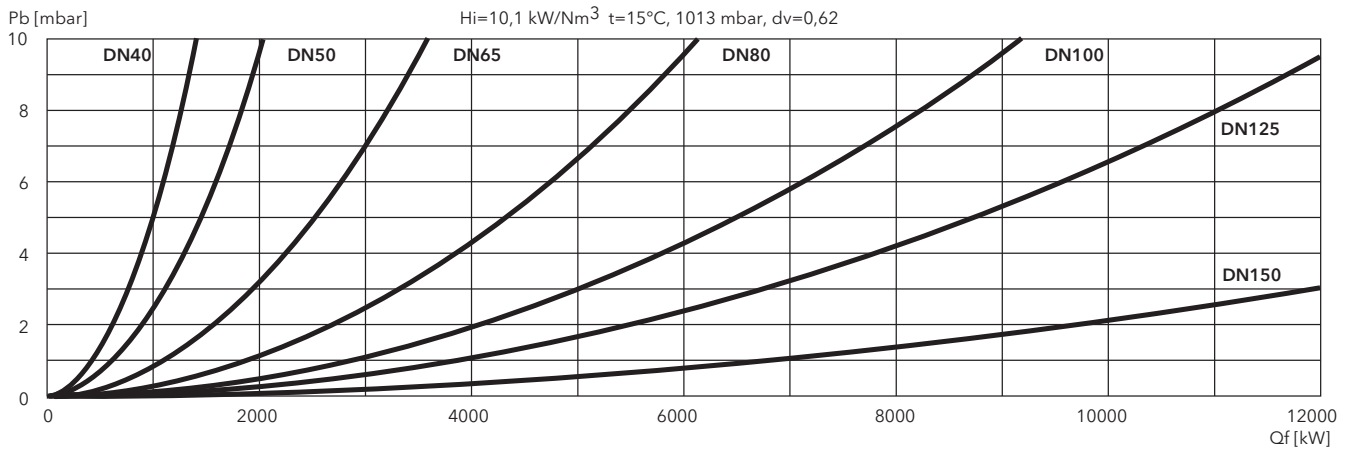

EKEVO 8 G-EU3, EKEVO 9 G-EU3

600 ... 10500 kW
2 stage progressive/modulating electronic (Low NOx class 3)

- **Fuels:** natural gas, low calorific value 6,99 ... 11,39 kWh/m³;
LPG, low calorific value 25,89 kWh/m³
- **Emission class:** Low NOx class 3 (<80 mg/kWh) according to EN676
- **Modulating ratio:** 1:10
- **Electrical power supply:** single-phase 230 V - 50 Hz
- **Protection level:** IP 41

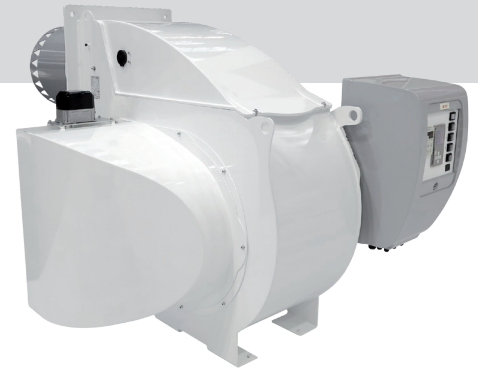

TECHNICAL DATA

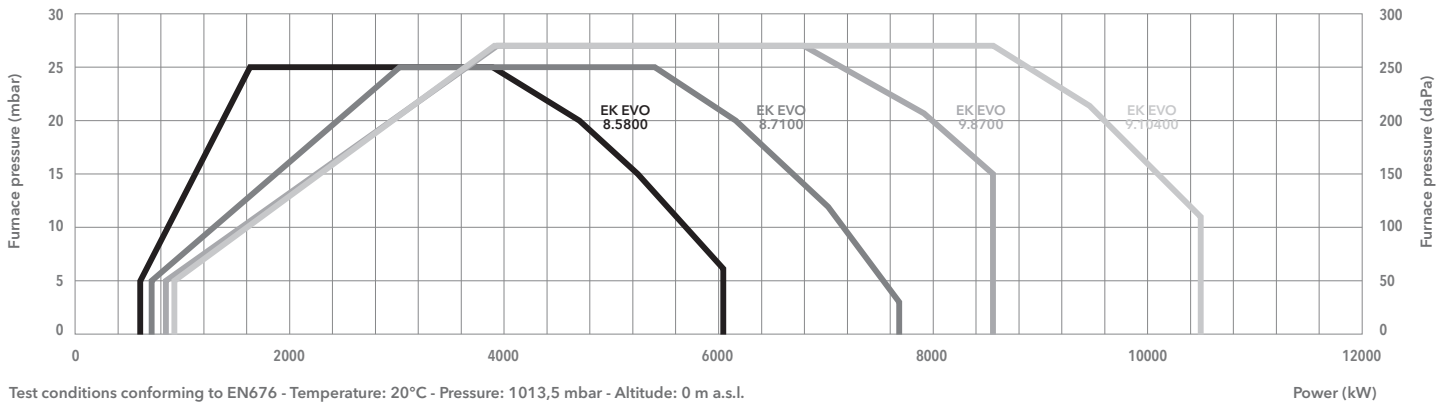

Test conditions conforming to EN676 - Temperature: 20°C - Pressure: 1013,5 mbar - Altitude: 0 m a.s.l.

	EKEVO 8.5800 G-EU3	EKEVO 8.7100 G-EU3	EKEVO 9.8700 G-EU3	EKEVO 9.10400 G-EU3
Operating range	600 - 6070 kW	700 - 7700 kW	850 - 8530 kW	910 - 10500 kW
Gas pressure	70 - 500 mbar (70 - 360 mbar for d457)			
Control box / flame detector	BT300 / Ionisation		BT300 / Ionisation	
Auxiliary voltage	1NPE AC 230 V - 50 Hz TN-S			
Power supply	3PE AC 400 V - 50 Hz			
Fan motor	50 Hz - 11 kW	50 Hz - 15 kW	50 Hz - 18,5 kW	50 Hz - 22 kW
Acoustic level	<80,2 dB(A)	<82,3 dB(A)	<85,4 dB(A)	<86,1 dB(A)
CE certificate	00850CL0215			
Burner codes (body + head)	KN	3753969	3753970	3753971
	KM	3753978	3753979	3753980
	KL	3753986	3753987	3753988

GAS TRAINS

DUNGS

Model	Code
GT-d457-2" (*)	3750515
GT-d458-65	3750516
GT-d459-80	3750517
GT-d460-100	3750518

SIEMENS

Model	Code
GT-s457-2"	3750537
GT-s458-65	3750538
GT-s459-80	3750539
GT-s460-100	3750540
GT-s461-125	3750541

FILTERS

Model	Code
FG-Rp2"	3750544
FG-DN65	3750545
FG-DN80	3750546
FG-DN100	3750547
FG-DN125	3750548

*: integrated filter

i **Pressure drops graphs:** see following pages
Dimensions of gas trains and gas filters: see pag. 201

DIMENSIONS (mm)

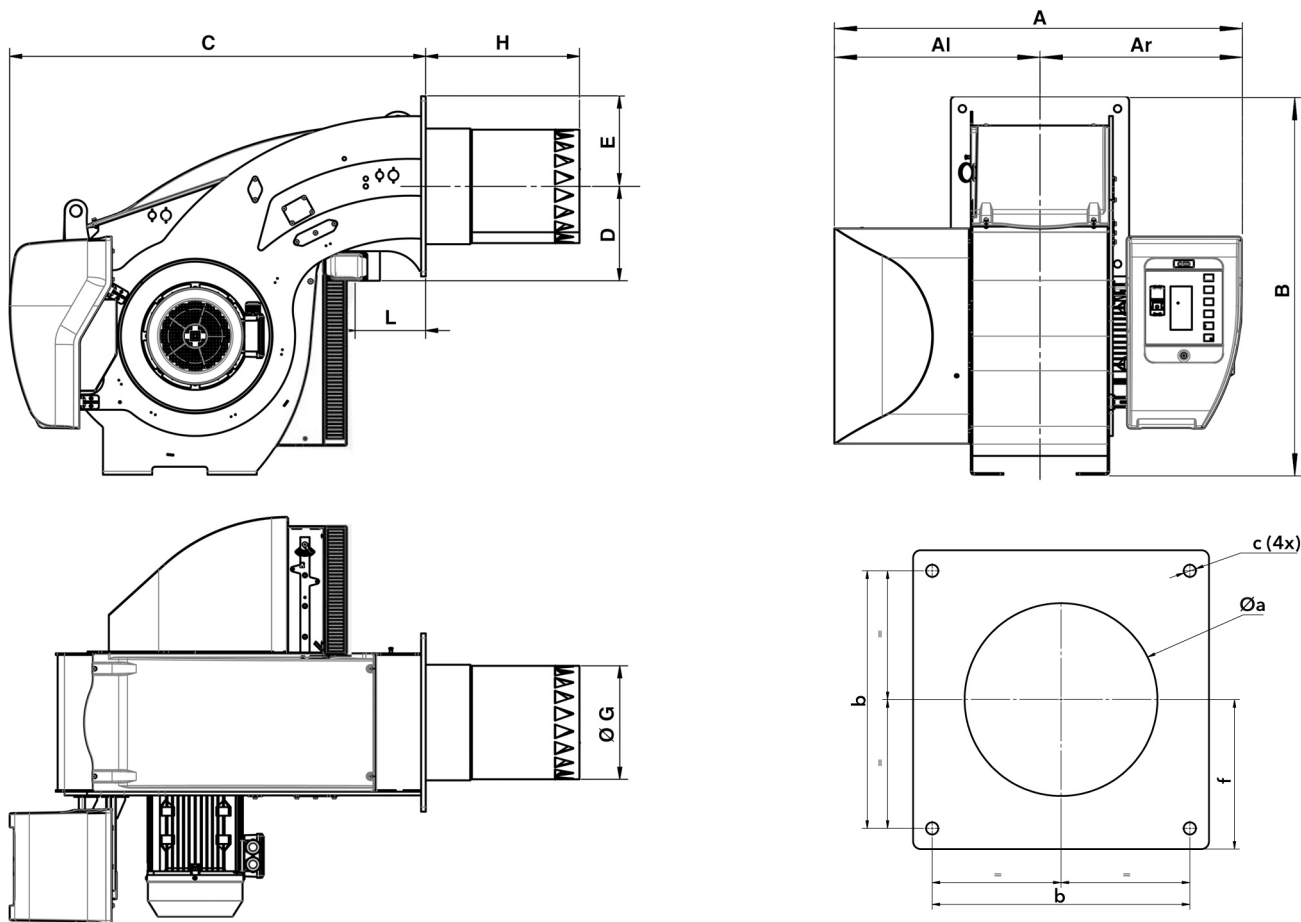

Model	A	AI	Ar	B	C	D	E	ØG	H			L	Øa	b	c	f
									KN	KM	KL					
EKEVO 8	1336	670	666	1226	1354	307	288	376	500	640	780	230	390-410	505	M20	293
EKEVO 9	1400	670	730	1291	1325	332	293	439	550	700	850	230	460-480	505	M20	293

PACKAGING

- The burner is delivered in 2 packages containing:
- burner body with mounted combustion head, boiler fixing accessories and technical documentation;
 - gas train and filter.

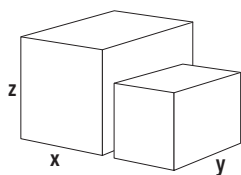

Models		Dimensions (mm)			Gross weight (kg)
		X	Y	Z	
EK EVO 8.5800 G-EU3	KN	2300	1500	1396	481
	KM	2300	1500	1396	487
	KL	2300	1500	1396	498
EK EVO 8.7100 G-EU3	KN	2300	1500	1396	497
	KM	2300	1500	1396	503
	KL	2300	1500	1396	514
EK EVO 9.8700 G-EU3	KN	2300	1500	1461	524
	KM	2300	1500	1461	532
	KL	2300	1500	1461	539
EK EVO 9.10400 G-EU3	KN	2300	1500	1461	546
	KM	2300	1500	1461	553
	KL	2300	1500	1461	565

PRESSURE LOSSES (BURNER HEAD + GAS TRAIN)

EK EVO 8.5800 G-EU3

DUNGS

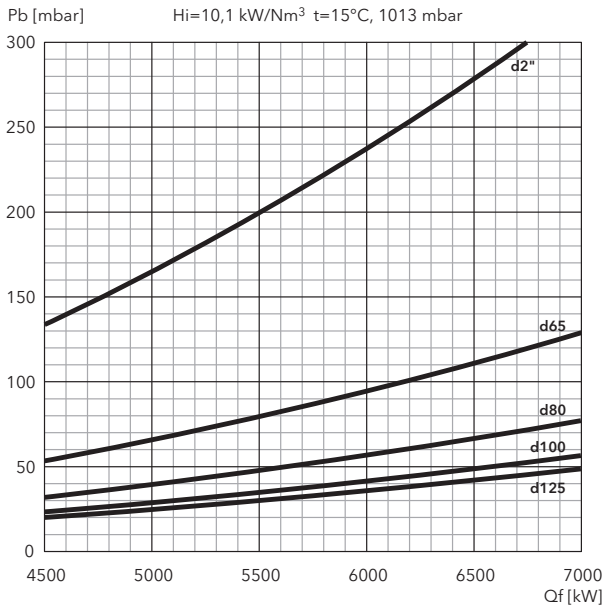

SIEMENS

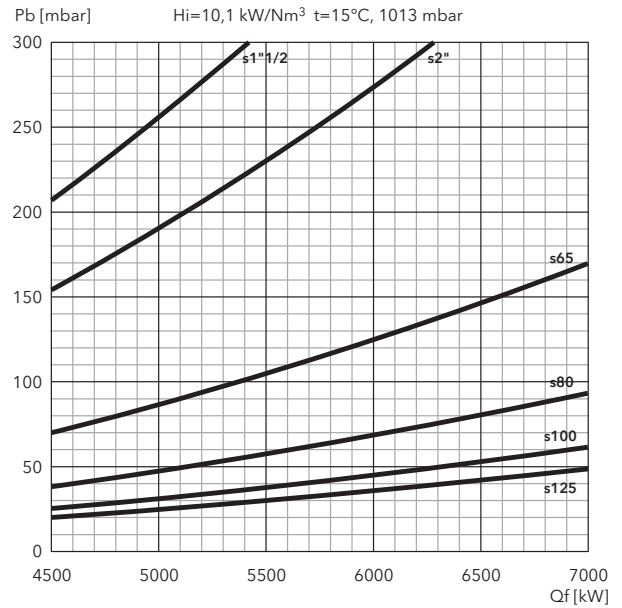

EK EVO 8.7100 G-EU3

DUNGS

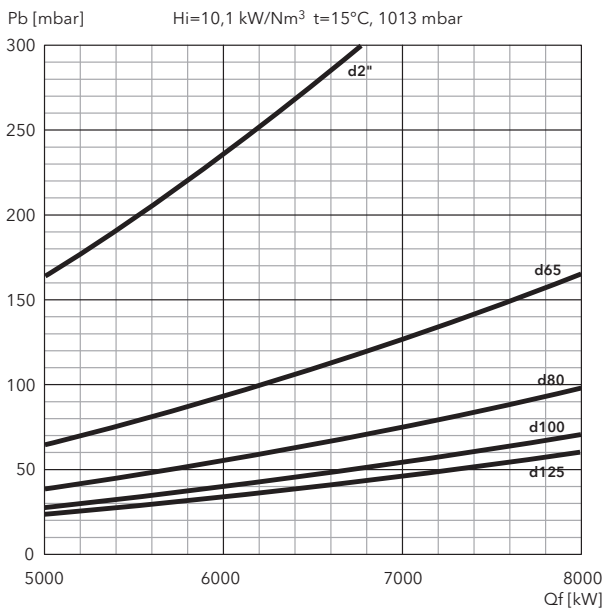

SIEMENS

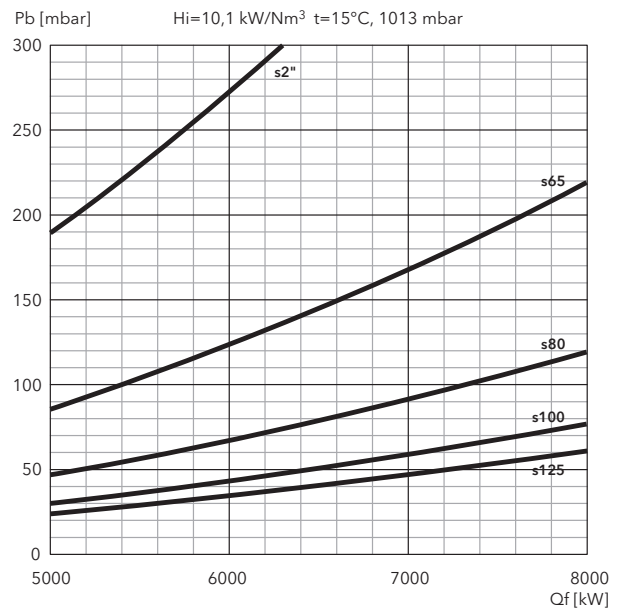

FILTERS

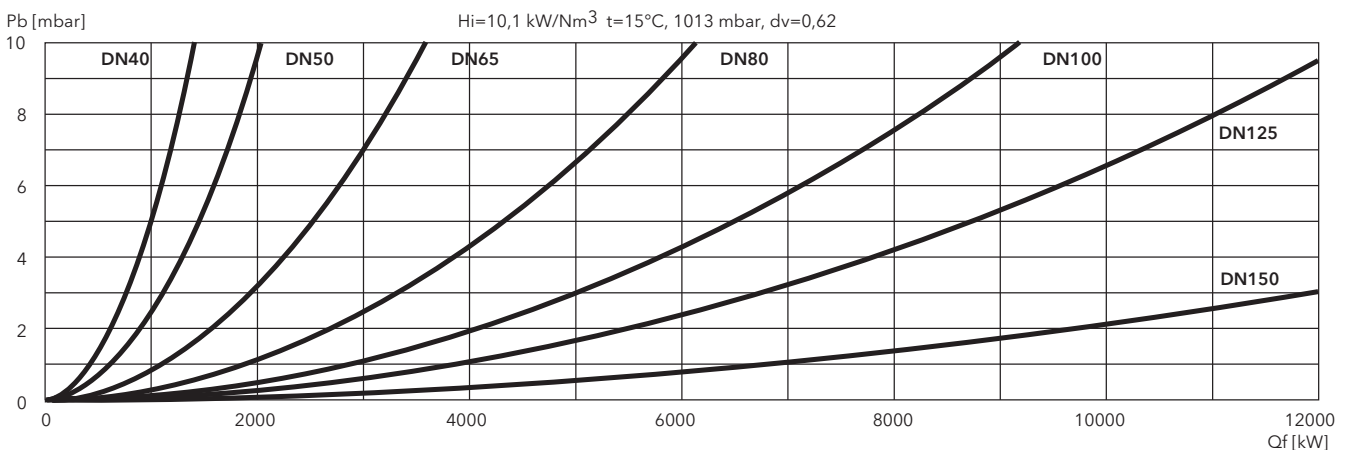

PRESSURE LOSSES (BURNER HEAD + GAS TRAIN)

EK EVO 9.8700 G-EU3

DUNGS

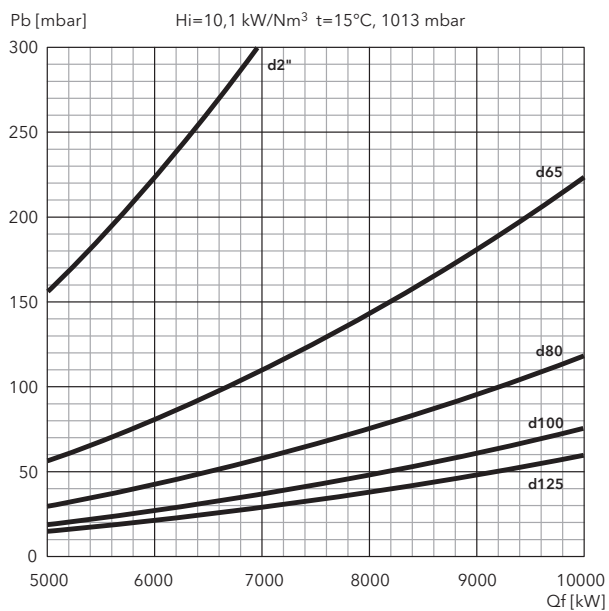

SIEMENS

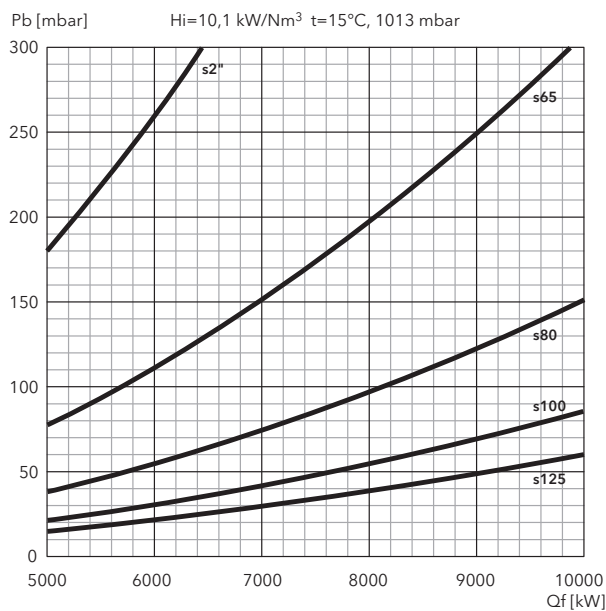

EK EVO 9.10400 G-EU3

DUNGS

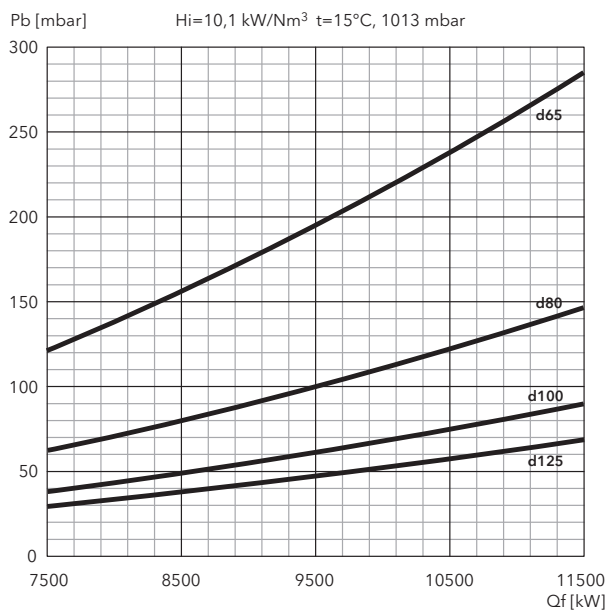

SIEMENS

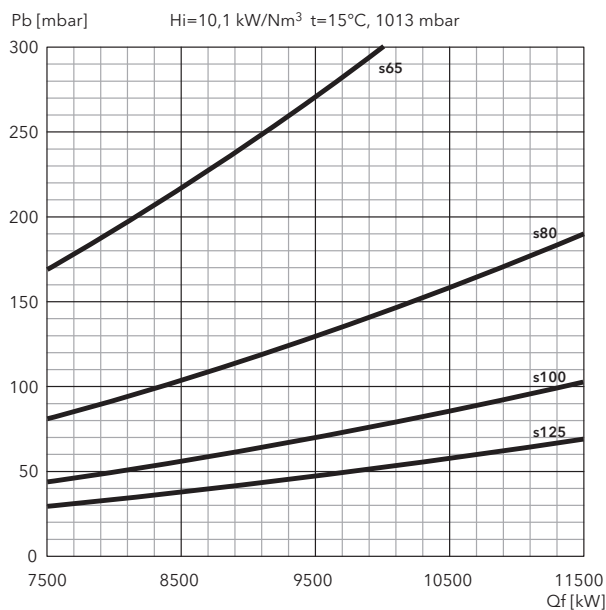

FILTERS

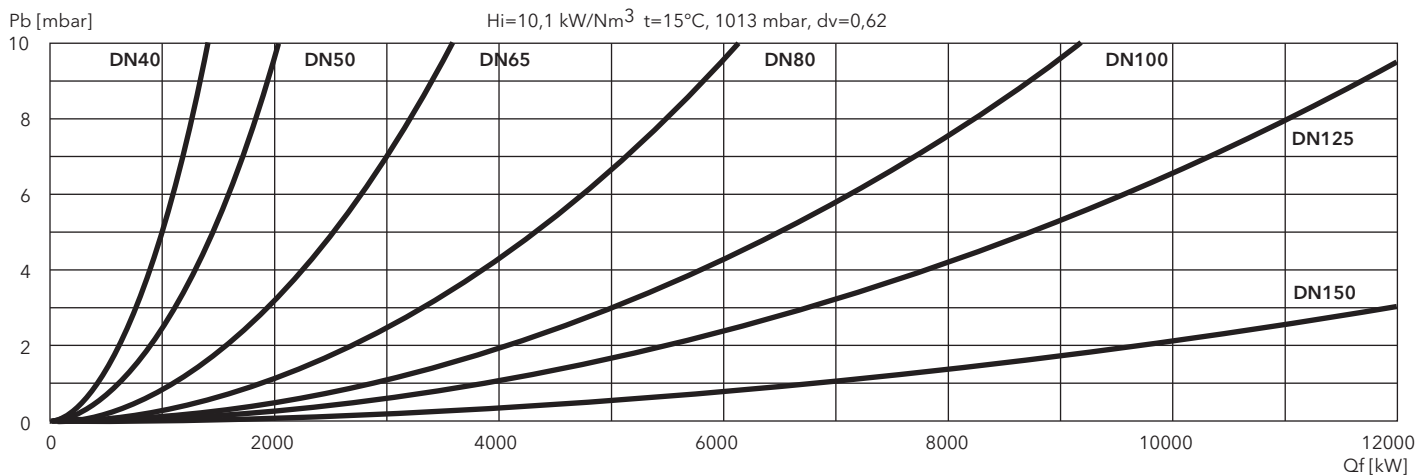

EKEVO 9.13000 G-EU2

2500 ... 13500 kW

2 stage progressive/modulating electronic (Low NOx class 3)

- **Fuels:** natural gas, low calorific value 6,99 ... 11,39 kWh/m³;
LPG, low calorific value 25,89 kWh/m³
- **Emission class:** Low NOx class 3 (<80 mg/kWh) according to EN676
- **Electrical power supply:** single-phase 230 V - 50 Hz
- **Protection level:** IP 41

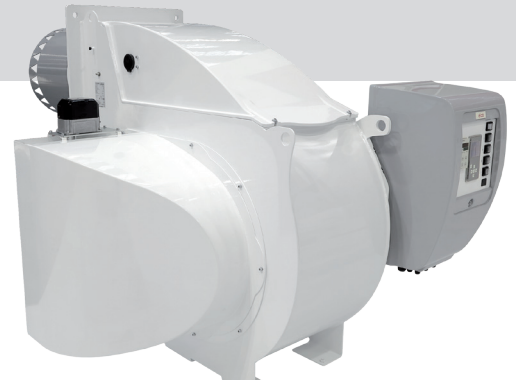

TECHNICAL DATA

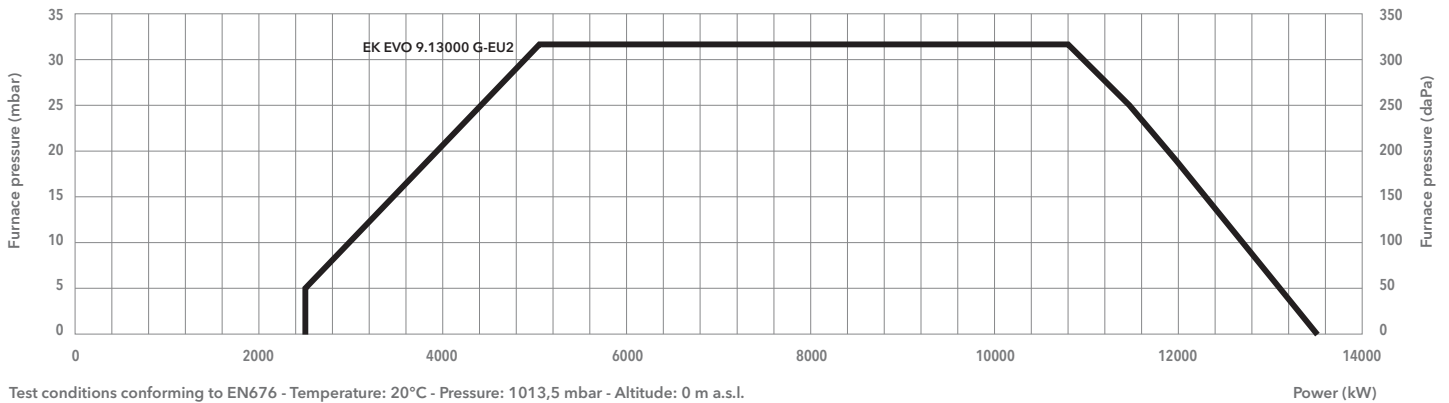

Test conditions conforming to EN676 - Temperature: 20°C - Pressure: 1013,5 mbar - Altitude: 0 m a.s.l.

EKEVO 9.13000 G-EU2	
Operating range	2500 - 13500 kW
Gas pressure	80 - 500 mbar (80 - 360 mbar for d457)
Control box / flame detector	BT300 / Ionisation
Auxiliary voltage	1NPE AC 230 V - 50/60 Hz
Power supply	3PE AC 400 V - 50 Hz
Fan motor	50 Hz - 37 kW
Emission grade	Class 3 (<80 mg/kWh)
Acoustic level	<86,1 dB(A)
CE certificate	00850CL0215

GAS TRAINS

DUNGS

Model	Code
GT-d459-80	3750517
GT-d460-100	3750518
GT-d4.....-125	on request

SIEMENS

Model	Code
GT-s459-80	3750539
GT-s460-100	3750540
GT-s461-125	3750541
GT-s4.....-150	on request

FILTERS

Model	Code
FG-DN80	3750546
FG-DN100	3750547
FG-DN125	3750548
FG-DN150	on request

 **Pressure drops graphs:** see following pages
Dimensions of gas trains and gas filters: see pag. 201

DIMENSIONS (mm)

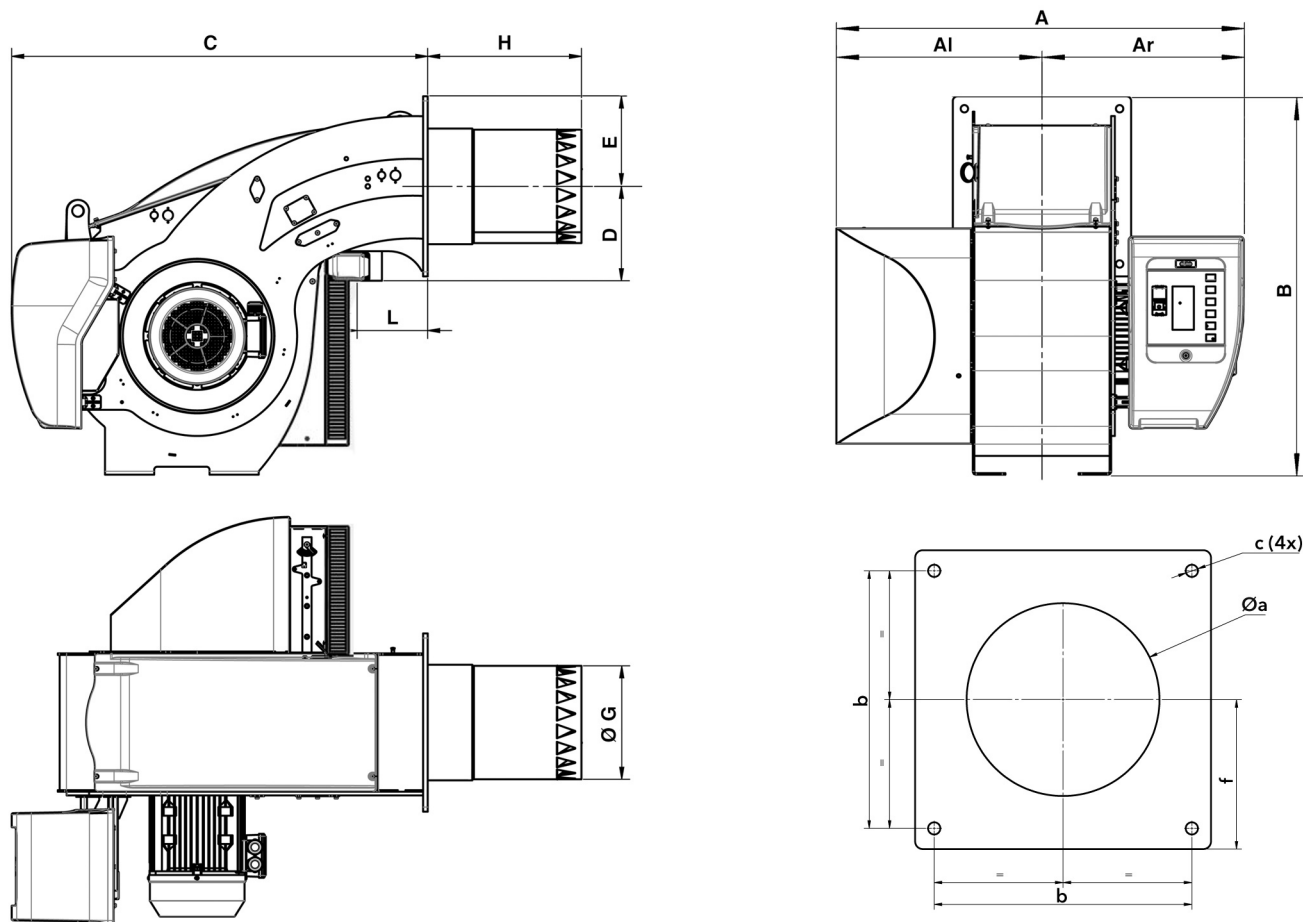

A	Al	Ar	B	C	D	E	ØG	H			L	Øa	b	c	f
								KN	KM	KL					
1400	670	730	1291	1325	332	293	439	550	700	850	230	460-480	505	M20	293

PACKAGING

- The burner is delivered in 2 packages containing:
- burner body with mounted combustion head, boiler fixing accessories and technical documentation;
 - gas train and filter.

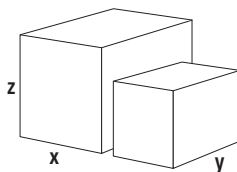

	Dimensions (mm)			Gross weight (kg)
	X	Y	Z	
KN	2300	1500	1461	546
KM	2300	1500	1461	553
KL	2300	1500	1461	565

PRESSURE LOSSES (BURNER HEAD + GAS TRAIN)

EK EVO 9.13000 G-EU2

DUNGS

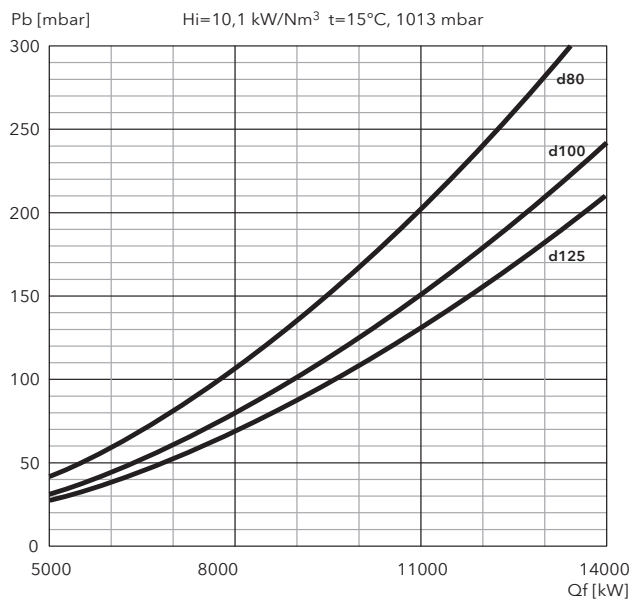

SIEMENS

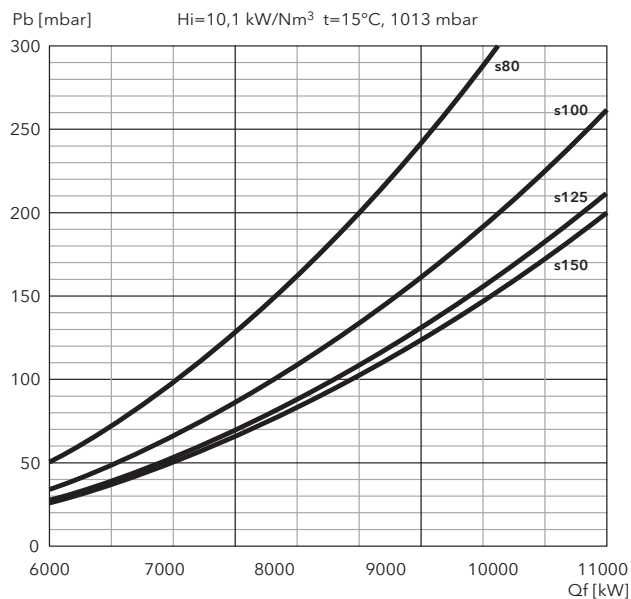

PRESSURE LOSSES (BURNER HEAD + GAS TRAIN)

FILTERS

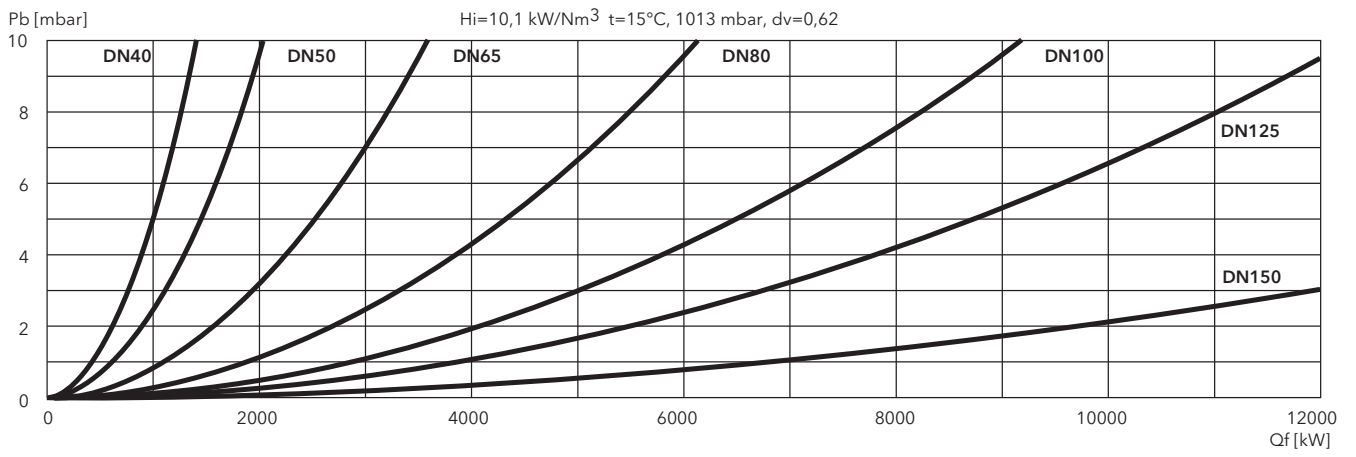

EKEVO 6 GL-EZ3, EKEVO 7 GL-EZ3

600 ... 4740 kW

2 stage progressive/modulating electronic in gas / 3 stages in light oil

- **Fuels:** natural gas, low calorific value 6,99 ... 11,39 kWh/m³;
light oil, viscosity 6 mm²/s at 20°C, low calorific value 11,86 kWh/kg
- **Emission class:** Low NO_x class 2 (<120 mg/kWh) according to EN676 in gas
Low NO_x class 2 (<185 mg/kWh) according to EN267 in light oil
- **Electrical power supply:** single-phase 230 V - 50 Hz
- **Protection level:** IP 41



TECHNICAL DATA

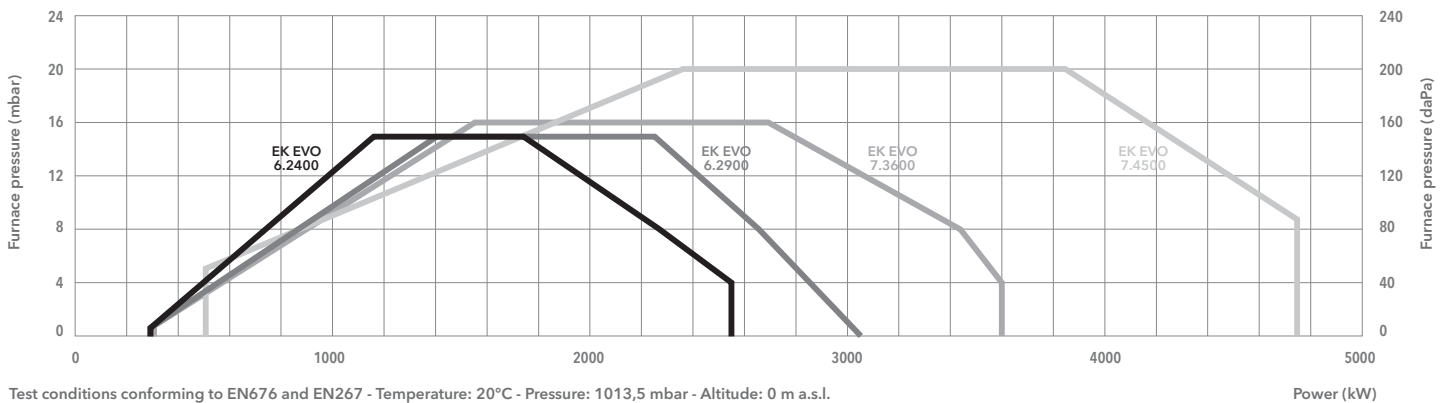

Test conditions conforming to EN676 and EN267 - Temperature: 20°C - Pressure: 1013,5 mbar - Altitude: 0 m a.s.l.

Power (kW)

	EK EVO 6.2400 GL-EZ3	EK EVO 6.2900 GL-EZ3	EK EVO 7.3600 GL-EZ3	EK EVO 7.4500 GL-EZ3
Operating range gas	290 - 2550 kW	290 - 3050 kW	300 - 3600 kW	510 - 4740 kW
Operating range oil	730 - 2470 kW	730 - 2790 kW	1090 - 3600 kW	1300 - 4740 kW
Gas pressure	50 - 500 mbar (50 - 360 mbar for d452 and d453)			
Control box / flame detector	BT300 / QRA2	BT300 / QRA2	BT300 / QRA2	BT300 / QRA2
Auxiliary voltage	1NPE AC 230 V - 50 Hz TN-S	1NPE AC 230 V - 50 Hz TN-S	1NPE AC 230 V - 50 Hz TN-S	1NPE AC 230 V - 50 Hz TN-S
Power supply	3PE AC 400 V - 50 Hz	3PE AC 400 V - 50 Hz	3PE AC 400 V - 50 Hz	3PE AC 400 V - 50 Hz
Fan motor	50 Hz - 3 kW	50 Hz - 4 kW	50 Hz - 5,5 kW	50 Hz - 7,5 kW
Acoustic level	<75 dB(A)	<77 dB(A)	<81 dB(A)	<82,5 dB(A)
CE certificate	00850CL0215	00850CL0215	00850CL0215	00850CL0215
Burner codes (body + head)	KN	3754106	3754107	3754108
	KM	3754110	3754111	3754112
	KL	3754114	3754115	3754116

GAS TRAINS

DUNGS

Model	Code
GT-d452-1"1/2 (*)	3750510
GT-d453-2" (*)	3750511
GT-d454-65	3750512
GT-d455-80	3750513
GT-d456-100	3750514

SIEMENS

Model	Code
GT-s451-1"1/2	3750525
GT-s452-2"	3750526
GT-s453-65	3750527
GT-s454-80	3750528
GT-s455-100	3750529
GT-s456-125	3750530

FILTERS

Model	Code
FG-Rp1"1/2	3750543
FG-Rp2"	3750544
FG-DN65	3750545
FG-DN80	3750546
FG-DN100	3750547
FG-DN125	3750548

*: integrated filter

 **Pressure drops graphs:** see following pages
Dimensions of gas trains and gas filters: see pag. 200

DIMENSIONS (mm)

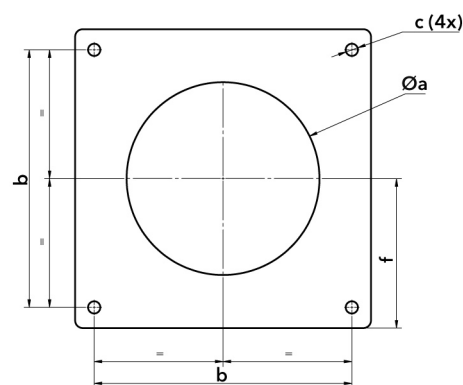
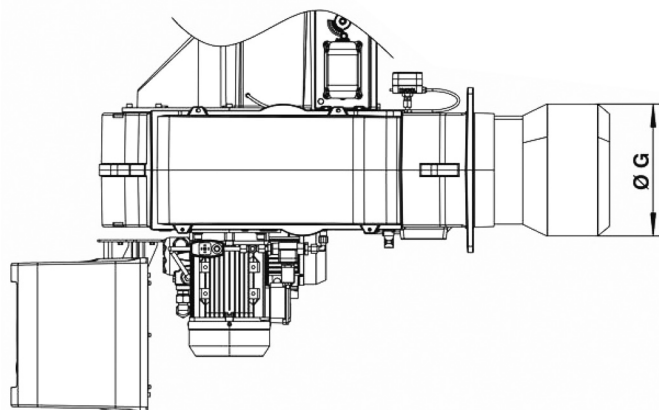
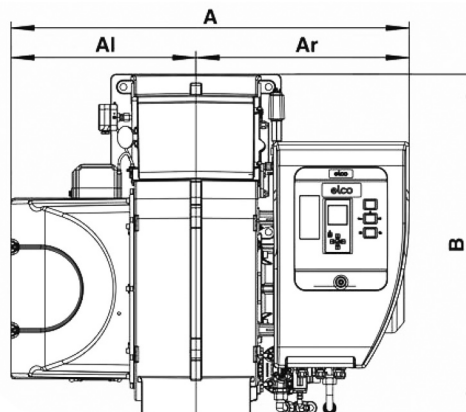
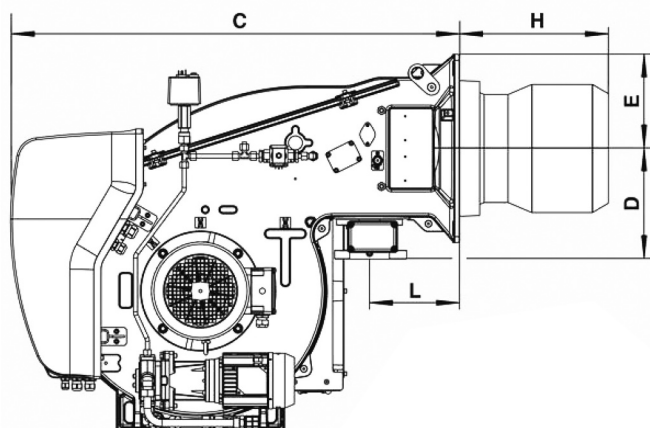

Model	A	Al	Ar	B	C	D	E	ØG	H			L	Øa	b	c	f
									KN	KM	KL					
EK EVO 6.2400	1035	479	556	812	1048	245	200	320	330	450	570	215	330-340	340	M16	200
EK EVO 6.2900	1035	479	556	812	1048	245	200	320	330	450	570	215	330-340	340	M16	200
EK EVO 7.3600	1093	506	587	941	1122	276	235	320	375	505	635	225	390-400	400	M16	235
EK EVO 7.4500	1093	506	587	941	1122	276	235	370	375	505	635	225	390-400	400	M16	235

PACKAGING

The burner is delivered in 2 packages containing:

- burner body with mounted combustion head, boiler fixing accessories and technical documentation;
- gas train and filter.

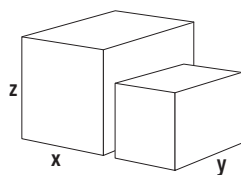

Models		Dimensions (mm)			Gross weight (kg)
		X	Y	Z	
EK EVO 6.2400 GL-EZ3	KN	2070	1420	990	188
	KM	2070	1420	990	190
	KL	2070	1420	990	192
EK EVO 6.2900 GL-EZ3	KN	2070	1420	990	194
	KM	2070	1420	990	196
	KL	2070	1420	990	198
EK EVO 7.3600 GL-EZ3	KN	2070	1420	1130	237
	KM	2070	1420	1130	239
	KL	2070	1420	1130	241
EK EVO 7.4500 GL-EZ3	KN	2070	1420	1130	243
	KM	2070	1420	1130	245
	KL	2070	1420	1130	247

PRESSURE LOSSES (BURNER HEAD + GAS TRAIN)

EK EVO 6.2400 GL-EZ3

DUNGS

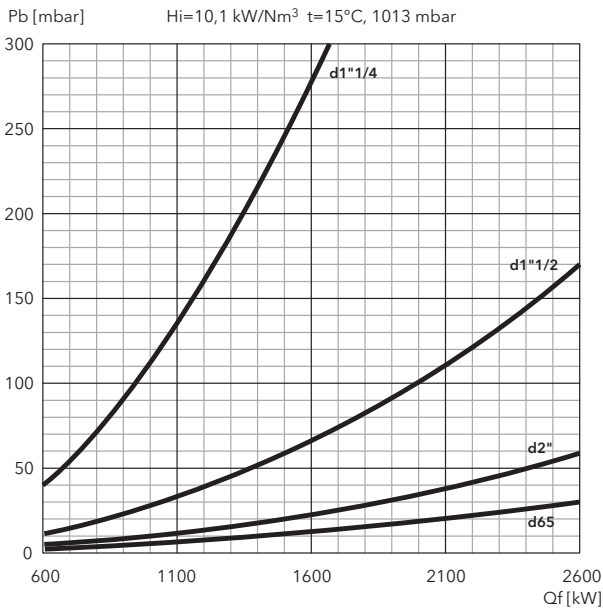

SIEMENS

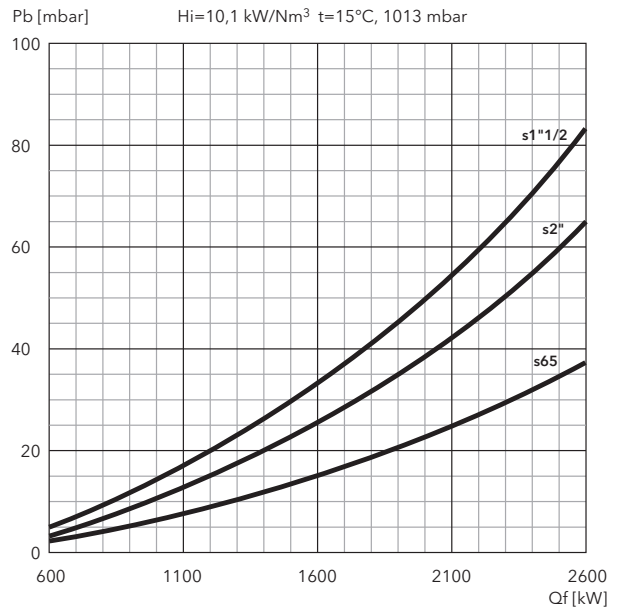

EK EVO 6.2900 GL-EZ3

DUNGS

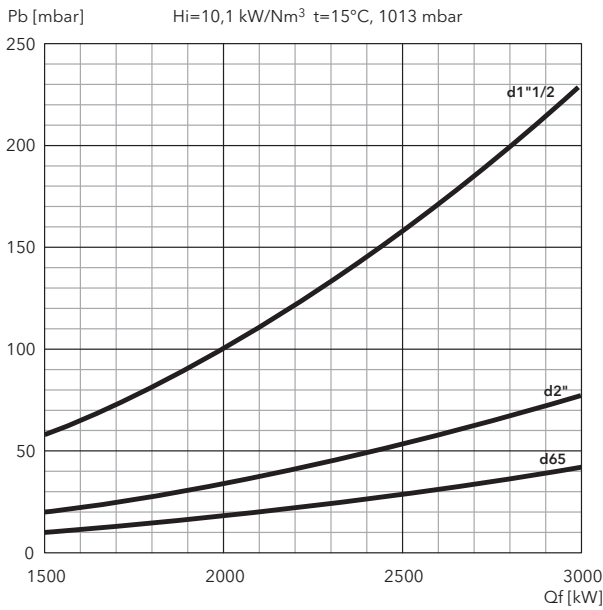

SIEMENS

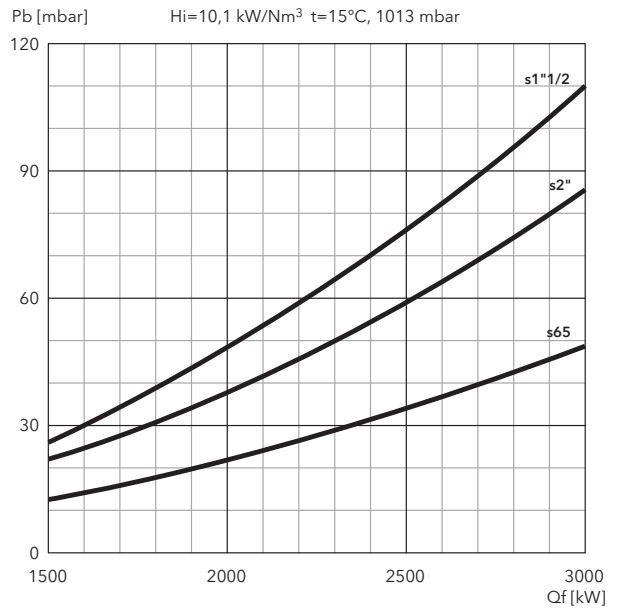

FILTERS

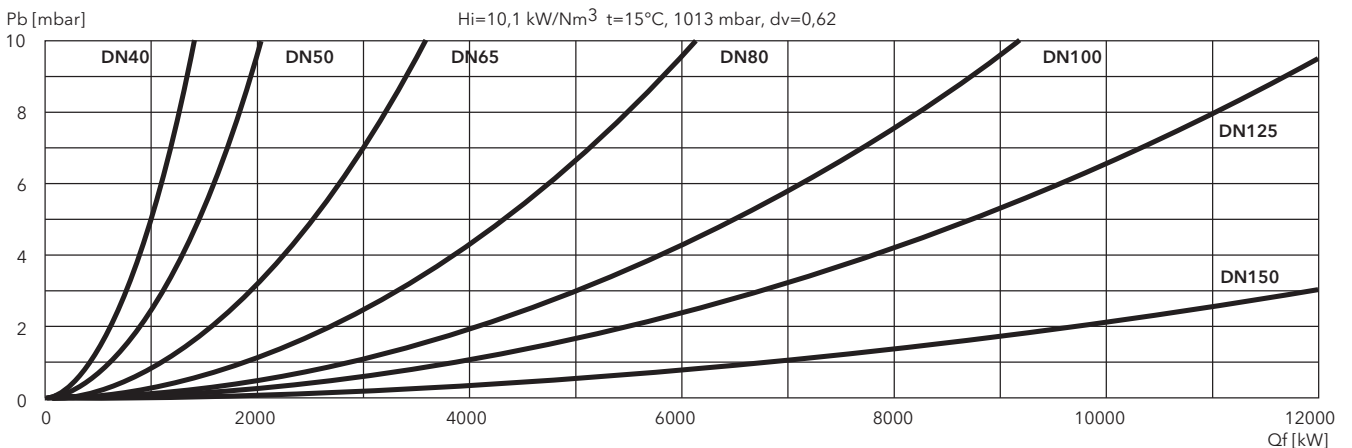

PRESSURE LOSSES (BURNER HEAD + GAS TRAIN)

EK EVO 7.3600 GL-EZ3

DUNGS

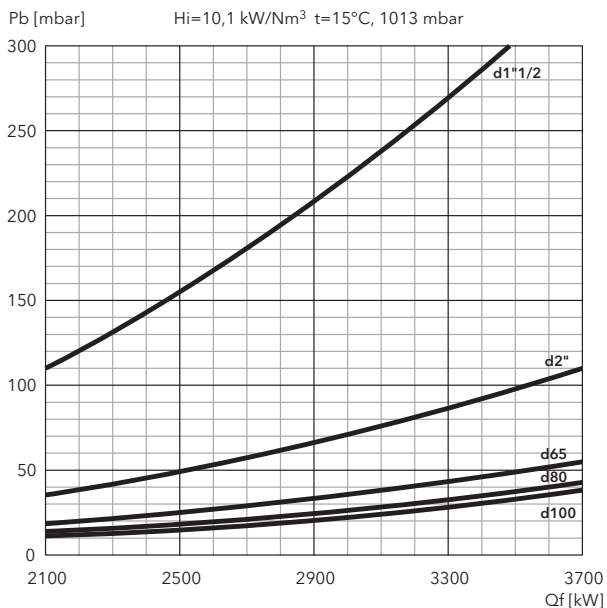

SIEMENS

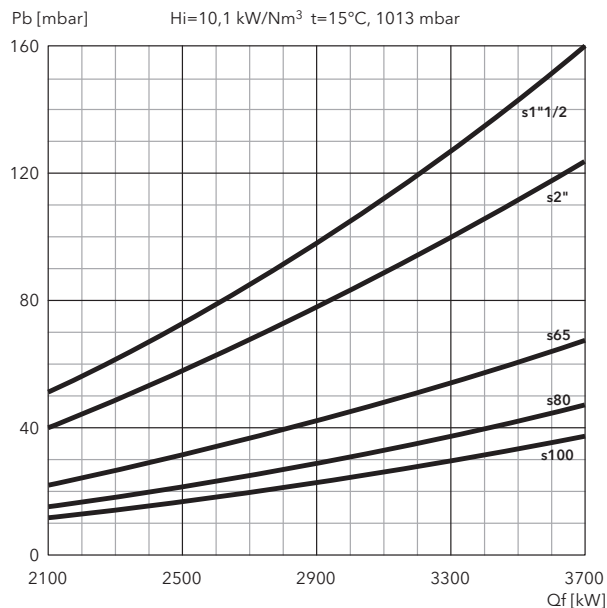

EK EVO 7.4500 GL-EZ3

DUNGS

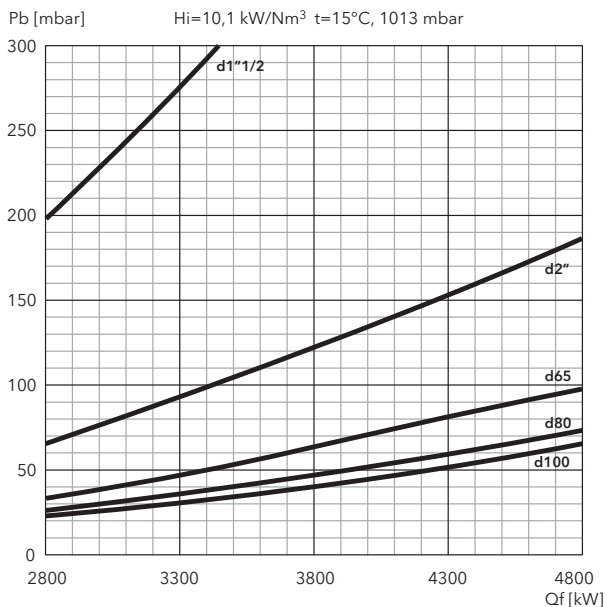

SIEMENS

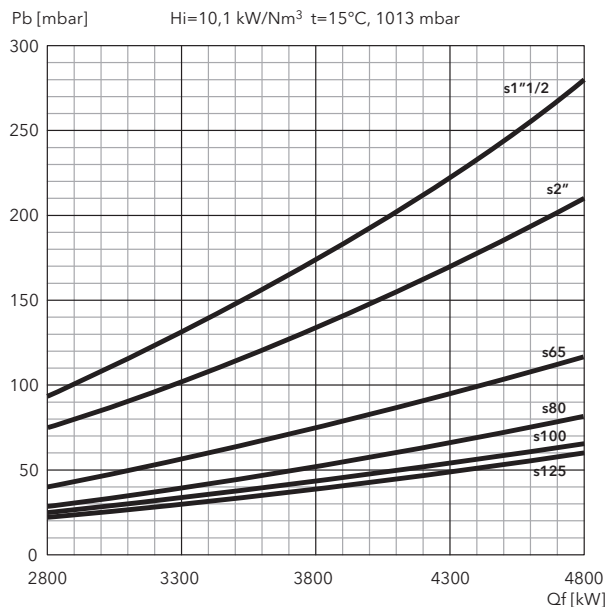

FILTERS

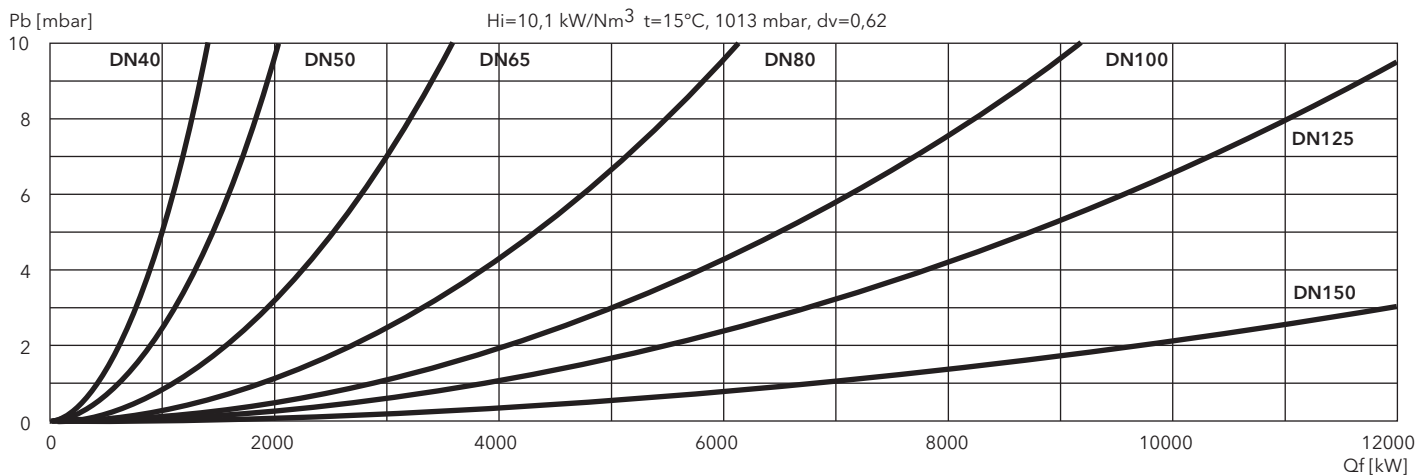

EKEVO 6 GL-E, EKEVO 7 GL-E

250 ... 4740 kW

2 stage progressive/modulating electronic in gas and in light oil

- **Fuels:** natural gas, low calorific value 6,99 ... 11,39 kWh/m³;
light oil, viscosity 6 mm²/s at 20°C, low calorific value 11,86 kWh/kg
- **Emission class:** Low NO_x class 2 (<120 mg/kWh) according to EN676 in gas
Low NO_x class 2 (<185 mg/kWh) according to EN267 in light oil
- **Electrical power supply:** single-phase 230 V - 50 Hz
- **Protection level:** IP 41

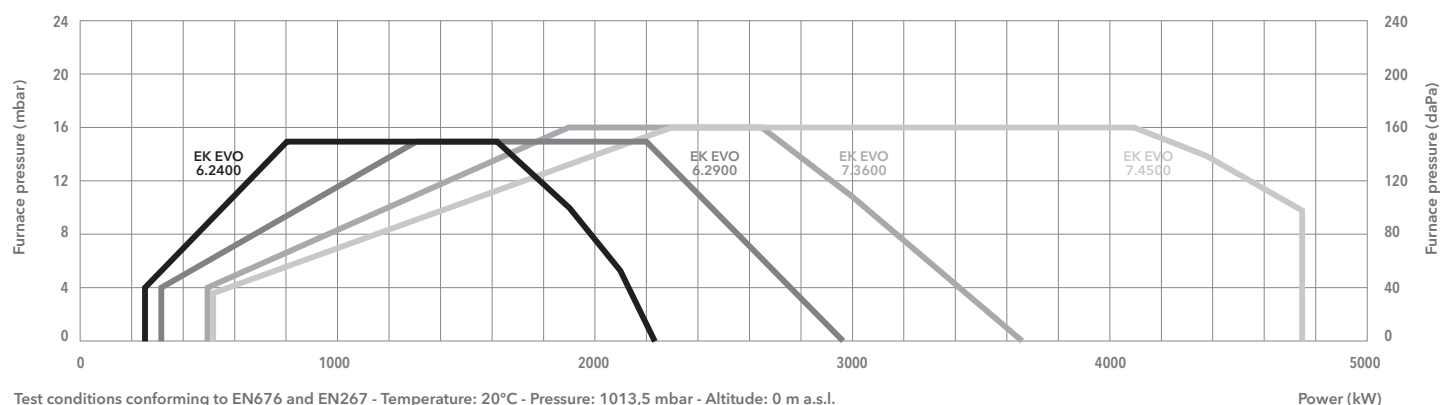
TECHNICAL DATA

Test conditions conforming to EN676 and EN267 - Temperature: 20°C - Pressure: 1013,5 mbar - Altitude: 0 m a.s.l.

Power (kW)

	EK EVO 6.2400 GL-E	EK EVO 6.2900 GL-E	EK EVO 7.3600 GL-E	EK EVO 7.4500 GL-E
Operating range gas	250 - 2230 kW	320 - 2970 kW	490 - 3650 kW	510 - 4740 kW
Operating range oil	510 - 2030 kW	650 - 2970 kW	900 - 3650 kW	1300 - 4740 kW
Gas pressure	50 - 500 mbar (50 - 360 mbar for d452 and d453)			
Control box / flame detector	BT300 / QRA2	BT300 / QRA2	BT300 / QRA2	BT300 / QRA2
Auxiliary voltage	1NPE AC 230 V - 50 Hz TN-S	1NPE AC 230 V - 50 Hz TN-S	1NPE AC 230 V - 50 Hz TN-S	1NPE AC 230 V - 50 Hz TN-S
Power supply	3PE AC 400 V - 50 Hz	3PE AC 400 V - 50 Hz	3PE AC 400 V - 50 Hz	3PE AC 400 V - 50 Hz
Fan motor	50 Hz - 3 kW	50 Hz - 4 kW	50 Hz - 5,5 kW	50 Hz - 7,5 kW
Acoustic level	<77 dB(A)	<77 dB(A)	<81 dB(A)	<82,5 dB(A)
CE certificate	00850CL0215	00850CL0215	00850CL0215	00850CL0215
Burner codes (body + head)	KN	3754276	3754277	3754278
	KM	3754280	3754281	3754282
	KL	3754284	3754285	3754286

GAS TRAINS
DUNGS

Model	Code
GT-d452-1"1/2 (*)	3750510
GT-d453-2" (*)	3750511
GT-d454-65	3750512
GT-d455-80	3750513
GT-d456-100	3750514

SIEMENS

Model	Code
GT-s451-1"1/2	3750525
GT-s452-2"	3750526
GT-s453-65	3750527
GT-s454-80	3750528
GT-s455-100	3750529
GT-s456-125	3750530

FILTERS

Model	Code
FG-Rp1"1/2	3750543
FG-Rp2"	3750544
FG-DN65	3750545
FG-DN80	3750546
FG-DN100	3750547
FG-DN125	3750548

*: integrated filter

 **Pressure drops graphs:** see following pages
Dimensions of gas trains and gas filters: see pag. 200



DIMENSIONS (mm)

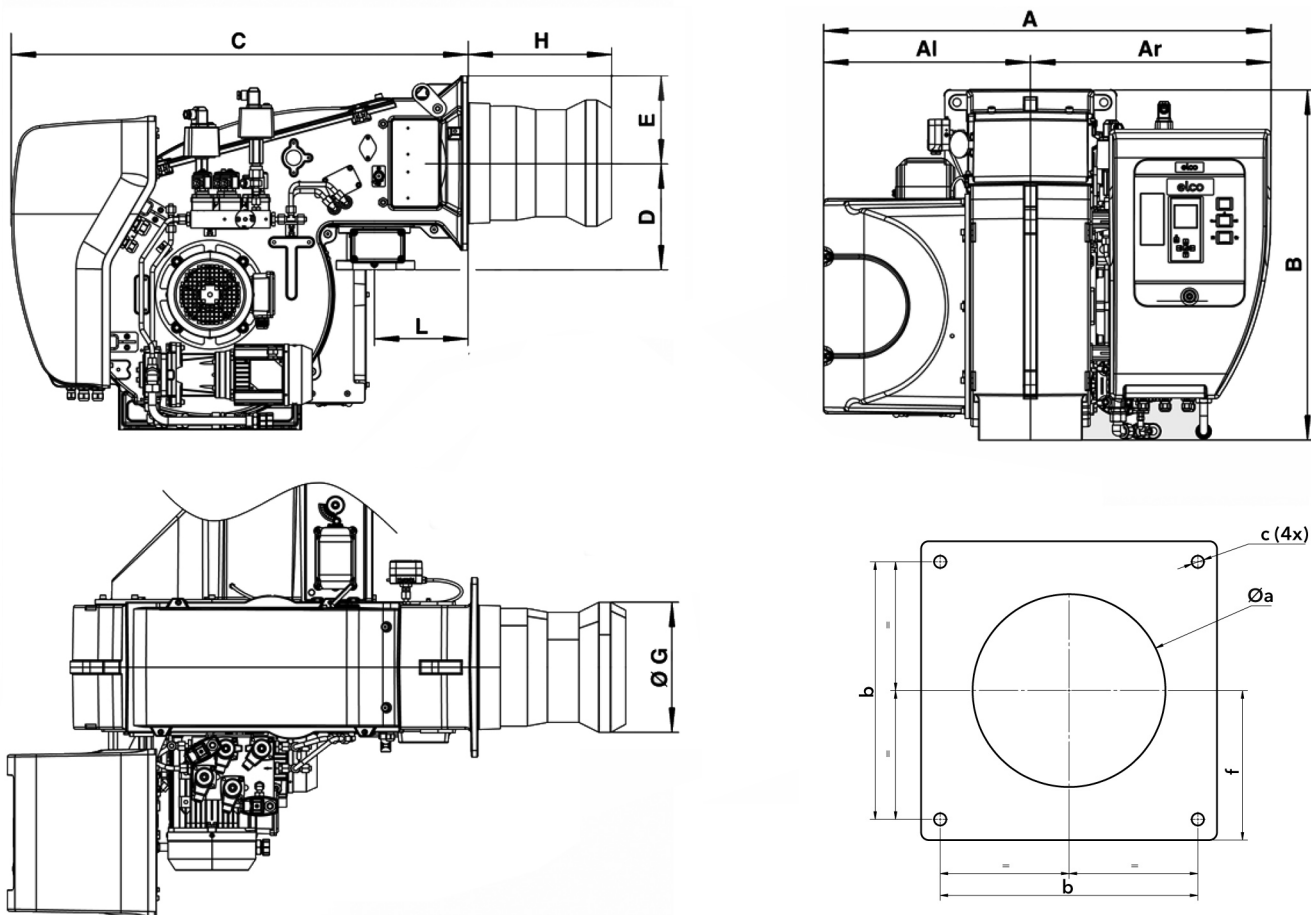

Model	A	Al	Ar	B	C	D	E	ØG	H			L	Øa	b	c	f
									KN	KM	KL					
EK EVO 6.2400	1035	479	556	812	1048	245	200	290	330	450	570	215	300-340	340	M16	200
EK EVO 6.2900	1035	479	556	812	1048	245	200	310	330	450	570	215	320-340	340	M16	200
EK EVO 7.3600	1093	506	587	941	1122	276	235	340	375	505	635	225	350-400	400	M16	235
EK EVO 7.4500	1093	506	587	941	1122	276	235	370	375	505	635	225	380-400	400	M16	235

PACKAGING

The burner is delivered in 2 packages containing:

- burner body with mounted combustion head, boiler fixing accessories and technical documentation;
- gas train and filter.

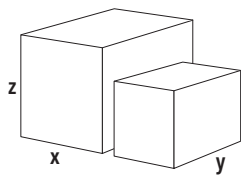

Models		Dimensions (mm)			Gross weight (kg)
		X	Y	Z	
EK EVO 6.2400 GL-E	KN	2070	1420	990	188
	KM	2070	1420	990	190
	KL	2070	1420	990	192
EK EVO 6.2900 GL-E	KN	2070	1420	990	194
	KM	2070	1420	990	196
	KL	2070	1420	990	198
EK EVO 7.3600 GL-E	KN	2070	1420	1130	237
	KM	2070	1420	1130	239
	KL	2070	1420	1130	241
EK EVO 7.4500 GL-E	KN	2070	1420	1130	243
	KM	2070	1420	1130	245
	KL	2070	1420	1130	247

PRESSURE LOSSES (BURNER HEAD + GAS TRAIN)

EK EVO 6.2400 GL-E

DUNGS

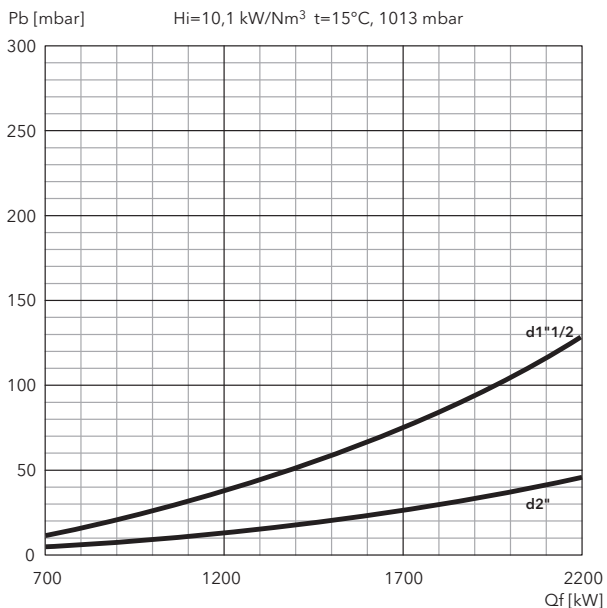

SIEMENS

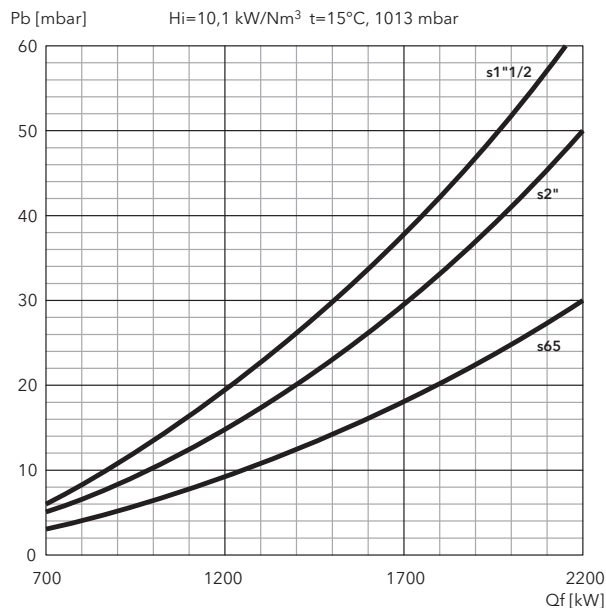

EK EVO 6.2900 GL-E

DUNGS

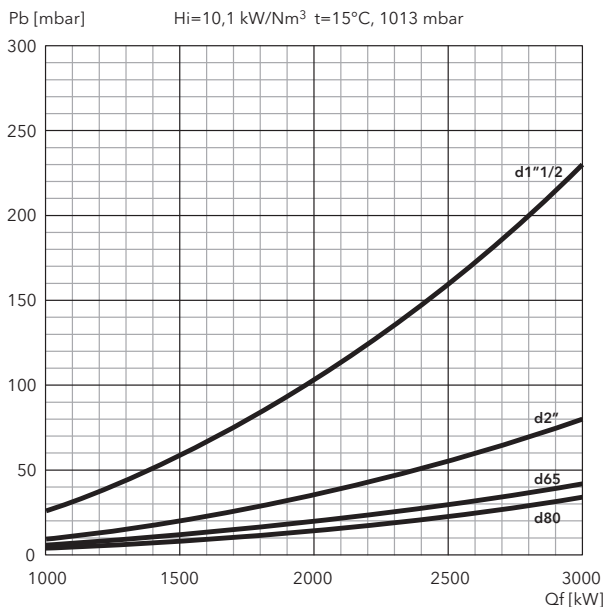

SIEMENS

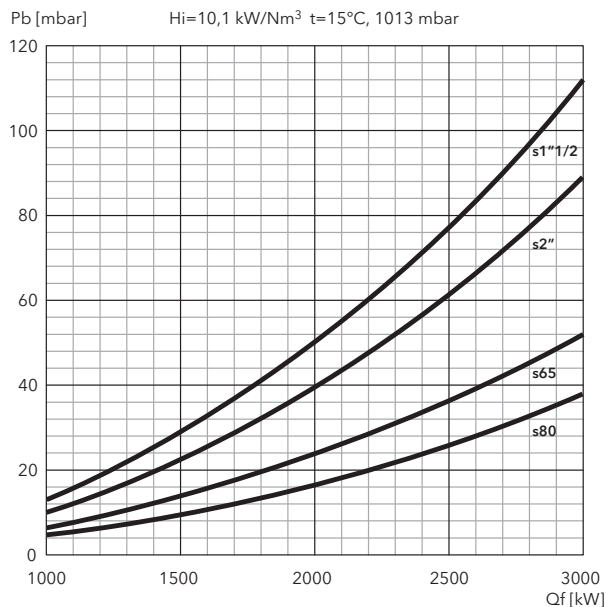

FILTERS

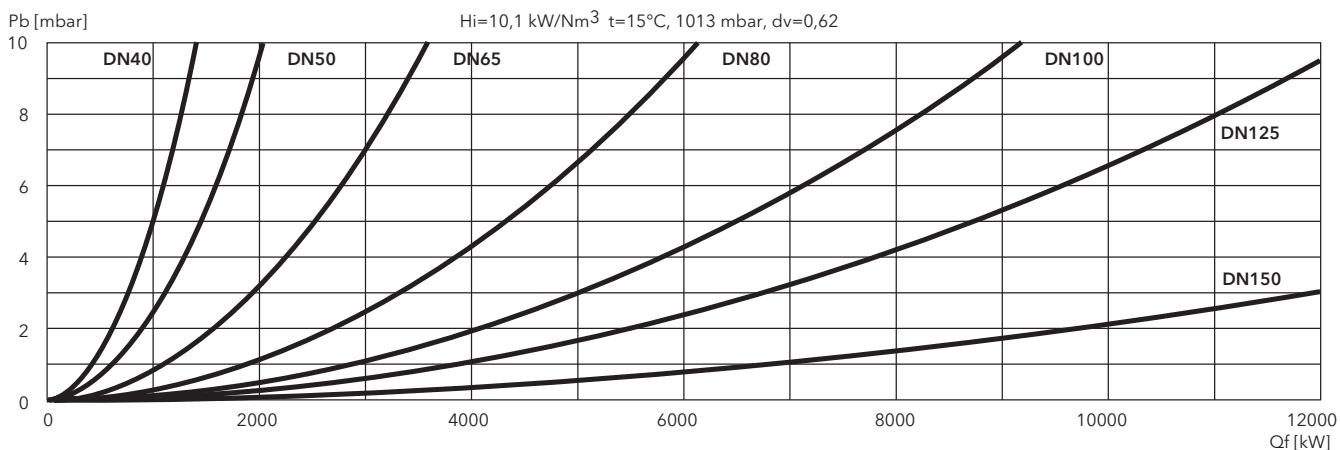

PRESSURE LOSSES (BURNER HEAD + GAS TRAIN)

EK EVO 7.3600 GL-E

DUNGS

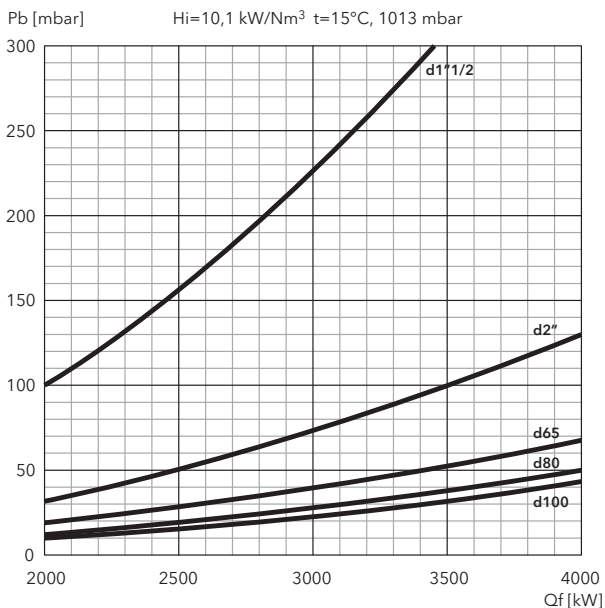

SIEMENS

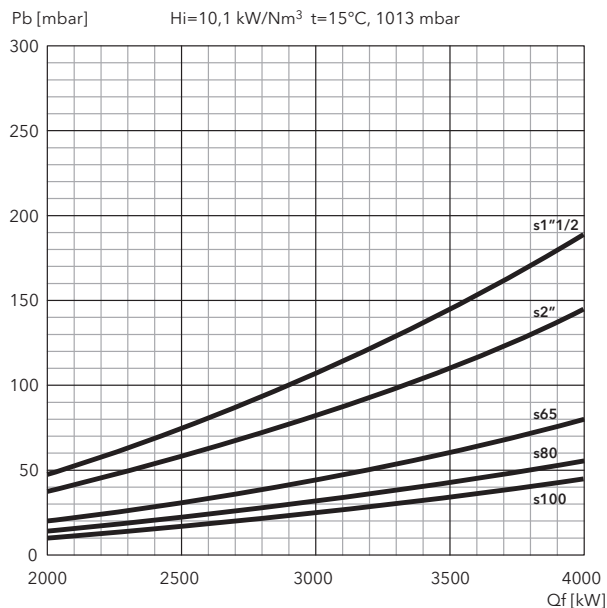

EK EVO 7.4500 GL-E

DUNGS

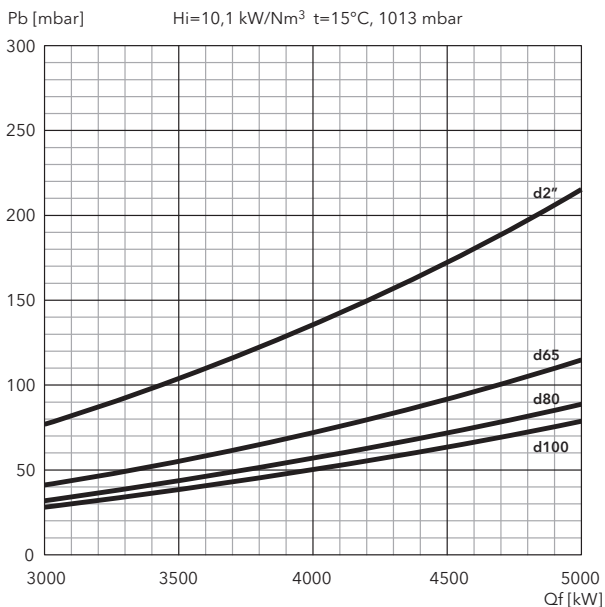

SIEMENS

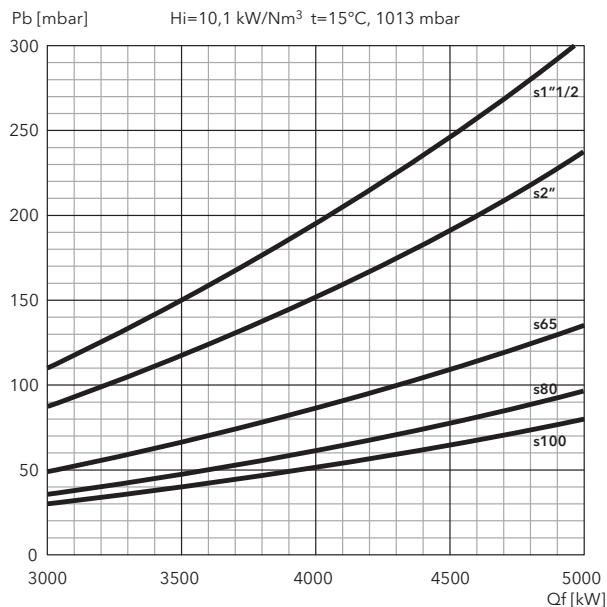

FILTERS

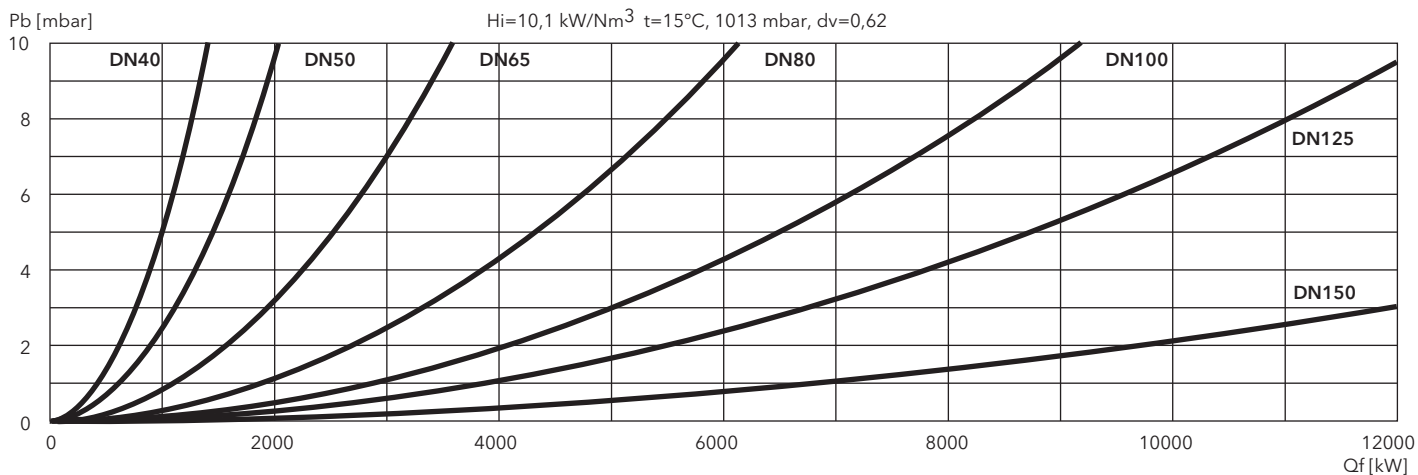

EKEVO 8 GL-E, EKEVO 9 GL-E

790 ... 10620 kW

2 stage progressive/modulating electronic in gas and in light oil

- **Fuels:** natural gas, low calorific value 6,99 ... 11,39 kWh/m³;
light oil, viscosity 6 mm²/s at 20°C, low calorific value 11,86 kWh/kg
- **Emission class:** Low NOx class 2 (<120 mg/kWh) according to EN676 in gas
Low NOx class 2 (<185 mg/kWh) according to EN267 in light oil
- **Electrical power supply:** single-phase 230 V - 50 Hz
- **Protection level:** IP 41

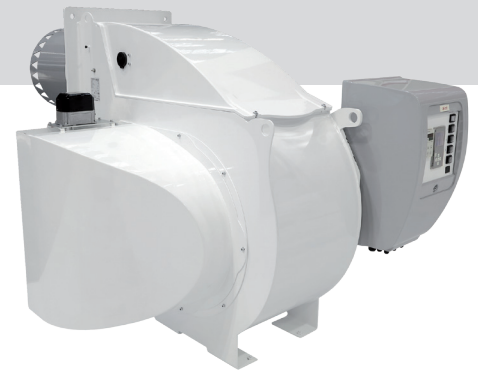

TECHNICAL DATA

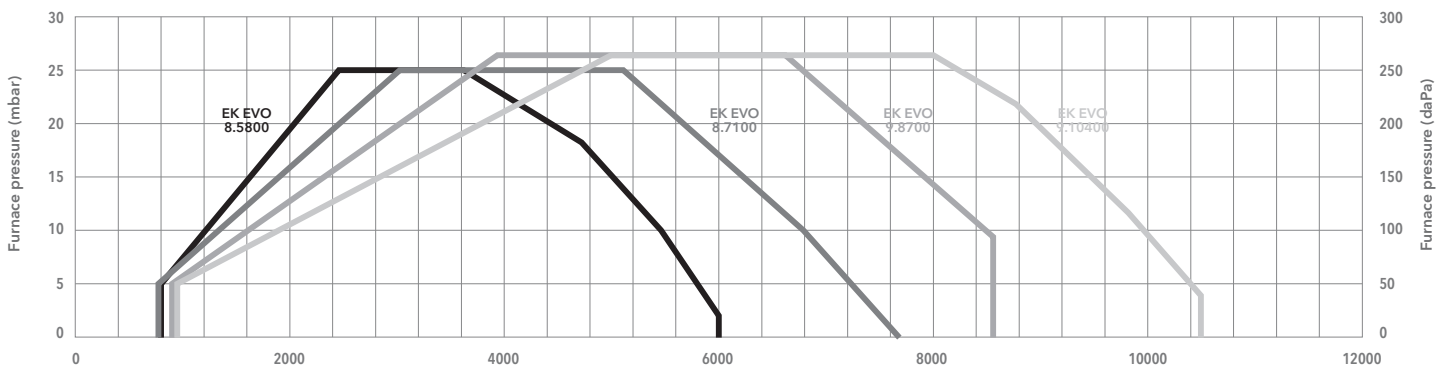

Test conditions conforming to EN676 and EN267 - Temperature: 20°C - Pressure: 1013,5 mbar - Altitude: 0 m a.s.l.

Power (kW)

	EK EVO 8.5800 GL-E	EK EVO 8.7100 GL-E	EK EVO 9.8700 GL-E	EK EVO 9.10400 GL-E
Operating range gas	800 - 6000 kW	790 - 7700 kW	880 - 8530 kW	910 - 10620 kW
Operating range oil	1210 - 6000 kW	1450 - 7700 kW	2400 - 8530 kW	2820 - 10620 kW
Gas pressure	100 - 500 mbar (100 - 360 mbar for d457)			
Control box / flame detector	BT300 / QRA2	BT300 / QRA2	BT300 / QRA2	BT300 / QRA2
Auxiliary voltage	1NPE AC 230 V - 50 Hz TN-S	1NPE AC 230 V - 50 Hz TN-S	1NPE AC 230 V - 50 Hz TN-S	1NPE AC 230 V - 50 Hz TN-S
Power supply	3PE AC 400 V - 50 Hz	3PE AC 400 V - 50 Hz	3PE AC 400 V - 50 Hz	3PE AC 400 V - 50 Hz
Fan motor	50 Hz - 11 kW	50 Hz - 15 kW	50 Hz - 18,5 kW	50 Hz - 22 kW
Acoustic level	<80,5 dB(A)	<82,6 dB(A)	<85,5 dB(A)	<86,2 dB(A)
CE certificate	00850CL0215	00850CL0215	00850CL0215	00850CL0215
Burner codes (body + head)	KN	3754601	3754602	3754603
	KM	3754605	3754606	3754607
	KL	3754609	3754610	3754611

GAS TRAINS

DUNGS

Model	Code
GT-d457-2" (*)	3750515
GT-d458-65	3750516
GT-d459-80	3750517
GT-d460-100	3750518

SIEMENS

Model	Code
GT-s457-2"	3750537
GT-s458-65	3750538
GT-s459-80	3750539
GT-s460-100	3750540
GT-s461-125	3750541

FILTERS

Model	Code
FG-Rp2"	3750544
FG-DN65	3750545
FG-DN80	3750546
FG-DN100	3750547
FG-DN125	3750548

*: integrated filter

i Pressure drops graphs: see following pages
Dimensions of gas trains and gas filters: see pag. 201



DIMENSIONS (mm)

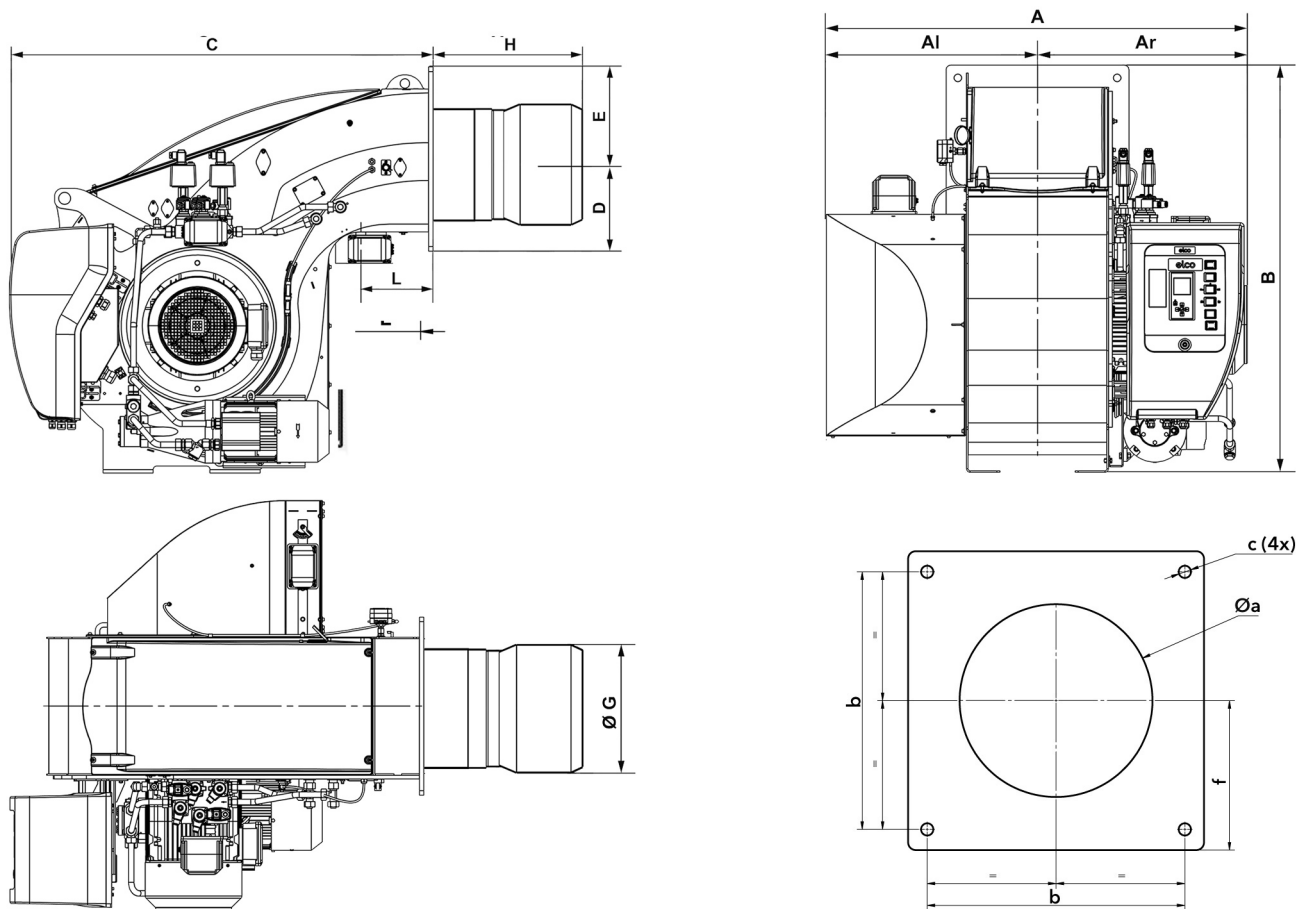

Model	A	Al	Ar	B	C	D	E	ØG	H			L	Øa	b	c	f
									KN	KM	KL					
EK EVO 8.5800	1336	670	666	1226	1354	391	288	400	562	702	842	230	430-480	505	M20	293
EK EVO 8.7100	1336	670	666	1226	1354	391	288	415	583	723	863	230	445-480	505	M20	293
EK EVO 9.8700	1336	670	666	1291	1325	434	293	439	355	505	655	230	445-480	505	M20	293
EK EVO 9.10400	1400	670	700	1291	1325	434	293	439	355	505	655	230	445-480	505	M20	293

PACKAGING

The burner is delivered in 2 packages containing:

- burner body with mounted combustion head, boiler fixing accessories and technical documentation;
- gas train and filter.

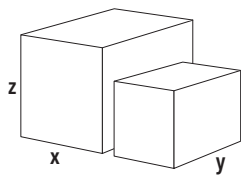

Models		Dimensions (mm)			Gross weight (kg)
		X	Y	Z	
EK EVO 8.5800 GL-E	KN	2200	1400	1396	615
	KM	2200	1400	1396	621
	KL	2200	1400	1396	632
EK EVO 8.7100 GL-E	KN	2200	1400	1396	631
	KM	2200	1400	1396	637
	KL	2200	1400	1396	648
EK EVO 9.8700 GL-E	KN	2200	1400	1461	658
	KM	2200	1400	1461	666
	KL	2200	1400	1461	673
EK EVO 9.10400 GL-E	KN	2200	1400	1461	680
	KM	2200	1400	1461	687
	KL	2200	1400	1461	699

PRESSURE LOSSES (BURNER HEAD + GAS TRAIN)

EK EVO 8.5800 GL-E

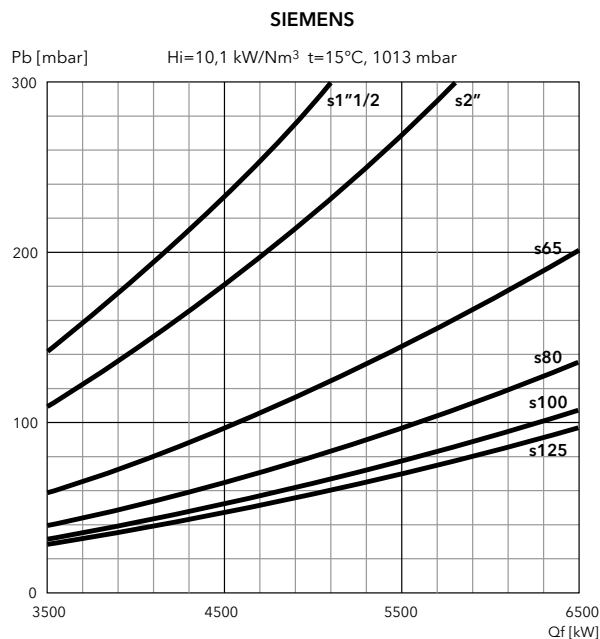
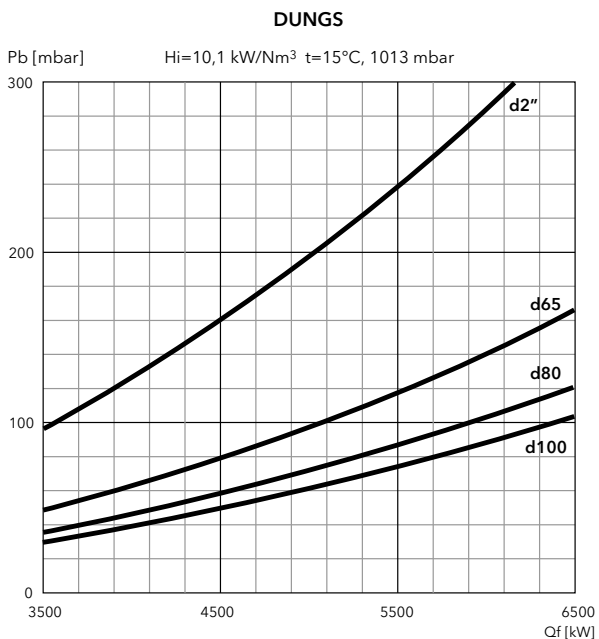

EK EVO 8.7100 GL-E

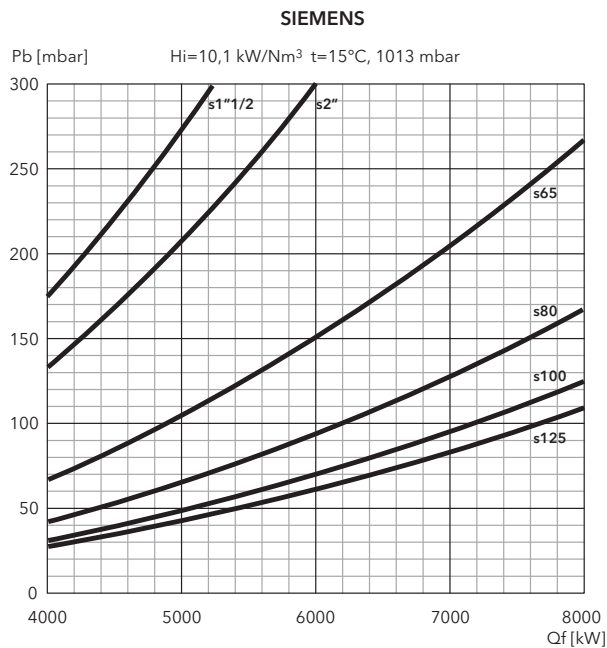
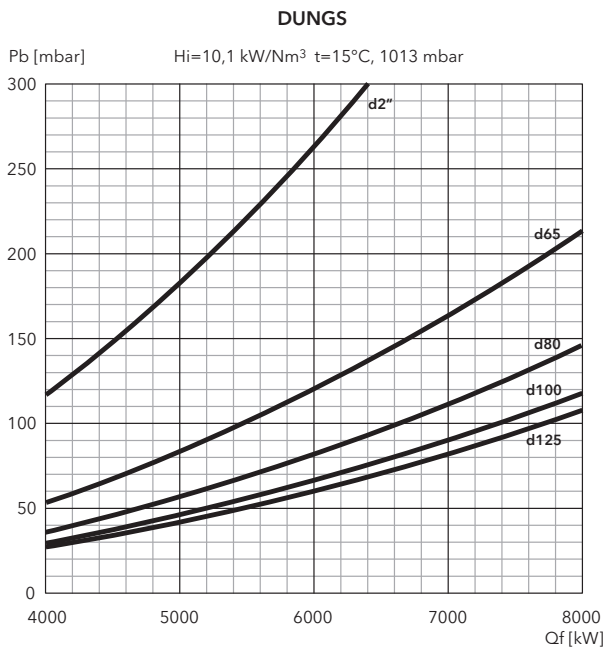

FILTERS

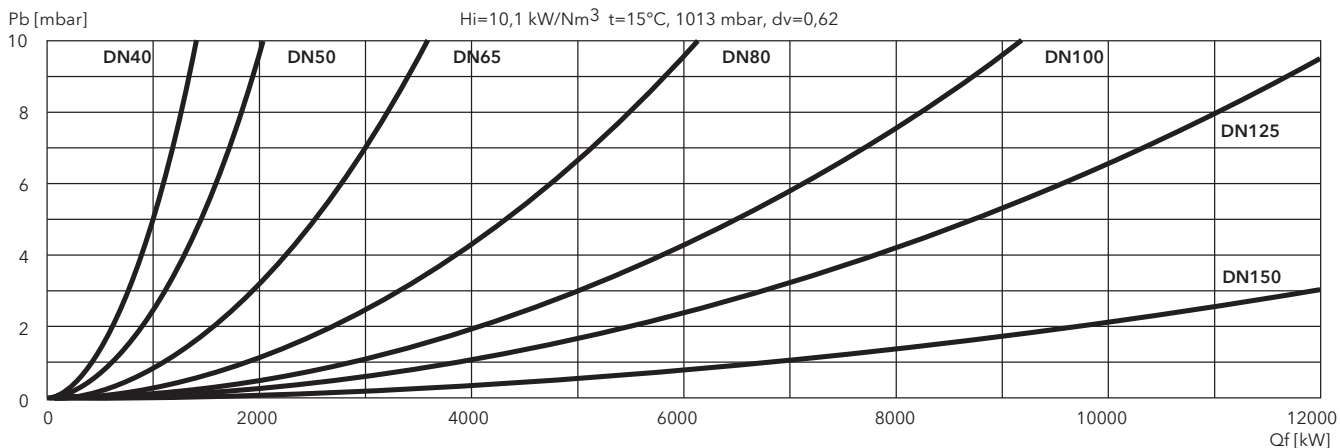

PRESSURE LOSSES (BURNER HEAD + GAS TRAIN)

EK EVO 9.8700 GL-E

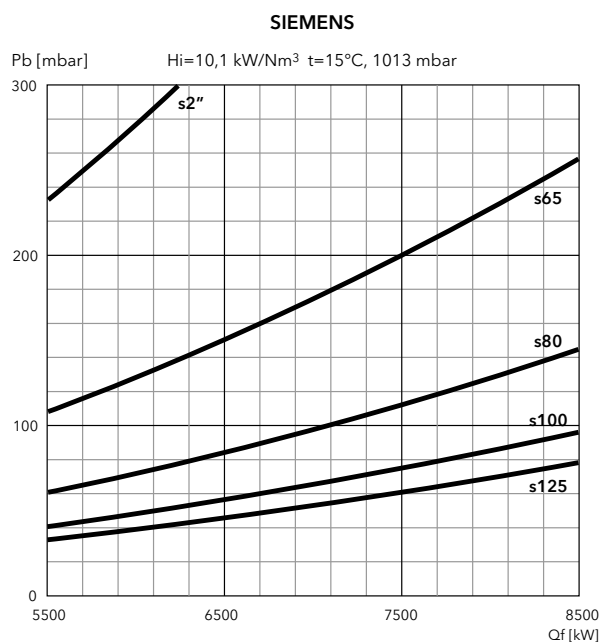
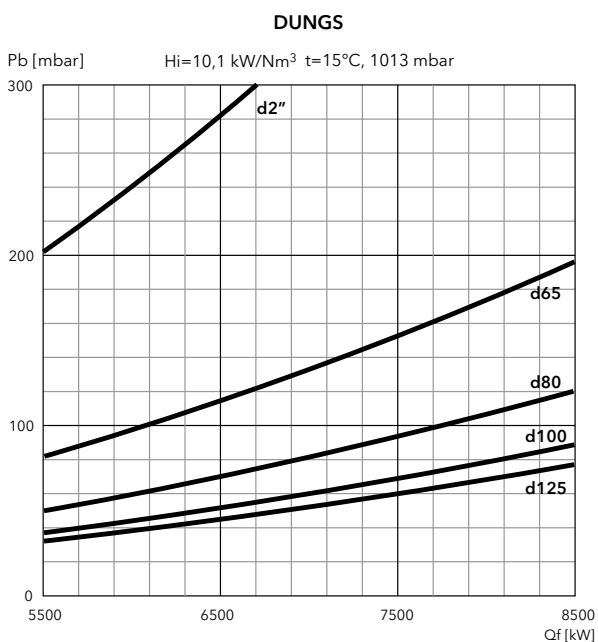

EK EVO 9.10400 GL-E

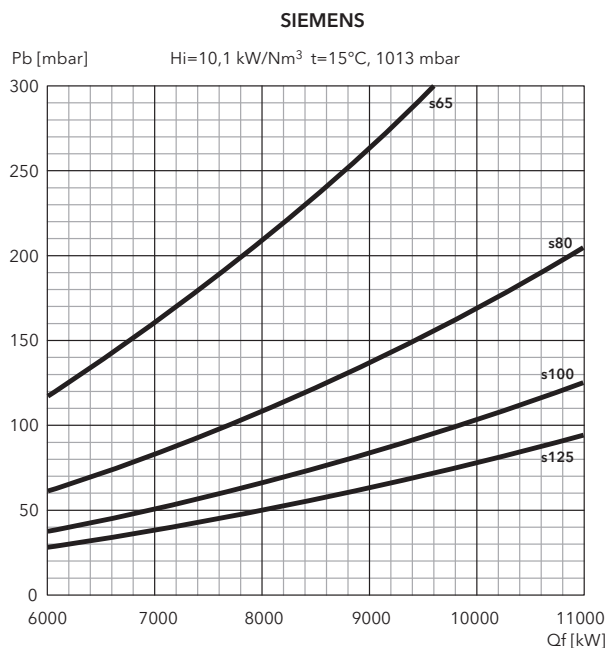
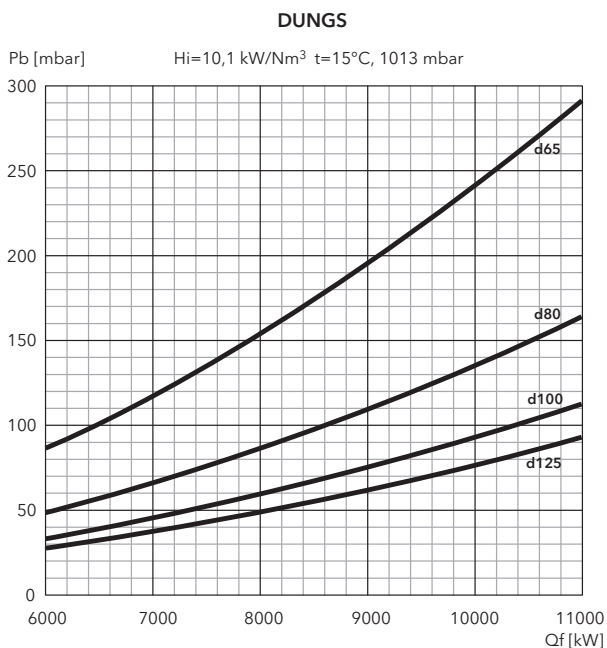

FILTERS

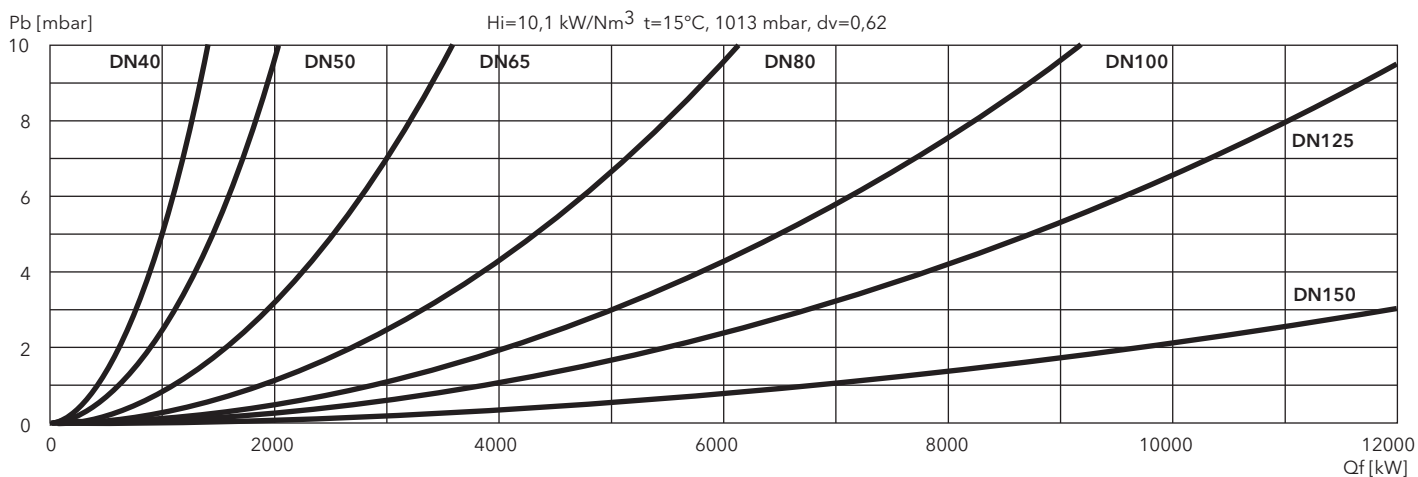

EKEVO 6 GL-EF3, EKEVO 7 GL-EF3

280 ... 4500 kW

2 stage progressive/modulating electronic in gas and in light oil (Low NOx class 3)

- **Fuels:** natural gas, low calorific value 6,99 ... 11,39 kWh/m³;
light oil, viscosity 6 mm²/s at 20°C, low calorific value 11,86 kWh/kg
- **Emission class:** Low NOx class 3 (<120 mg/kWh) according to EN676 in gas
Low NOx class 3 (<185 mg/kWh) according to EN267 in light oil
- **Electrical power supply:** single-phase 230 V - 50 Hz
- **Protection level:** IP 41



TECHNICAL DATA

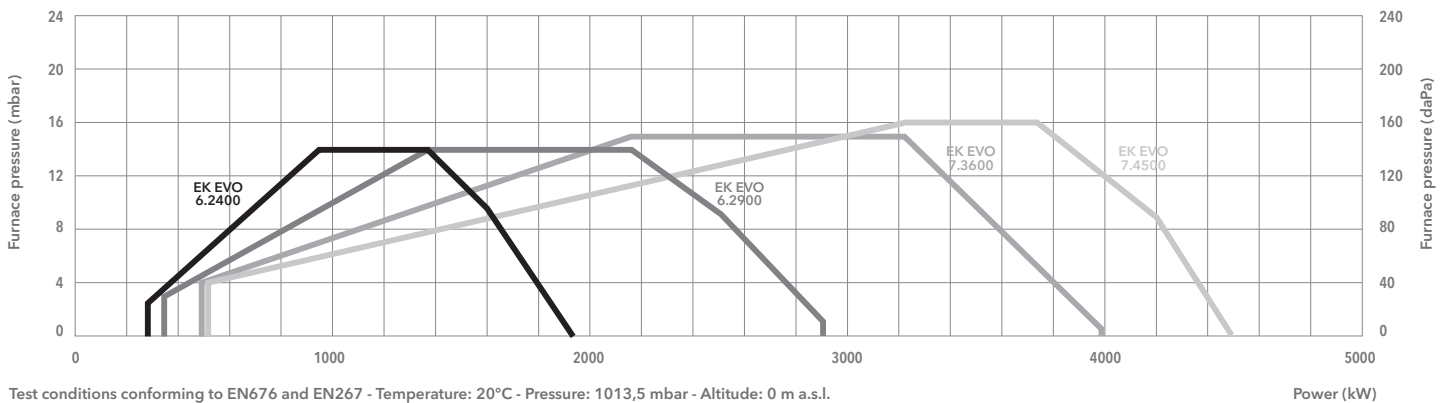

Test conditions conforming to EN676 and EN267 - Temperature: 20°C - Pressure: 1013,5 mbar - Altitude: 0 m a.s.l.

Power (kW)

	EK EVO 6.2400 GL-EF3	EK EVO 6.2900 GL-EF3	EK EVO 7.3600 GL-EF3	EK EVO 7.4500 GL-EF3
Operating range gas	280 - 1920 kW	340 - 2890 kW	470 - 3980 kW	510 - 4500 kW
Operating range oil	360 - 1920 kW	480 - 2890 kW	680 - 3980 kW	740 - 4500 kW
Gas pressure	50 - 500 mbar (50 - 360 mbar for d452 and d453)			
Control box / flame detector	BT300 / FFS08	BT300 / FFS08	BT300 / FFS08	BT300 / FFS08
Auxiliary voltage	1NPE AC 230 V - 50 Hz TN-S	1NPE AC 230 V - 50 Hz TN-S	1NPE AC 230 V - 50 Hz TN-S	1NPE AC 230 V - 50 Hz TN-S
Power supply	3PE AC 400 V - 50 Hz	3PE AC 400 V - 50 Hz	3PE AC 400 V - 50 Hz	3PE AC 400 V - 50 Hz
Fan motor	50 Hz - 3 kW	50 Hz - 4 kW	50 Hz - 7,5 kW	50 Hz - 7,5 kW
Acoustic level	<76 dB(A)	<77 dB(A)	<83 dB(A)	<81 dB(A)
CE certificate	00850CL0215	00850CL0215	00850CL0215	00850CL0215
Burner codes (body + head)	KN	3754521	3754522	3754523
	KM	3754525	3754526	3754527
	KL	3754529	3754530	3754531

GAS TRAINS

DUNGS

Model	Code
GT-d452-1"1/2 (*)	3750510
GT-d453-2" (*)	3750511
GT-d454-65	3750512
GT-d455-80	3750513
GT-d456-100	3750514

SIEMENS

Model	Code
GT-s451-1"1/2	3750525
GT-s452-2"	3750526
GT-s453-65	3750527
GT-s454-80	3750528
GT-s455-100	3750529
GT-s456-125	3750530

FILTERS

Model	Code
FG-Rp1"1/2	3750543
FG-Rp2"	3750544
FG-DN65	3750545
FG-DN80	3750546
FG-DN100	3750547
FG-DN125	3750548

*: integrated filter

Pressure drops graphs: see following pages
Dimensions of gas trains and gas filters: see pag. 200



DIMENSIONS (mm)

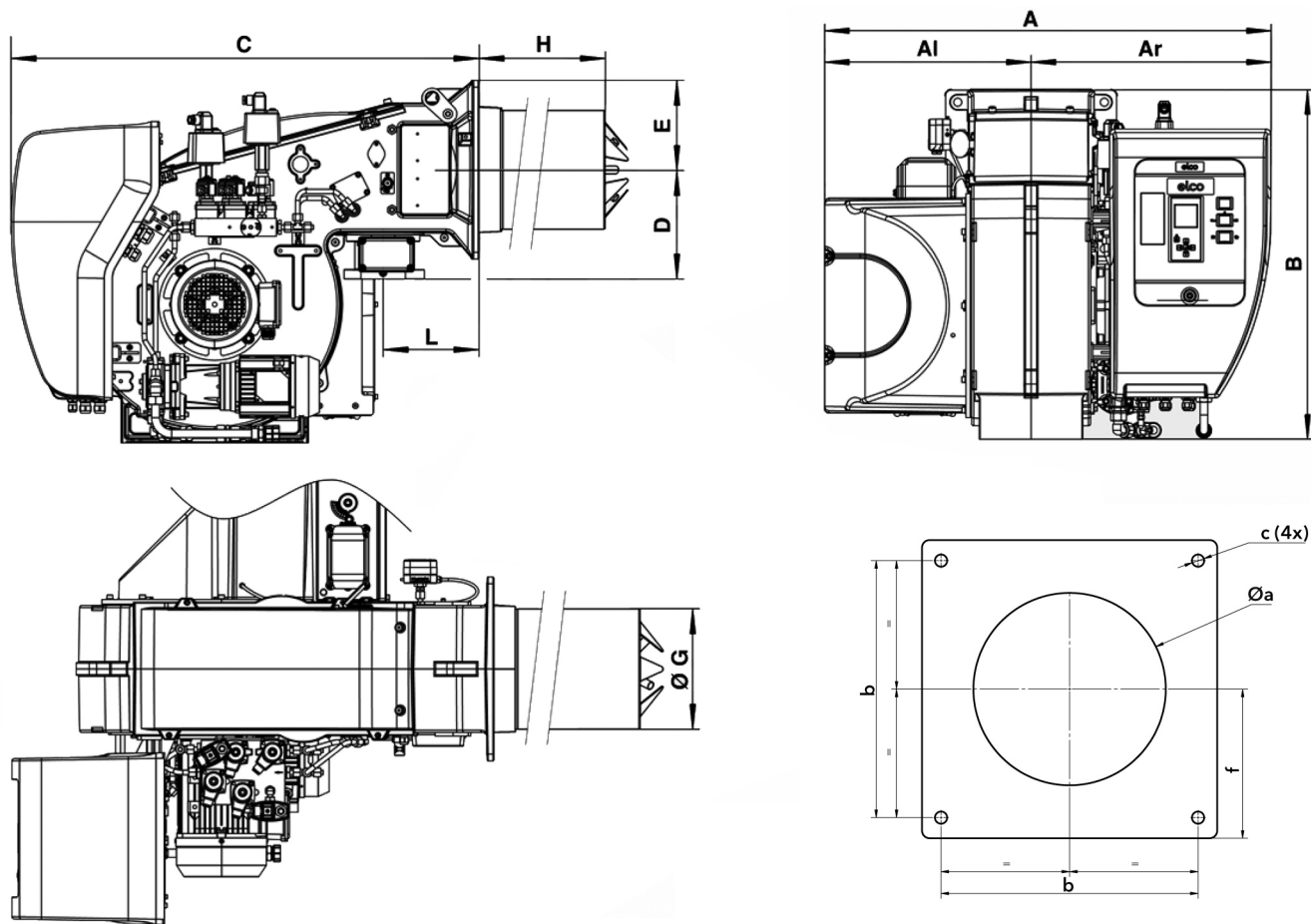

Model	A	Al	Ar	B	C	D	E	ØG	H			L	Øa	b	c	f
									KN	KM	KL					
EK EVO 6.2400	1035	479	556	812	1048	245	200	264	400	520	640	215	300-340	340	M16	200
EK EVO 6.2900	1035	479	556	812	1048	245	200	264	400	520	640	215	300-340	340	M16	200
EK EVO 7.3600	1093	506	587	941	1122	276	235	325	420	550	680	225	360-400	400	M16	235
EK EVO 7.4500	1093	506	587	941	1122	276	235	325	420	550	680	225	360-400	400	M16	235

PACKAGING

- The burner is delivered in 2 packages containing:
- burner body with mounted combustion head, boiler fixing accessories and technical documentation;
 - gas train and filter.

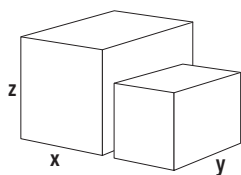

Models		Dimensions (mm)			Gross weight (kg)
		X	Y	Z	
EK EVO 6.2400 GL-EF3	KN	2070	1420	990	188
	KM	2070	1420	990	190
	KL	2070	1420	990	192
EK EVO 6.2900 GL-EF3	KN	2070	1420	990	194
	KM	2070	1420	990	196
	KL	2070	1420	990	198
EK EVO 7.3600 GL-EF3	KN	2070	1420	1130	243
	KM	2070	1420	1130	245
	KL	2070	1420	1130	247
EK EVO 7.4500 GL-EF3	KN	2070	1420	1130	243
	KM	2070	1420	1130	245
	KL	2070	1420	1130	247

PRESSURE LOSSES (BURNER HEAD + GAS TRAIN)

EK EVO 6.2400 GL-EF3

DUNGS

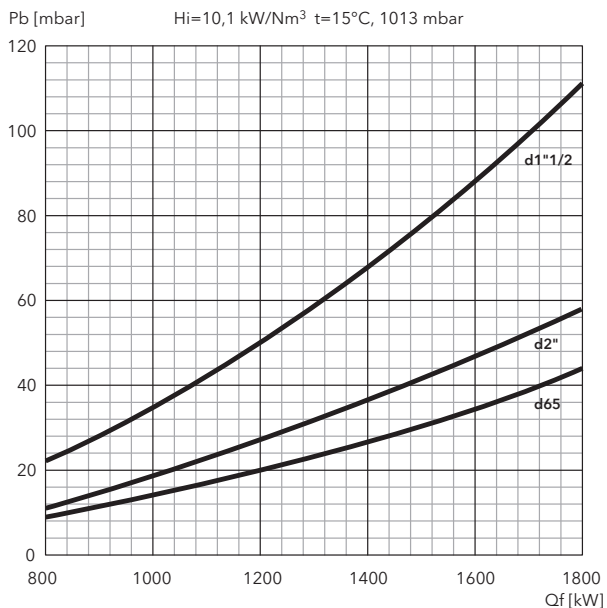

SIEMENS

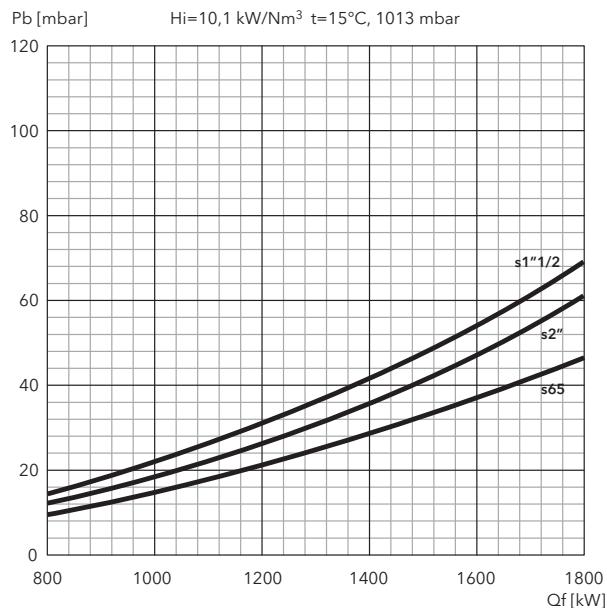

EK EVO 6.2900 GL-EF3

DUNGS

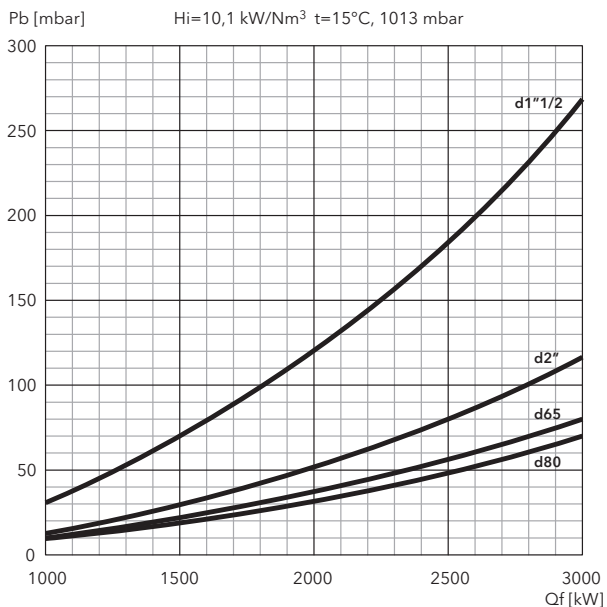

SIEMENS

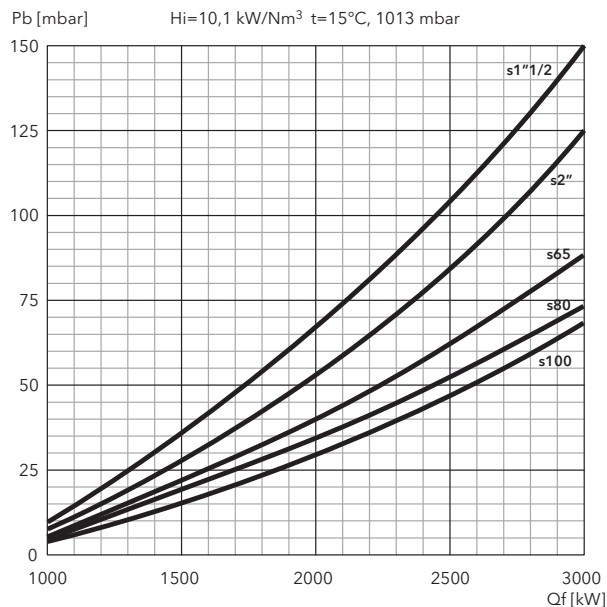

FILTERS

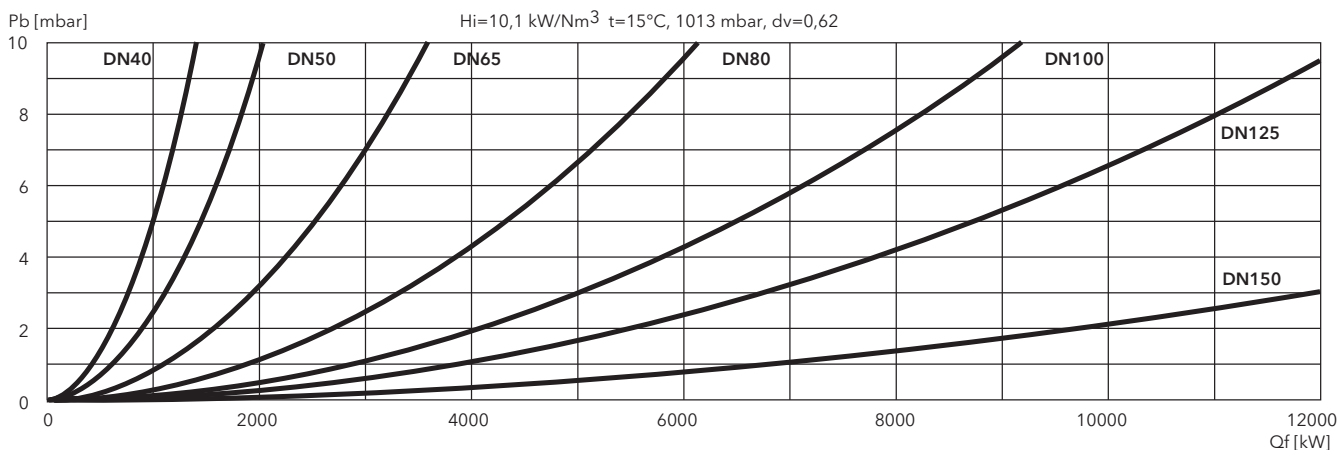

PRESSURE LOSSES (BURNER HEAD + GAS TRAIN)

EK EVO 7.3600 GL-EF3

DUNGS

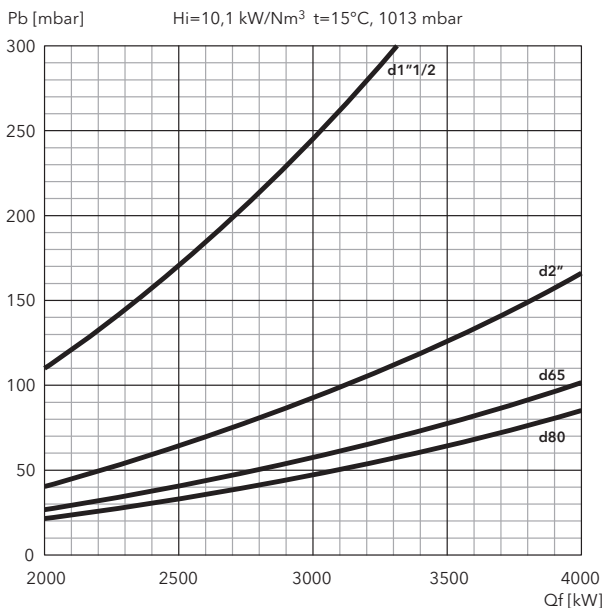

SIEMENS

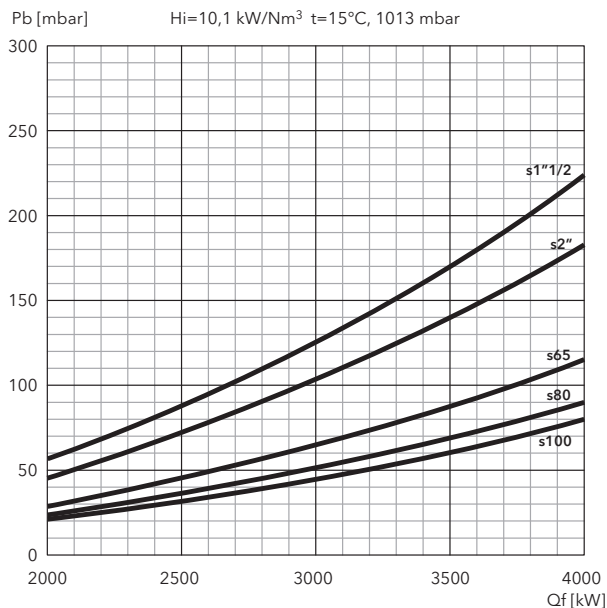

EK EVO 7.4500 GL-EF3

DUNGS

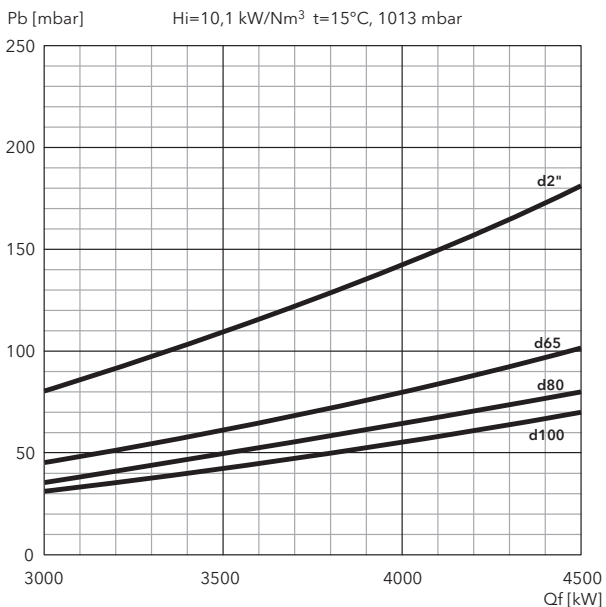

SIEMENS

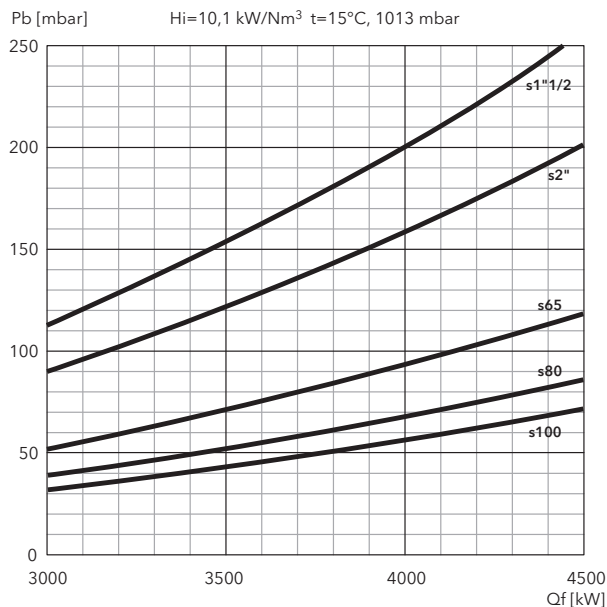

FILTERS

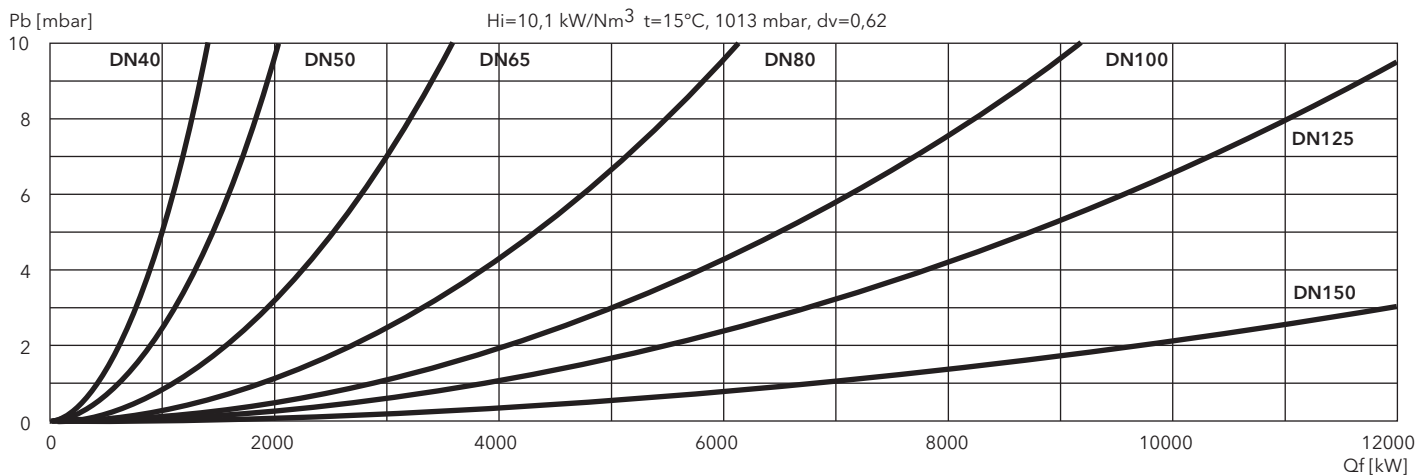

EKEVO 8/9 GL-EF3, EKEVO 9 GL-EUF

830 ... 9570 kW

2 stage progressive/modulating electronic in gas and in light oil (Low NOx class 3)

- **Fuels:** natural gas, low calorific value 6,99 ... 11,39 kWh/m³;
light oil, viscosity 6 mm²/s at 20°C, low calorific value 11,86 kWh/kg
- **Emission class:** Low NOx class 3 (<80 mg/kWh) according to EN676 in gas
Low NOx class 3 (<120 mg/kWh) according to EN267 in light oil
- **Electrical power supply:** single-phase 230 V - 50 Hz
- **Protection level:** IP 41

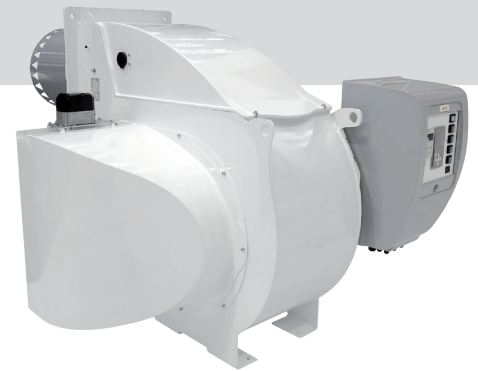

TECHNICAL DATA

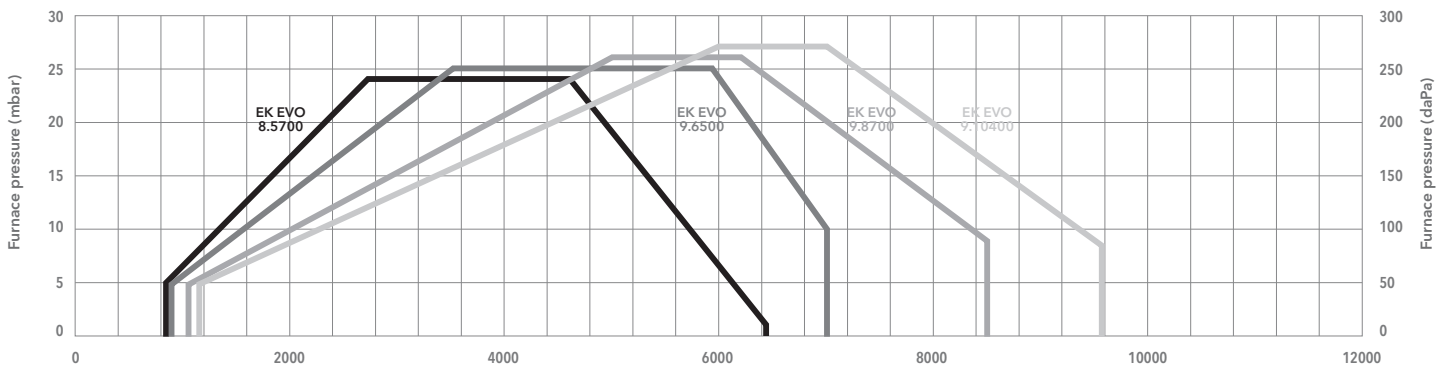

Test conditions conforming to EN676 and EN267 - Temperature: 20°C - Pressure: 1013,5 mbar - Altitude: 0 m a.s.l.

Power (kW)

	EK EVO 8.5700 GL-EF3	EK EVO 9.6500 GL-EF3	EK EVO 9.8700 GL-EUF	EK EVO 9.10400 GL-EUF
Operating range gas	830 - 6450 kW	860 - 6950 kW	1040 - 8500 kW	1160 - 9570 kW
Operating range oil	1100 - 6450 kW	1100 - 6600 kW	1800 - 8500 kW	2550 - 9570 kW
Gas pressure	100 - 500 mbar (100 - 360 mbar for d457)			
Control box / flame detector	BT300 / FFS08	BT300 / FFS08	BT300 / FFS08	BT300 / FFS08
Auxiliary voltage	1NPE AC 230 V - 50 Hz TN-S	1NPE AC 230 V - 50 Hz TN-S	1NPE AC 230 V - 50 Hz TN-S	1NPE AC 230 V - 50 Hz TN-S
Power supply	3PE AC 400 V - 50 Hz	3PE AC 400 V - 50 Hz	3PE AC 400 V - 50 Hz	3PE AC 400 V - 50 Hz
Fan motor	50 Hz - 15 kW	50 Hz - 22 kW	50 Hz - 18,5 kW	50 Hz - 22 kW
Acoustic level	<80,2 dB(A)	<82,9 dB(A)	<85,9 dB(A)	<86,6 dB(A)
CE certificate	00850CL0215	00850CL0215	00850CL0215	00850CL0215
Burner codes (body + head)	KN	3754825	3754826	3754827
	KM	3754829	3754830	3754831
	KL	3754833	3754834	3754835

GAS TRAINS

DUNGS

Model	Code
GT-d457-2" (*)	3750515
GT-d458-65	3750516
GT-d459-80	3750517
GT-d460-100	3750518

SIEMENS

Model	Code
GT-s457-2"	3750537
GT-s458-65	3750538
GT-s459-80	3750539
GT-s460-100	3750540
GT-s461-125	3750541

FILTERS

Model	Code
FG-Rp2"	3750544
FG-DN65	3750545
FG-DN80	3750546
FG-DN100	3750547
FG-DN125	3750548

*: integrated filter

i Pressure drops graphs: see following pages
Dimensions of gas trains and gas filters: see pag. 201



DIMENSIONS (mm)

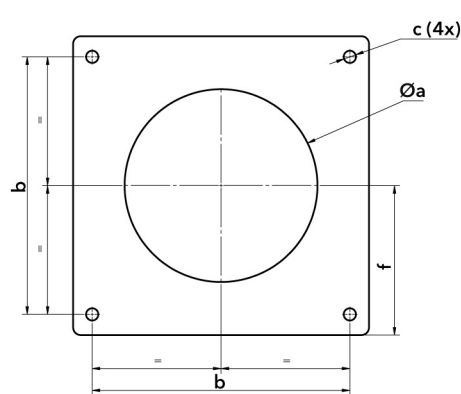
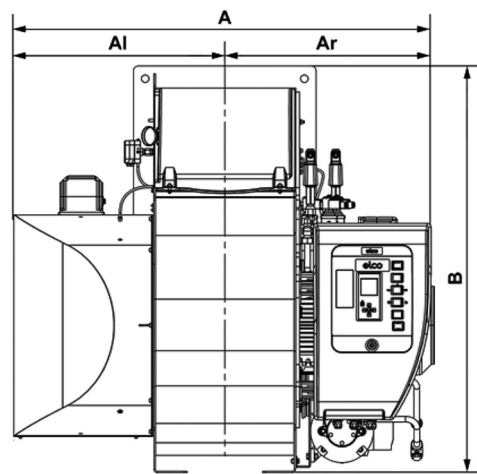
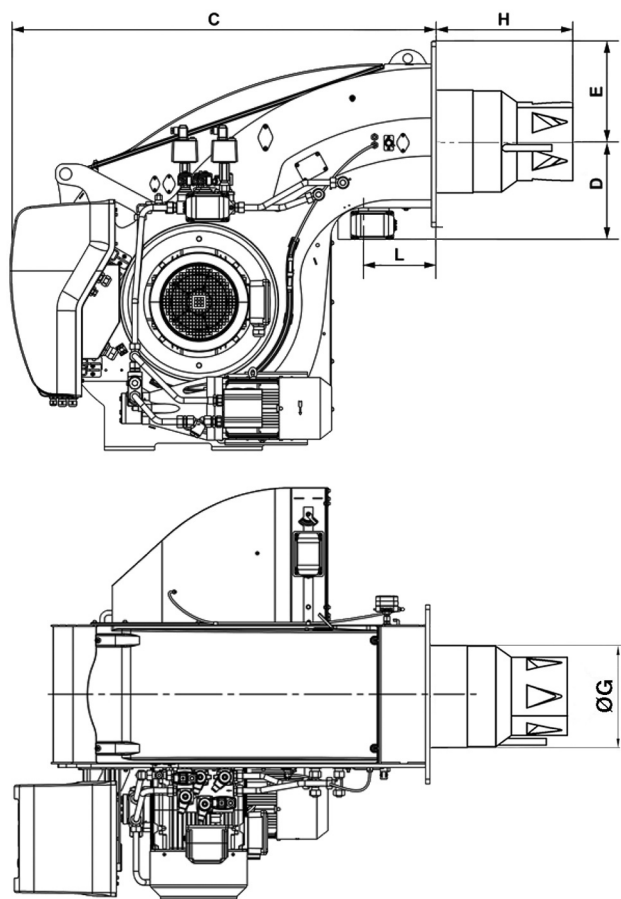

Model	A	Al	Ar	B	C	D	E	ØG	H			L	Øa	b	c	f
									KN	KM	KL					
EK EVO 8.5700	1336	670	666	1226	1354	307	288	376	528	668	808	230	380 - 410	505	M20	293
EK EVO 9.6500	1336	670	666	1291	1325	322	293	439	543	693	843	230	445 - 480	505	M20	293
EK EVO 9.8700	1336	670	666	1291	1325	322	293	439	575	725	875	230	445 - 480	505	M20	293
EK EVO 9.10400	1400	670	700	1291	1325	322	293	439	575	725	875	230	445 - 480	505	M20	293

PACKAGING

- The burner is delivered in 2 packages containing:
- burner body with mounted combustion head, boiler fixing accessories and technical documentation;
 - gas train and filter.

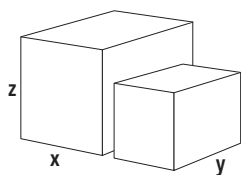

Models		Dimensions (mm)			Gross weight (kg)
		X	Y	Z	
EK EVO 8.5700 GL-EF3	KN	2000	1200	1087	369
	KM	2000	1200	1087	369
	KL	2000	1200	1087	369
EK EVO 9.6500 GL-EF3	KN	2000	1200	1087	369
	KM	2000	1200	1087	369
	KL	2000	1200	1087	369
EK EVO 9.8700 GL-EUF	KN	2000	1200	1087	369
	KM	2000	1200	1087	369
	KL	2000	1200	1087	369
EK EVO 9.10400 GL-EUF	KN	2000	1200	1087	369
	KM	2000	1200	1087	369
	KL	2000	1200	1087	369

PRESSURE LOSSES (BURNER HEAD + GAS TRAIN)

EK EVO 8.5700 GL-EF3

DUNGS

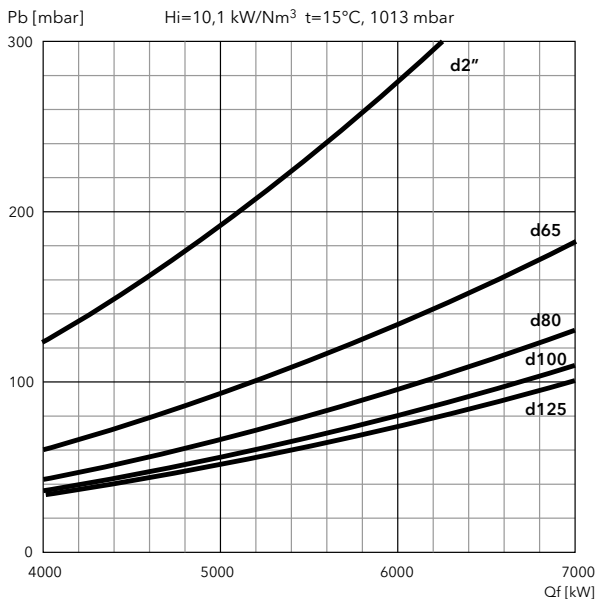

SIEMENS

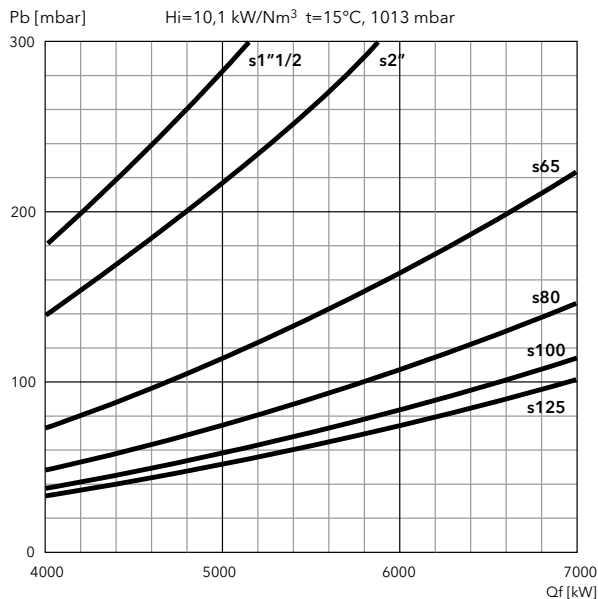

EK EVO 9.6500 GL-EF3

DUNGS

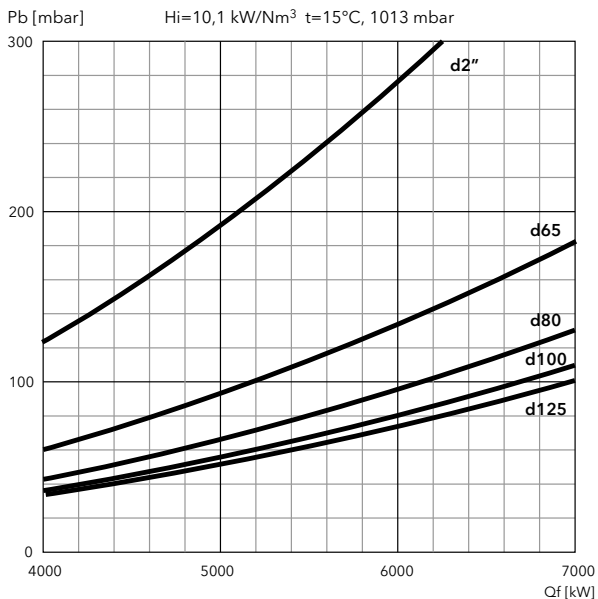

SIEMENS

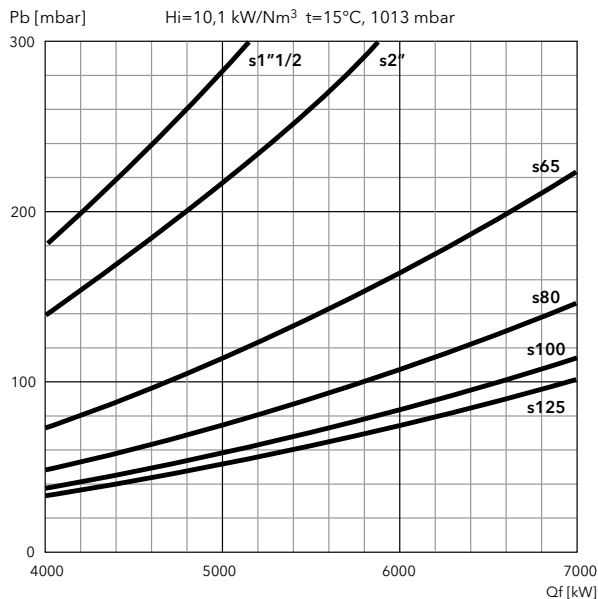

FILTERS

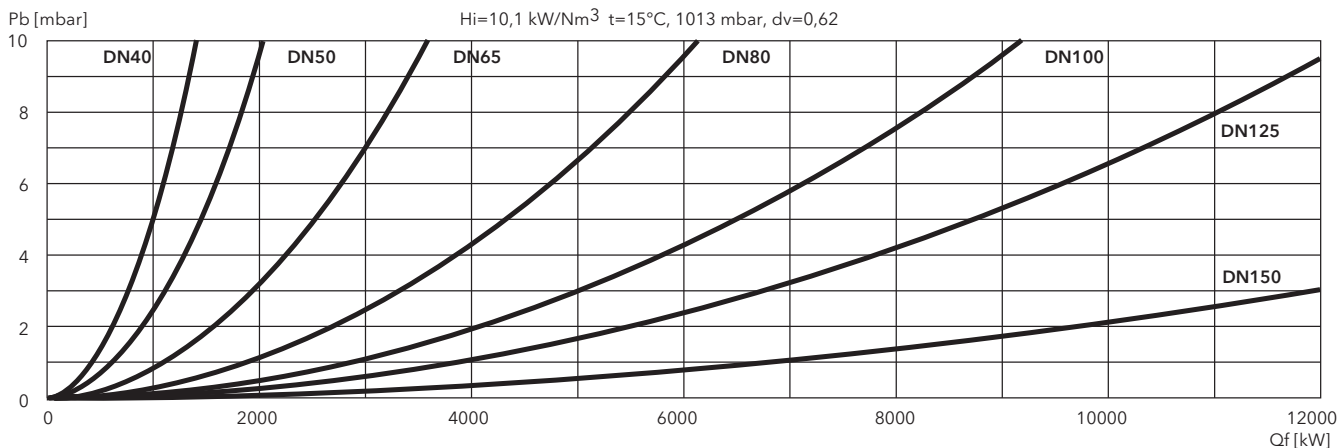

PRESSURE LOSSES (BURNER HEAD + GAS TRAIN)

EK EVO 9.8700 GL-EUF

DUNGS

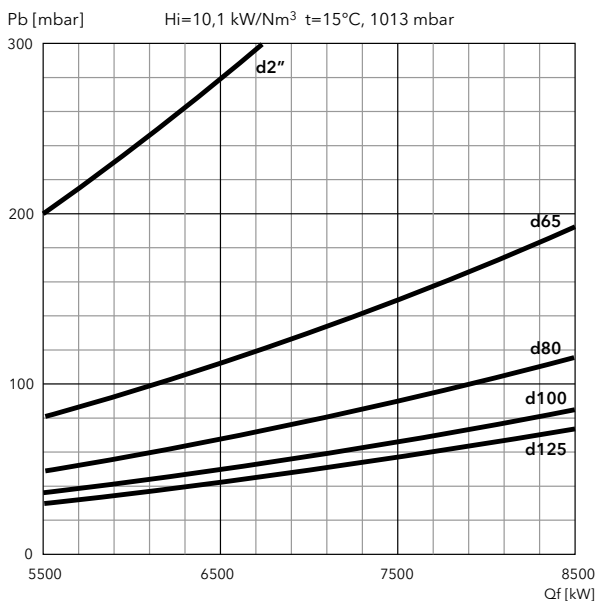

SIEMENS

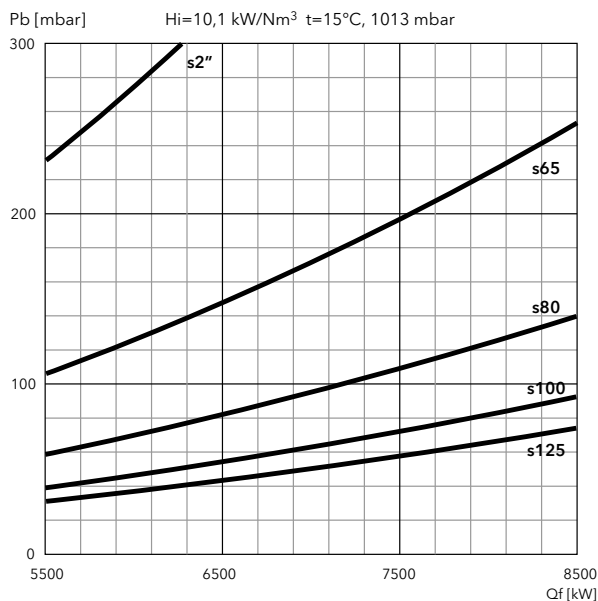

EK EVO 9.10400 GL-EUF

DUNGS

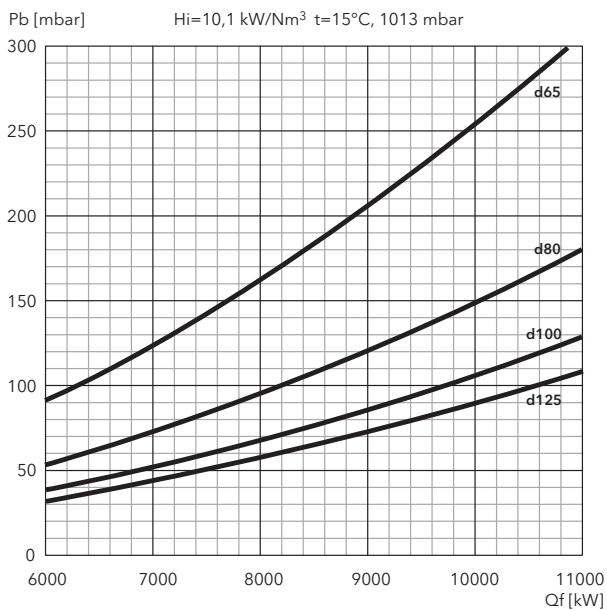

SIEMENS

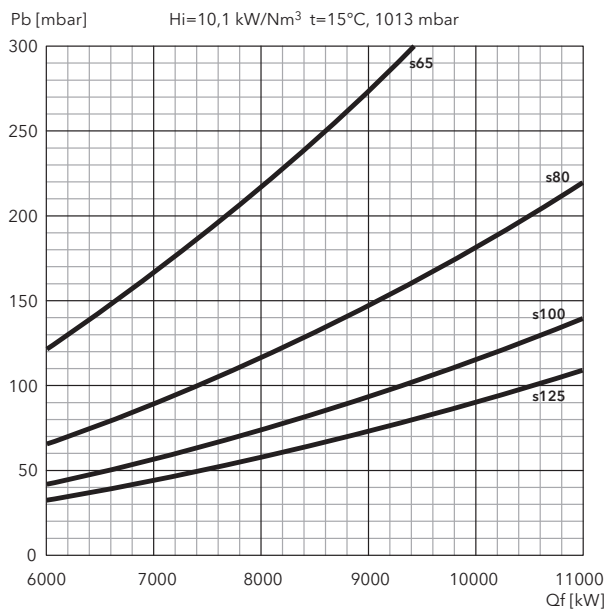

FILTERS

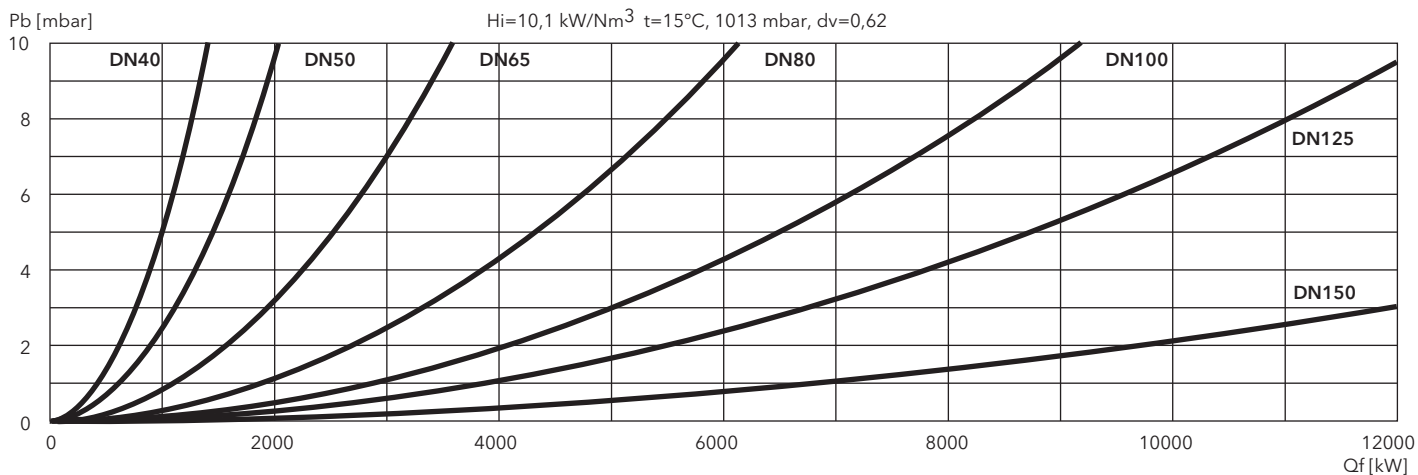

BURNER VARIANTS (options already mounted in factory)

LCM MODULE (for communication, O₂ control, frequency converter)

Module mounted in factory, requested for O₂ control, Variatron and communication buses connections (the module is available also on request as a separate kit) Note: only one LCM module is necessary for these 3 options For all dual fuel models the LCM module is already included	3751645
---------------------------------------------------------------------------------------------------------------------------------------------------------------------------------------------------------------------------------------------------------------------------------------------------------------	----------------

MODULATING OPERATION

RS55 (Regulator RWF55 + instruction manual) , mounted in factory on the switch cabinet – to be connected to the appropriate probe (see "BURNER KITS" session)	for EK EVO 6...9 G... and EK EVO 6...9 GL-E/GL-EF3/GL-EUF	3751646
	for EK EVO 6/7 GL-EZ3	3751647

FREQUENCY CONVERTER ARRANGEMENT

Burner prepared to be connected to an external frequency converter; this variant includes the VSM module to control the frequency converter, LCM module must be ordered separately

EK EVO 6.2400 G-E/G-EF3 prepared for an external frequency converter of 3 kW	3751673
EK EVO 6.2900 G-E/G-EF3 prepared for an external frequency converter of 4 kW	3751674
EK EVO 7.3600 G-E prepared for an external frequency converter of 5,5 kW	3751675
EK EVO 7.3600 G-EF3 and EK EVO 7.4500 G-E/G-EF3 prepared for an external frequency converter of 7,5 kW	3751676
EK EVO 8.5800 G-E/G-EU3 prepared for an external frequency converter of 11 kW	3754025
EK EVO 8.7100 G-E/G-EU3 prepared for an external frequency converter of 15 kW	3754026
EK EVO 9.8700 G-E/G-EU3 prepared for an external frequency converter of 18,5 kW	3754027
EK EVO 9.10400 G-E/G-EU3 prepared for an external frequency converter of 22 kW	3754028
EK EVO 6.2400 GL-... prepared for an external frequency converter of 3 kW	3751677
EK EVO 6.2900 GL-... prepared for an external frequency converter of 4 kW	3751678
EK EVO 7.3600 GL-E prepared for an external frequency converter of 5,5 kW	3751679
EK EVO 7.3600 GL-EF3 and EK EVO 7.4500 GL-E/GL-EF3 prepared for an external frequency converter of 7,5 kW	3751680
EK EVO 8.5800 GL-E prepared for an external frequency converter of 11 kW	3755057
EK EVO 8.7100 GL-E and EK EVO 8.5700 GL-EF3 prepared for an external frequency converter of 15 kW	3755058
EK EVO 9.8700 GL-E/GL-EUF prepared for an external frequency converter of 18,5 kW	3755059
EK EVO 9.10400 GL-E/GL-EUF and EK EVO 9.6500 GL-EF3 prepared for an external frequency converter of 22 kW	3755060

MAX GAS PRESSURE SWITCH (mounted on the gas train)

EK EVO 6/7	with Siemens threaded gas trains	3751669
	with Siemens flanged gas trains	3751670
	with Dungs threaded gas trains	3751671
	with Dungs flanged gas trains	3751672
EK EVO 8/9	with Siemens threaded gas trains	3754021
	with Siemens flanged gas trains	3754022
	with Dungs threaded gas trains	3754023
	with Dungs flanged gas trains	3754024

STAR/DELTA MOTOR STARTER

Star/Delta 4,0 G/BT3 for EK EVO 6.2900 G-E, G-EF3, GL-EZ3 and GL-E, GL-EF3	3751650
Star/Delta 5,5 G/BT3 for EK EVO 7.3600 G-E, GL-EZ3 and GL-E	3751651
Star/Delta 7,5 G/BT3 for EK EVO 7.3600 G-EF3, GL-EF3 and EK EVO 7.4500 G-E, G-EF3, GL-EZ3 GL-E, GL-EF3	3751652

PED EQUIPMENT

Equipment of the gas train and the burner body for continuous operation (PED):

- controller and flame sensor approved for continuous operation,
- maximum gas pressure switch on the gas train,
- test burner (to bleed the gas train),
- PED Conformity Declaration.

Note: if required, the antivibrating coupling (to avoid mechanical tension) has to be selected as option

PED for EK EVO 6/7 G-E	with Siemens threaded gas trains	3751653
	with Siemens flanged gas trains	3751654
	with Dungs threaded gas trains	3751655
	with Dungs flanged gas trains	3751656
PED for EK EVO 6/7 G-EF3	with Siemens threaded gas trains	3751665
	with Siemens flanged gas trains	3751666
	with Dungs threaded gas trains	3751667
	with Dungs flanged gas trains	3751668
PED for EK EVO 8/9 G-E and EK EVO 8/9 G-EU3	with Siemens threaded gas trains	3754010
	with Siemens flanged gas trains	3754011
	with Dungs threaded gas trains	3754019
	with Dungs flanged gas trains	3754020
PED for EK EVO 6/7 GL-EZ3 and EK EVO 6/7 GL-E	with Siemens threaded gas trains	3751657
	with Siemens flanged gas trains	3751658
	with Dungs threaded gas trains	3751659
	with Dungs flanged gas trains	3751660
PED for EK EVO 8/9 GL-E	with Siemens threaded gas trains	3755055
	with Siemens flanged gas trains	3755056
	with Dungs threaded gas trains	3755053
	with Dungs flanged gas trains	3755054
PED for EK EVO 6/7 GL-EF3	with Siemens threaded gas trains	3755067
	with Siemens flanged gas trains	3755068
	with Dungs threaded gas trains	3755065
	with Dungs flanged gas trains	3755066
PED for EK EVO 8/9 GL-EU3/GL-EUF	with Siemens threaded gas trains	3755063
	with Siemens flanged gas trains	3755064
	with Dungs threaded gas trains	3755061
	with Dungs flanged gas trains	3755062

BURNER KITS (delivered separately)
O₂/CO REGULATION

Device for adjustment of the combustion air excess in order to compensate any variations in the calorific value of the fuel, in the temperature and in the pressure of the combustion air. The regulator is installed in a dedicated electrical panel separate from the burner near the probe that measures the level of oxygen in the fumes. The calibration of the probe does not require a reference gas, the correction curve is defined in the dedicated equipment for acquisition and processing of signals and then sent to the control unit BT3xx via the external module LCM. The correction of the air excess value is carried out on the position of the air damper and the fan speed controller ensuring a high and constant thermal efficiency during the whole heating season. The value of air excess is immediately displayed on the screen as a percentage.

Kit for O₂ and CO control Note: LCM module is required	Kit O ₂ LT2/LS2 / 300 mm	3751129
	Kit O ₂ /CO LT2/KS1 / 300 mm	3751128
Fail-safe kit for O₂ and CO control (LT3-F + KS1D + connection box) Note: LCM module is required	Analog Output 4...20 / 300 mm Probe (GED)	3754549
	Analog Output 4...20 / 450 mm Probe (GED)	3754550
	Analog + Digital Output 4...20 / 300 mm Probe (GED)	3754551
	Analog + Digital Output 4...20 / 300 mm Probe (GED)	3754552

REMOTE SOFTWARE

Kit to connect a PC laptop to the BT300 for its parametrization	LSA100 + USB/CAN + CD-Rom	3751130
-----------------------------------------------------------------	---------------------------	----------------

COMMUNICATION MODULES

Module for external installation Note: LCM module is required	ModBus/BT3	on request
	ProfiBus/BT3	3752986
	Ethernet/BT3	in progress

POWER REGULATOR

Power regulator RWF55 stand-alone and kit wiring	3753358
--------------------------------------------------	----------------

PROBES

Immersion probes	130°C + pocket tube	3750070
	Pt 100 - 400°C (160 mm)	1758574269
	Pt 100 - 480°C (250 mm)	3751009
Pressure probes	0...1,6 bar	3752217
	0...2,5 bar	1758713722
	0...6 bar	1758640660
	0...10 bar	1758577280
	0...16 bar	1758577291
	0...25 bar	3751015

EXTERNAL AIR INLET CONNECTION KIT

Connection for external air channel for EK EVO 6 and EK EVO 7	3752987
Connection for external air channel for EK EVO 8 and EK EVO 9	3754031

SPECIAL CONFIGURATIONS (on request)

- Equipment according EN746-2
- permanent ventilation, 60 Hz versions
- remote display (BT3xx)
- separate switch box / terminal strip version (Etamatic OEM)
- LFP firing
- hinge flange
- "Burner ON" feedback signal

Other special requests can be submitted to your Sales Reference for feasibility evaluation

Monoblock burners from 250 to 11200 kW Gas, light oil and dual fuel



Design: smooth and integral

The original design of NEXTRON® range is the result of a successful integration between burner and ELCO technologies. NEXTRON® burners are able to perfectly integrate themselves in any installation and professionals will appreciate the innovative construction that ease maintenance.

Unique Low NOx performance

Developed and improved by ELCO R&D department, the Free Flame technology is a unique combustion process. This ELCO technology is capable to reach the NOx levels required by the most severe standards for all types of combustion chambers, whether they are 3-pass or reverse pass boilers.

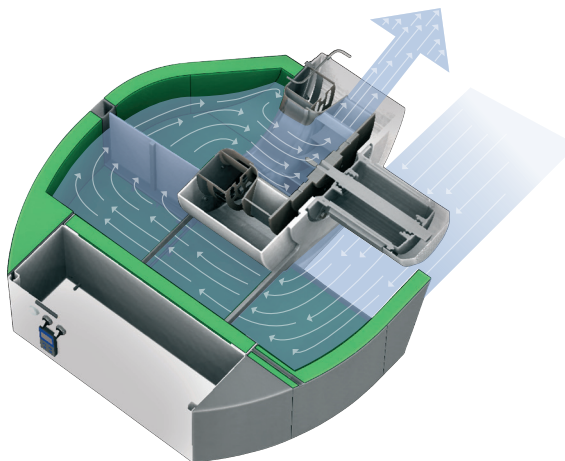
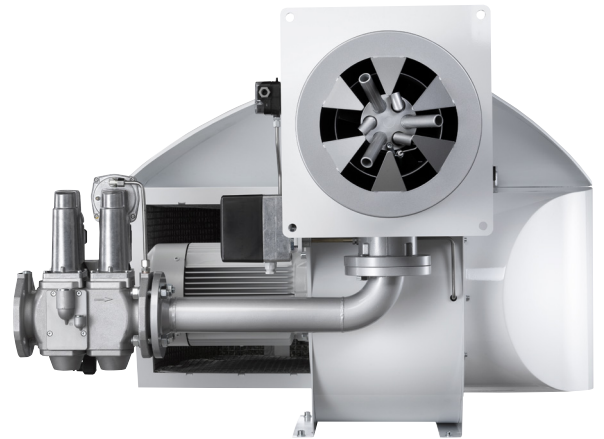

High acoustic comfort

The NEXTRON® burner range offers a high acoustic comfort thanks to the Low Noise System. The unique air intake channel is carefully designed to achieve an acoustic level significantly lower than 80 dB(A) up to 10 MW. This integrated and patented system on all NEXTRON® burners is definitely a good replacement of the traditional bulky sound proofing box.

Built-in and modular switch cabinet

All the NEXTRON® burners feature integrated switch cabinet, the ISC System, with modular concept for control devices and accessories:

- adjusting and safety control box
- EMC protected power circuit of fan motor
- display with command keyboard in front of the panel

The ISC System houses options and accessories, such as the power regulator and the frequency inverter Variatron, and customizes each burner according to the installation needs.



MAIN TECHNICAL FEATURES

- Two stage progressive/modulating forced draught burner.
- Fuels:
 - natural gas, low calorific value 6,99...11,39 kWh/Nm³
 - LPG, low calorific value 25,89 kWh/Nm³
 - light oil, viscosity 6 mm²/s at 20°C, low calorific value 11,86 kWh/kg
- Combustion technology:
 - Low NOx class 2 (<120 mg/kWh) and class 3 (<80 mg/kWh) in gas operation according to EN676
 - Low NOx class 2 (<185 mg/kWh) and class 3 (<120 mg/kWh) in light oil operation according to EN267
- Integrated switch cabinet (ISC System) with modular concept complete for an easy installation with:
 - BT300 control box (MDE2 System and display);
 - fan motor direct start-up;
 - enumerated connection terminals;
 - power regulator (option);
 - speed controller Variatron (option);
 - O₂ control (option);
 - Bus interface (option)
- Innovative design allowing easy access to burner components for fast start-up and reduced maintenance time and space
- Three flame tube lengths available
- Secured burner head adjustments during maintenance (RTC System)
- Unique air intake channel design (patented) to reduce acoustic levels (Low Noise System)
- Closing of the air damper on burner shut-down
- Multiple gas train matching according to the inlet gas pressure
- Gas train factory assembled and tested for tightness and electrical security
- Products are in compliance with EN676 and EN267 European standards and with the following directives:
 - 2014/35/UE Low Voltage Directive
 - 2014/30/UE EMC Directive
 - 2009/142/CEE Gas Appliances Directive
 - 2006/42/EC Machinery Directive
 - 2011/65/EU RoHS2 Directive

RANGE OVERVIEW

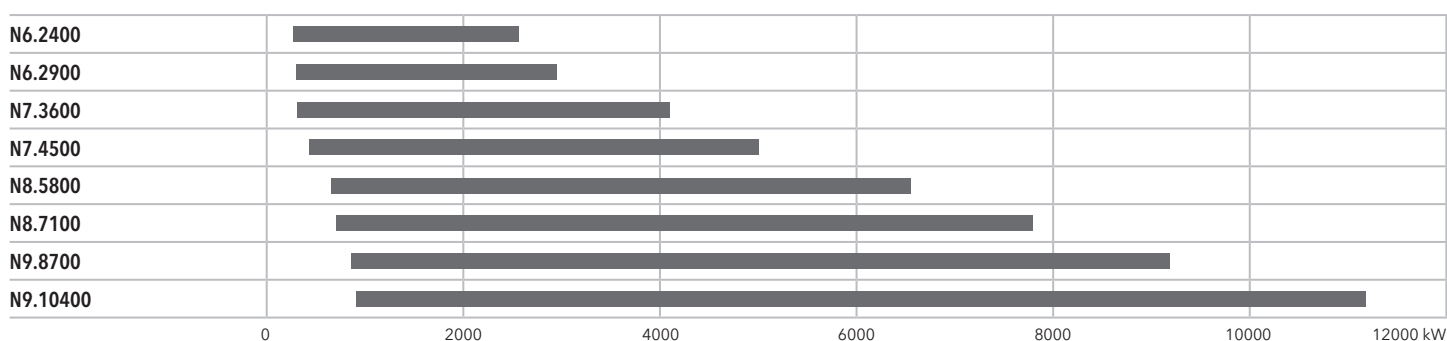

N6 G-R, N7 G-R

390 ... 5000 kW

2 stage progressive/modulating mechanical

- **Fuels:** natural gas, low calorific value 6,99 ... 11,39 kWh/m³;
LPG, low calorific value 25,89 kWh/m³
- **Emission class:** Low NO_x class 2 (<120 mg/kWh) according to EN676
- **Modulating ratio:** 1:5
- **Electrical power supply:** single-phase 230 V - 50 Hz
- **Protection level:** IP 41



TECHNICAL DATA

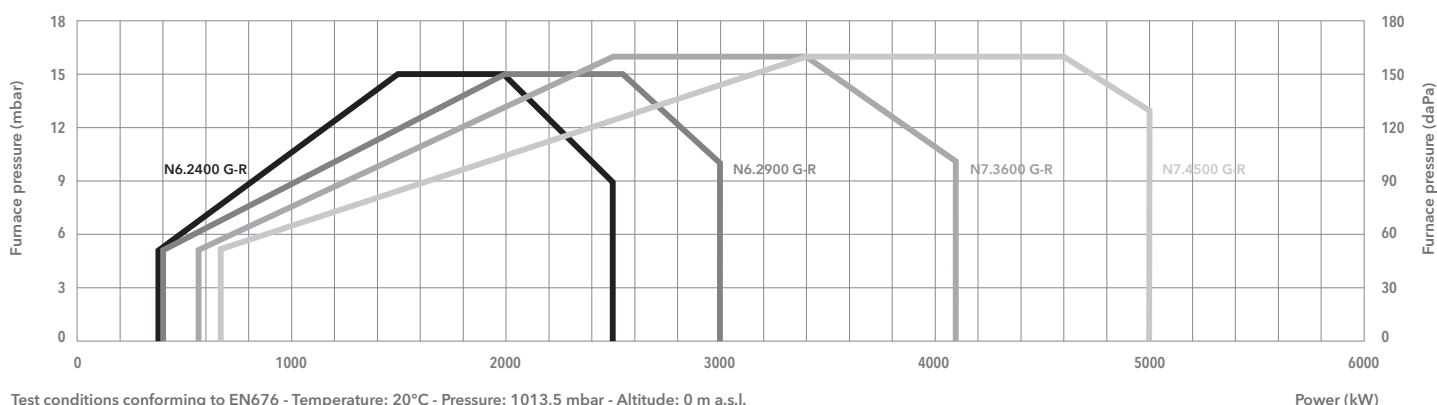

Test conditions conforming to EN676 - Temperature: 20°C - Pressure: 1013,5 mbar - Altitude: 0 m a.s.l.

Power (kW)

	N6.2400 G-R	N6.2900 G-R	N7.3600 G-R	N7.4500 G-R
Operating range	390 - 2500 kW	400 - 3000 kW	580 - 4100 kW	680 - 5000 kW
Gas pressure	50 - 500 mbar (50 - 360 mbar for d552 and d553 gas train)			
Control box / flame detector	LFL 1.333 / Ionisation	LFL 1.333 / Ionisation	LFL 1.333 / Ionisation	LFL 1.333 / Ionisation
Auxiliary voltage	1NPE AC 230 V - 50 Hz TN-S	1NPE AC 230 V - 50 Hz TN-S	1NPE AC 230 V - 50 Hz TN-S	1NPE AC 230 V - 50 Hz TN-S
Power supply	3PE AC 400 V - 50 Hz	3PE AC 400 V - 50 Hz	3PE AC 400 V - 50 Hz	3PE AC 400 V - 50 Hz
Fan motor	50 Hz - 3 kW	50 Hz - 4 kW	50 Hz - 5,5 kW	50 Hz - 7,5 kW
Acoustic level	<70 dB(A)	<71 dB(A)	<74 dB(A)	<75,5 dB(A)
CE certificate	0085CL0215	0085CL0215	0085CL0215	0085CL0215
Burner body	3750226	3750227	3750228	3750229
Combustion head	KN	3750253	3750256	3750256
	KM	3750254	3750257	3750257
	KL	3750255	3750258	3750258

GAS TRAINS

DUNGS

Model	Code
GT-d552-1"1/2 (*)	3750504
GT-d553-2" (*)	3750505
GT-d554-65	3750506
GT-d555-80	3750507
GT-d556-100	3750508

SIEMENS

Model	Code
GT-s551-1"1/2	3750519
GT-s552-2"	3750520
GT-s553-65	3750521
GT-s554-80	3750522
GT-s555-100	3750523
GT-s556-125	3750524

FILTERS

Model	Code
FG-Rp1"1/2	3750543
FG-Rp2"	3750544
FG-DN65	3750545
FG-DN80	3750546
FG-DN100	3750547
FG-DN125	3750548

*: integrated filter

 **Pressure drops graphs:** see following pages
Dimensions of gas trains and gas filters: see pag.198



DIMENSIONS (mm)

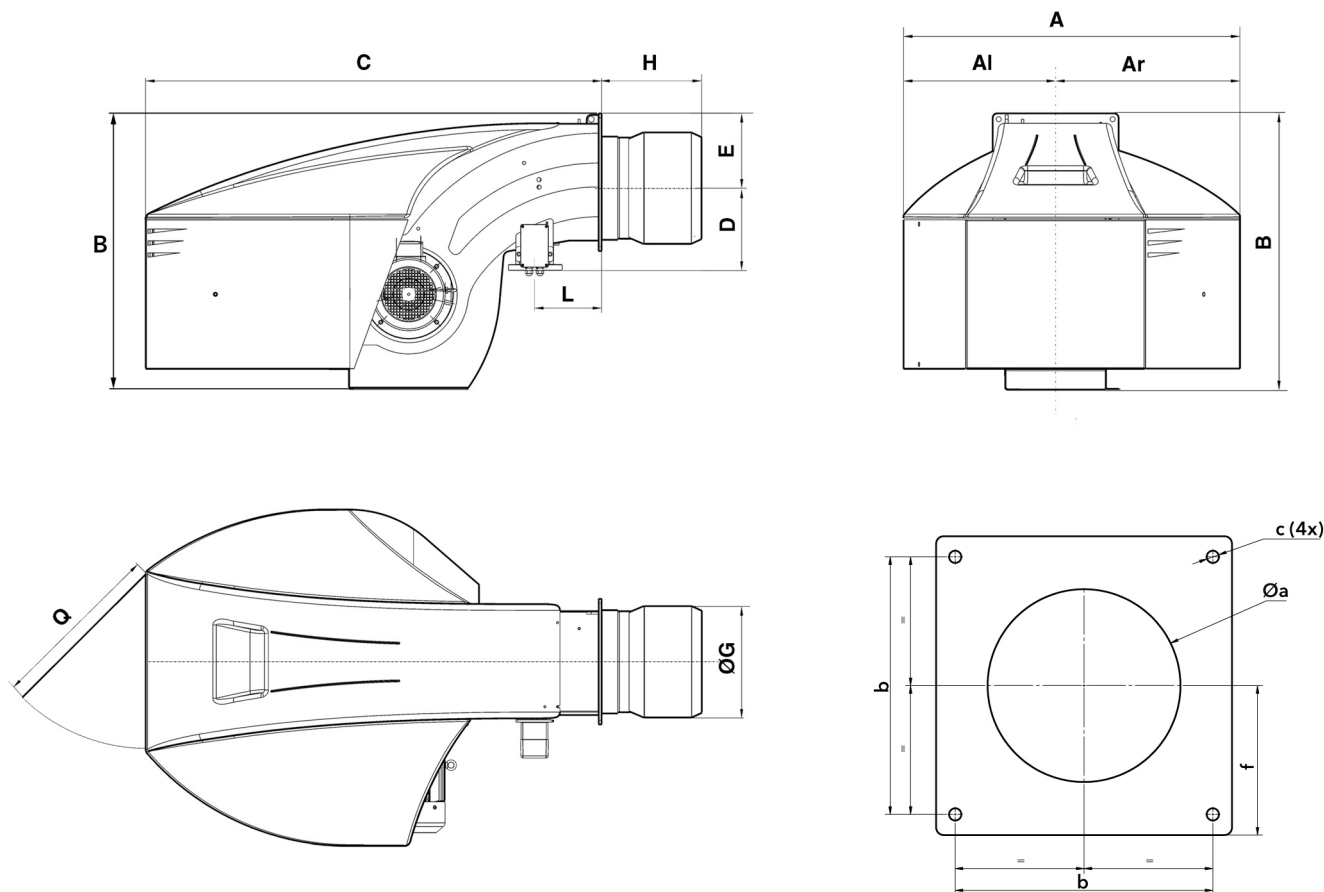

Model	A	Al	Ar	B	C	D	E	ØG	H			L	Q	Øa	b	c	f
									KN	KM	KL						
N6	990	479	510	837	1361	245	225	320	330	450	570	215	600	330-340	340	M16	200
N7	1128	511	618	961	1529	276	255	370	375	505	635	225	600	380-400	400	M16	235

PACKAGING

- The burner is delivered in 2 packages containing:
- burner body with mounted combustion head, boiler fixing accessories and technical documentation;
 - gas train and filter.

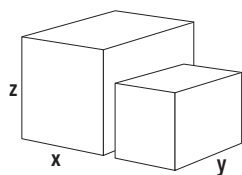

Models		Dimensions (mm)			Gross weight (kg)
		X	Y	Z	
N6.2400 G-R	KN	1691	990	837	280
	KM	1811	990	837	280
	KL	1931	990	837	280
N6.2900 G-R	KN	1691	990	837	290
	KM	1811	990	837	290
	KL	1931	990	837	290
N7.3600 G-R	KN	1904	1128	961	320
	KM	2034	1128	961	320
	KL	2164	1128	961	320
N7.4500 G-R	KN	1904	1128	961	330
	KM	2034	1128	961	330
	KL	2164	1128	961	330

PRESSURE LOSSES (BURNER HEAD + GAS TRAIN)

N6.2400 G-R

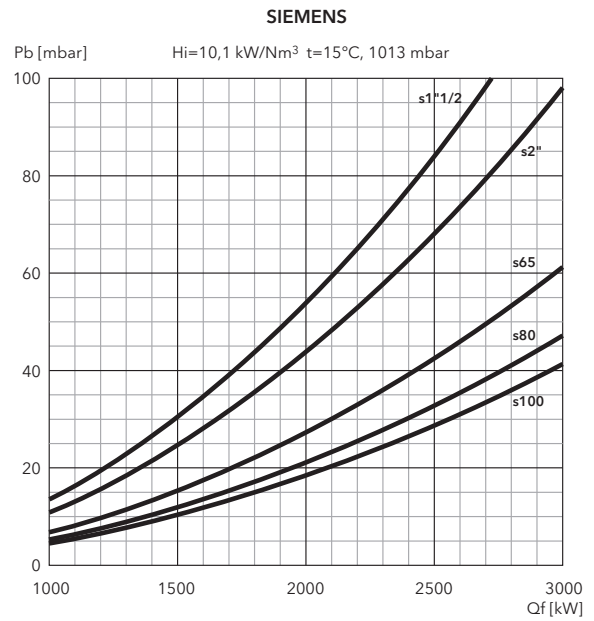
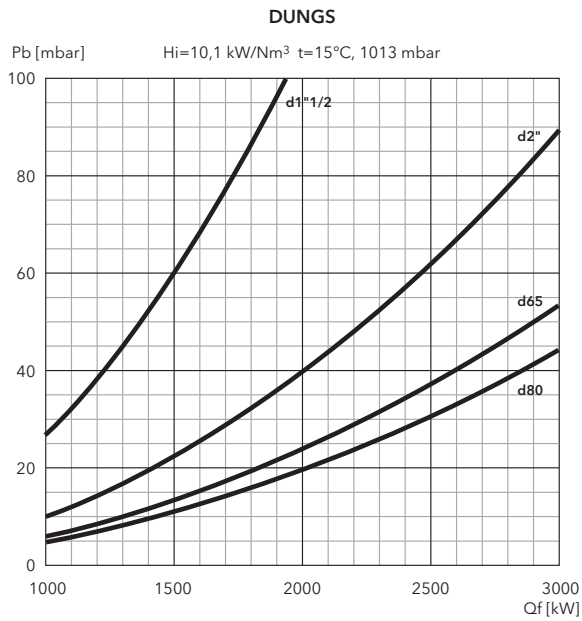

N6.2900 G-R

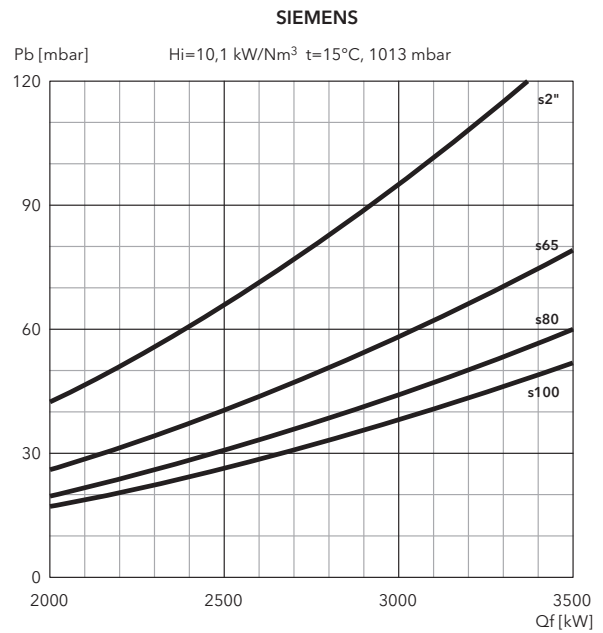
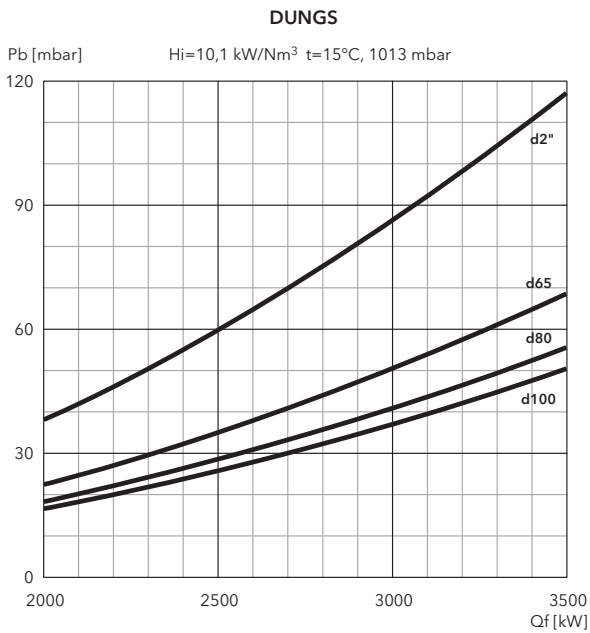

FILTERS

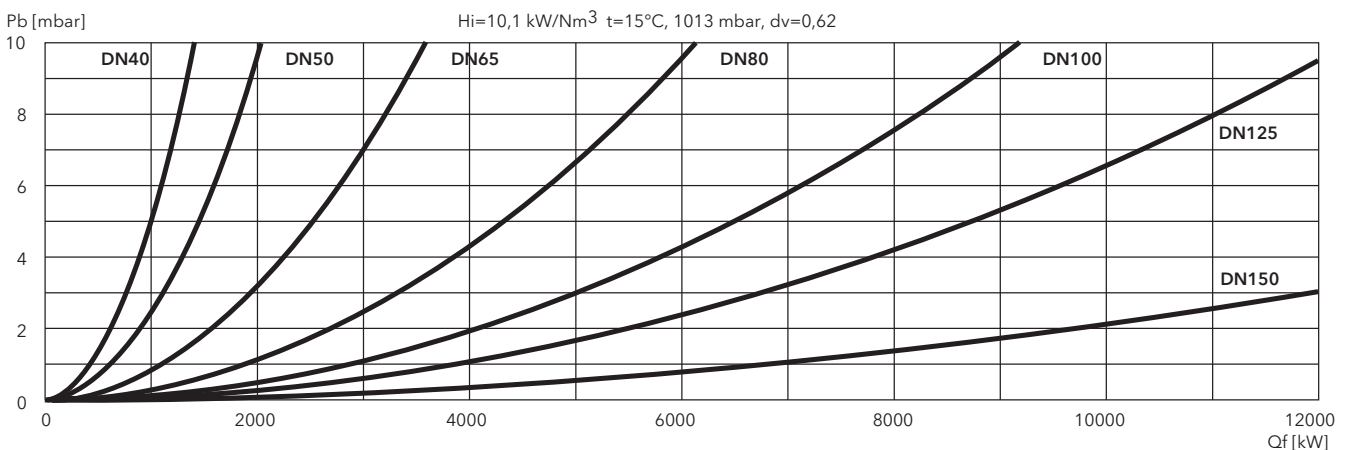

PRESSURE LOSSES (BURNER HEAD + GAS TRAIN)

N7.3600 G-R

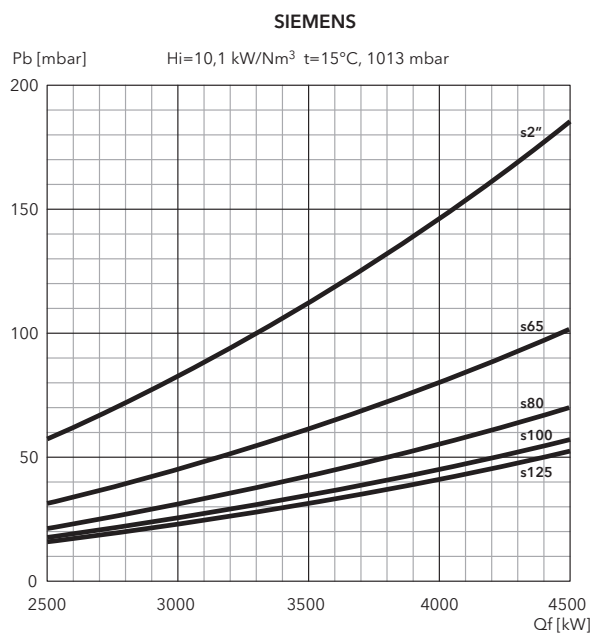
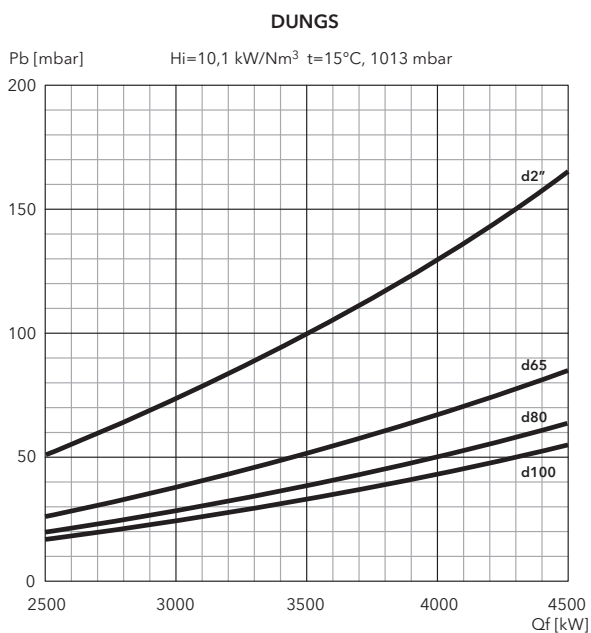

N7.4500 G-R

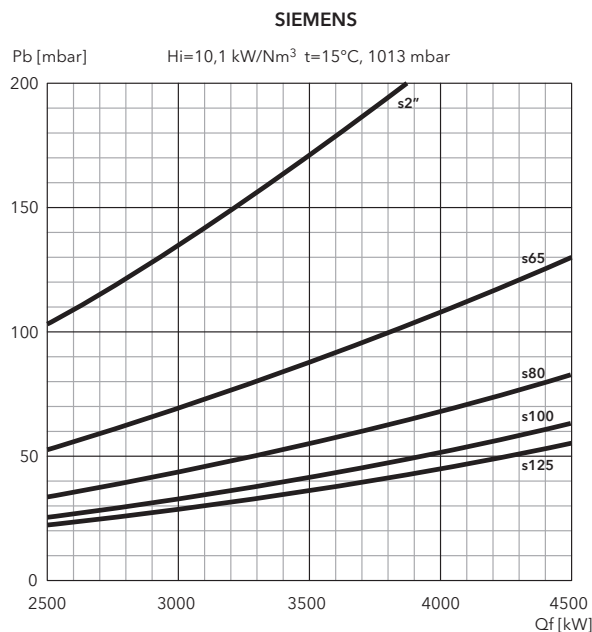
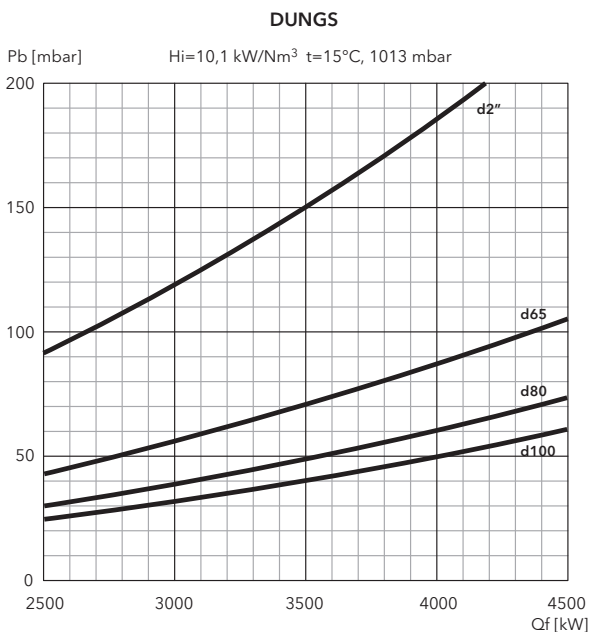

FILTERS

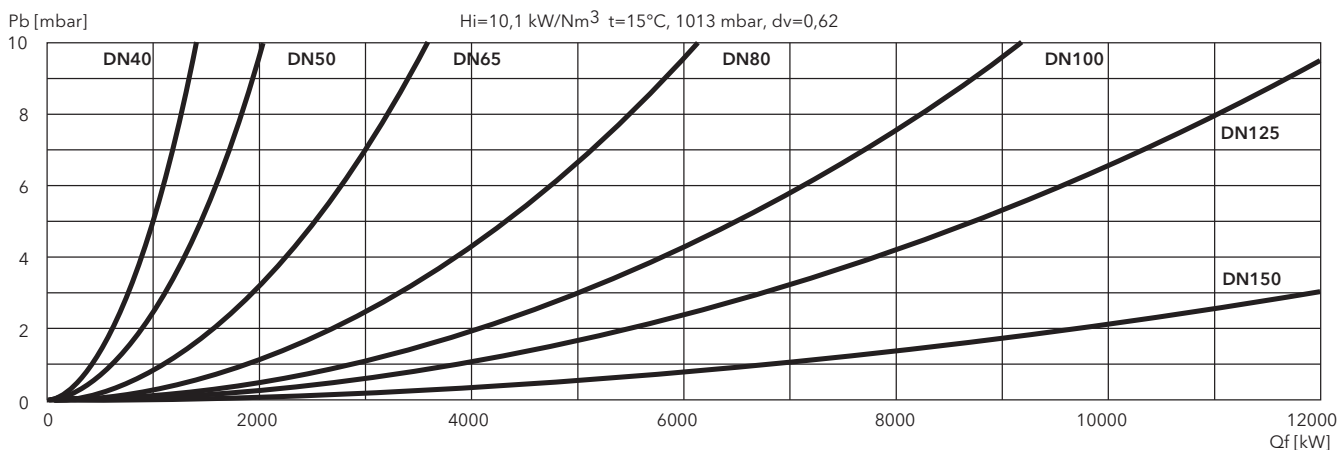

N6 G-V, N7 G-V

390 ... 5000 kW

2 stage progressive/modulating pneumatic

- **Fuels:** natural gas, low calorific value 6,99 ... 11,39 kWh/m³;
LPG, low calorific value 25,89 kWh/m³
- **Emission class:** Low NOx class 2 (<120 mg/kWh) according to EN676
- **Modulating ratio:** 1:4
- **Electrical power supply:** single-phase 230 V - 50 Hz
- **Protection level:** IP 41



TECHNICAL DATA

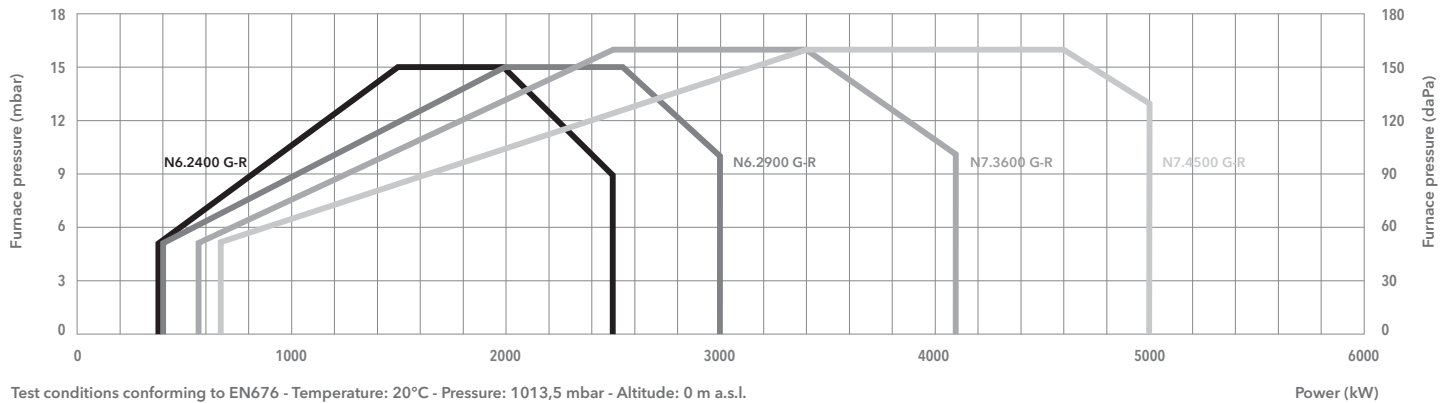

	N6.2400 G-V	N6.2900 G-V	N7.3600 G-V	N7.4500 G-V
Operating range	390 - 2500 kW	400 - 3000 kW	580 - 4100 kW	680 - 5000 kW
Gas pressure	50 - 500 mbar	50 - 500 mbar	50 - 500 mbar	50 - 500 mbar
Control box / flame detector	LFL 1.333 / Ionisation	LFL 1.333 / Ionisation	LFL 1.333 / Ionisation	LFL 1.333 / Ionisation
Auxiliary voltage	1NPE AC 230 V - 50 Hz TN-S	1NPE AC 230 V - 50 Hz TN-S	1NPE AC 230 V - 50 Hz TN-S	1NPE AC 230 V - 50 Hz TN-S
Power supply	3PE AC 400 V - 50 Hz	3PE AC 400 V - 50 Hz	3PE AC 400 V - 50 Hz	3PE AC 400 V - 50 Hz
Fan motor	50 Hz - 3 kW	50 Hz - 4 kW	50 Hz - 5,5 kW	50 Hz - 7,5 kW
Acoustic level	<70 dB(A)	<71 dB(A)	<74 dB(A)	<75 dB(A)
CE certificate	0085CL0215	0085CL0215	0085CL0215	0085CL0215
Burner body	3750218	3750219	3750220	3750221
Combustion head	KN 3750238	3750238	3750241	3750241
	KM 3750239	3750239	3750242	3750242
	KL 3750240	3750240	3750243	3750243

GAS TRAINS

SIEMENS

Model	Code
GT-s351-1"1/2	3750531
GT-s352-2"	3750532
GT-s353-65	3750533
GT-s354-80	3750534
GT-s355-100	3750535
GT-s356-125	3750536

FILTERS

Model	Code
FG-Rp1"1/2	3750543
FG-Rp2"	3750544
FG-DN65	3750545
FG-DN80	3750546
FG-DN100	3750547
FG-DN125	3750548

Pressure drops graphs: see following pages
Dimensions of gas trains and gas filters: see pag. 199



DIMENSIONS (mm)

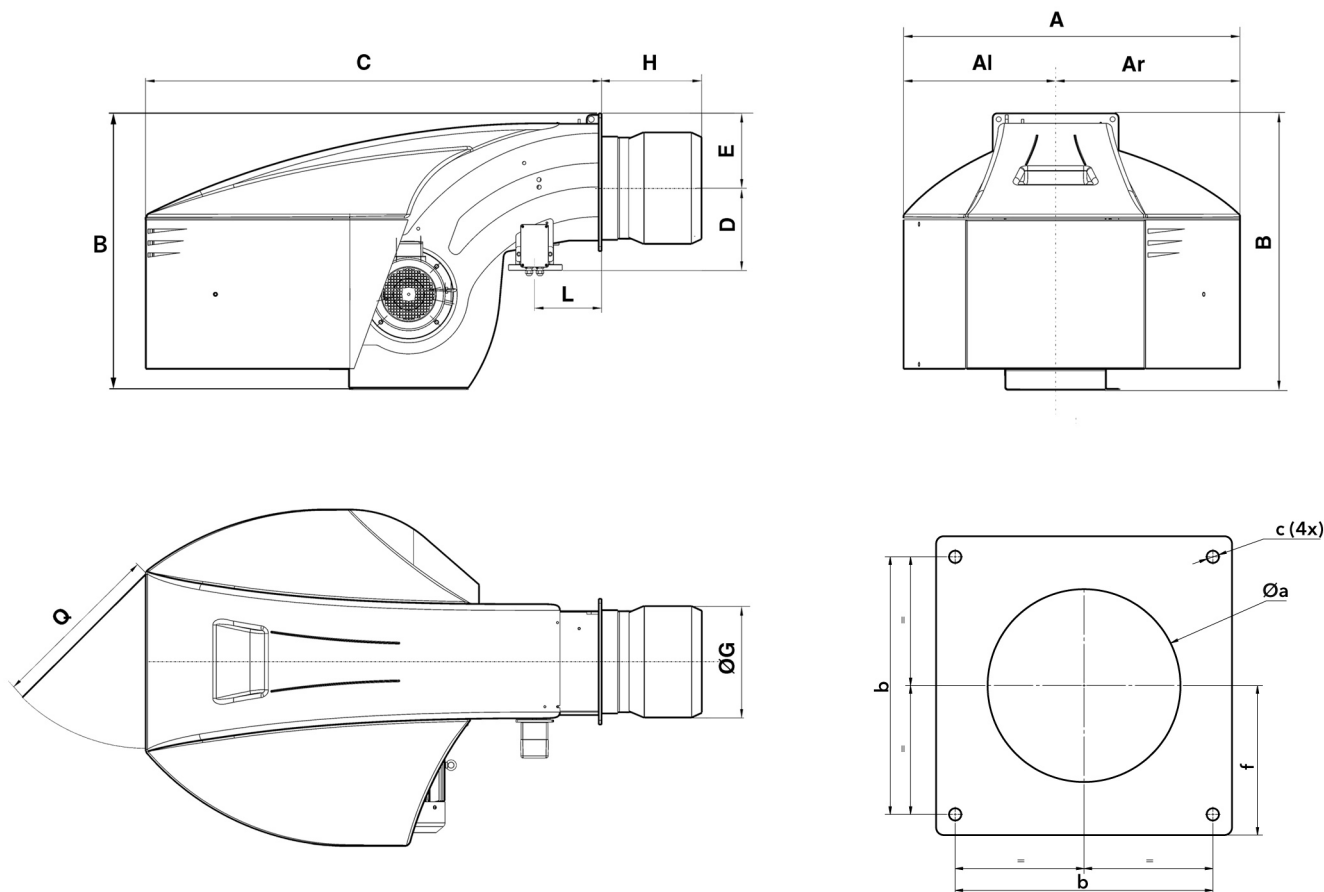

Model	A	Al	Ar	B	C	D	E	ØG	H			L	Q	Øa	b	c	f
									KN	KM	KL						
N6	990	479	510	837	1361	245	225	320	330	450	570	215	600	330-340	340	M16	200
N7	1128	511	618	961	1529	276	255	370	375	505	635	225	600	380-400	400	M16	235

PACKAGING

- The burner is delivered in 2 packages containing:
- burner body with mounted combustion head, boiler fixing accessories and technical documentation;
 - gas train and filter.

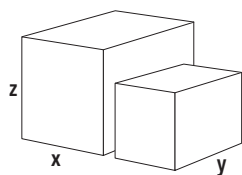

Models		Dimensions (mm)			Gross weight (kg)
		X	Y	Z	
N6.2400 G-V	KN	1691	990	837	280
	KM	1811	990	837	280
	KL	1931	990	837	280
N6.2900 G-V	KN	1691	990	837	290
	KM	1811	990	837	290
	KL	1931	990	837	290
N7.3600 G-V	KN	1904	1128	961	320
	KM	2034	1128	961	320
	KL	2164	1128	961	320
N7.4500 G-V	KN	1904	1128	961	330
	KM	2034	1128	961	330
	KL	2164	1128	961	330

PRESSURE LOSSES (BURNER HEAD + GAS TRAIN)

N6.2400 G-V

SIEMENS

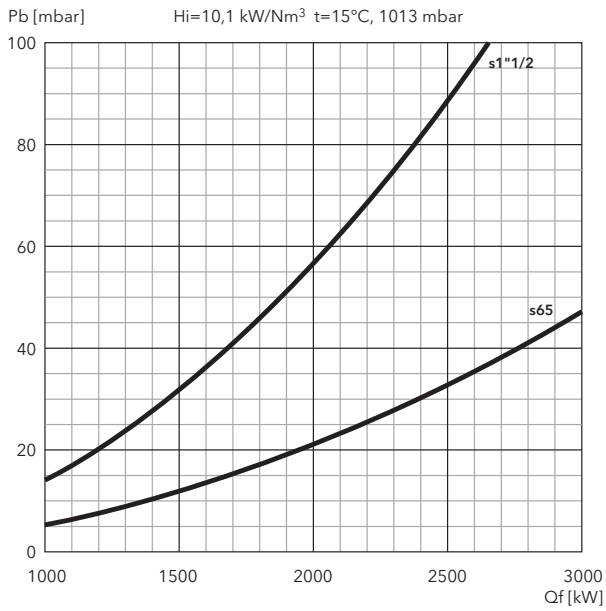

N6.2900 G-V

SIEMENS

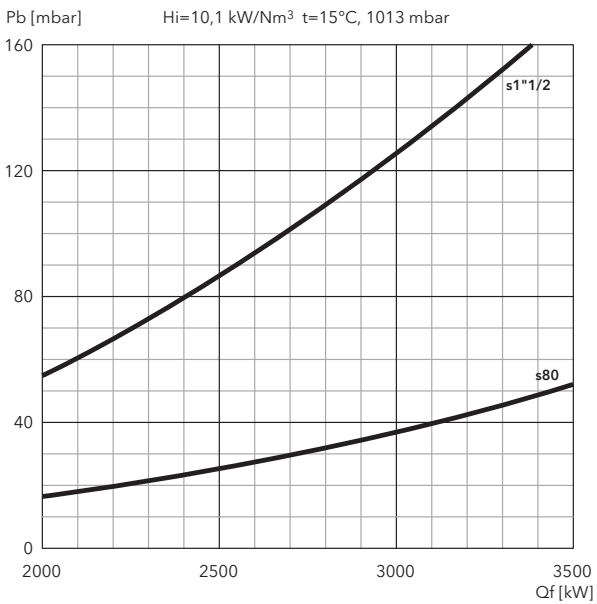

FILTERS

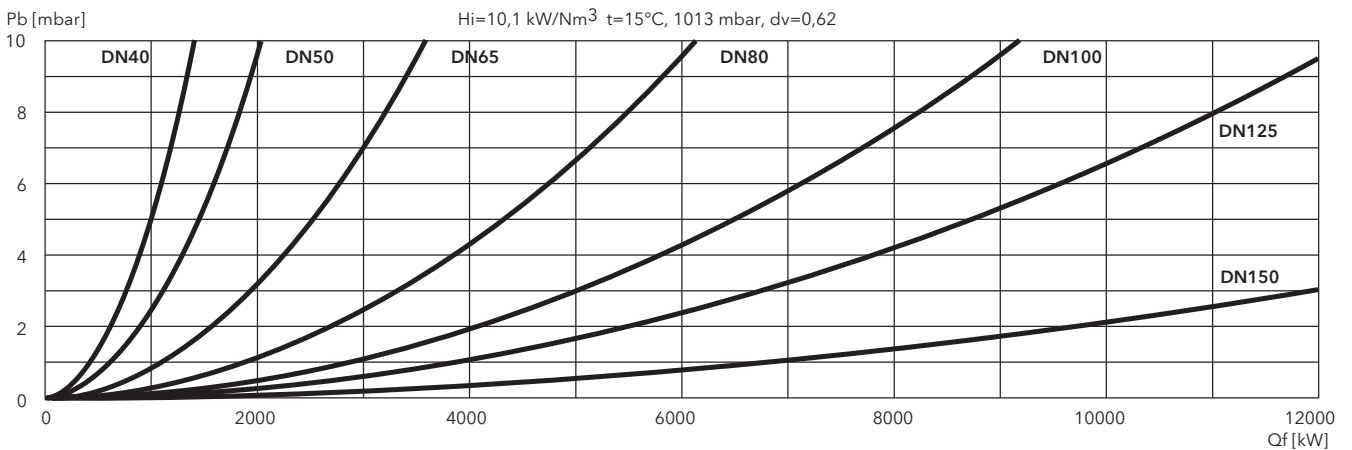

PRESSURE LOSSES (BURNER HEAD + GAS TRAIN)

N7.3600 G-V

SIEMENS

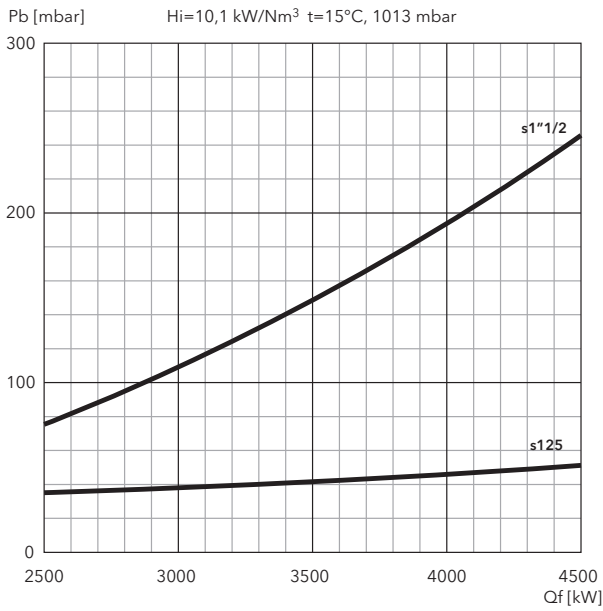

N7.4500 G-V

SIEMENS

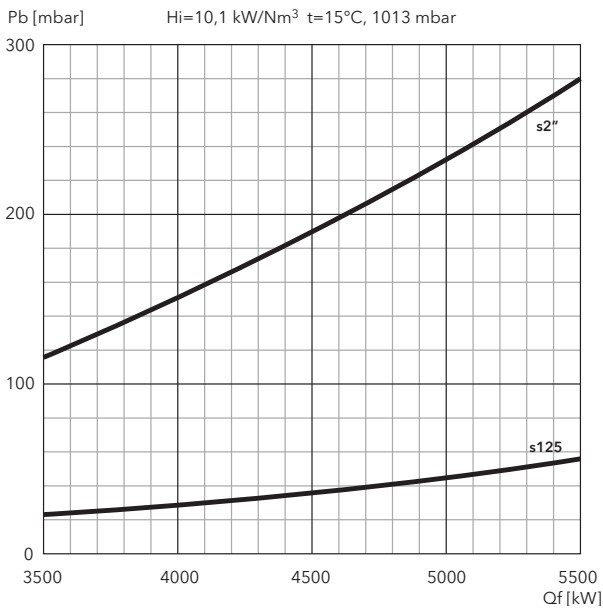

FILTERS

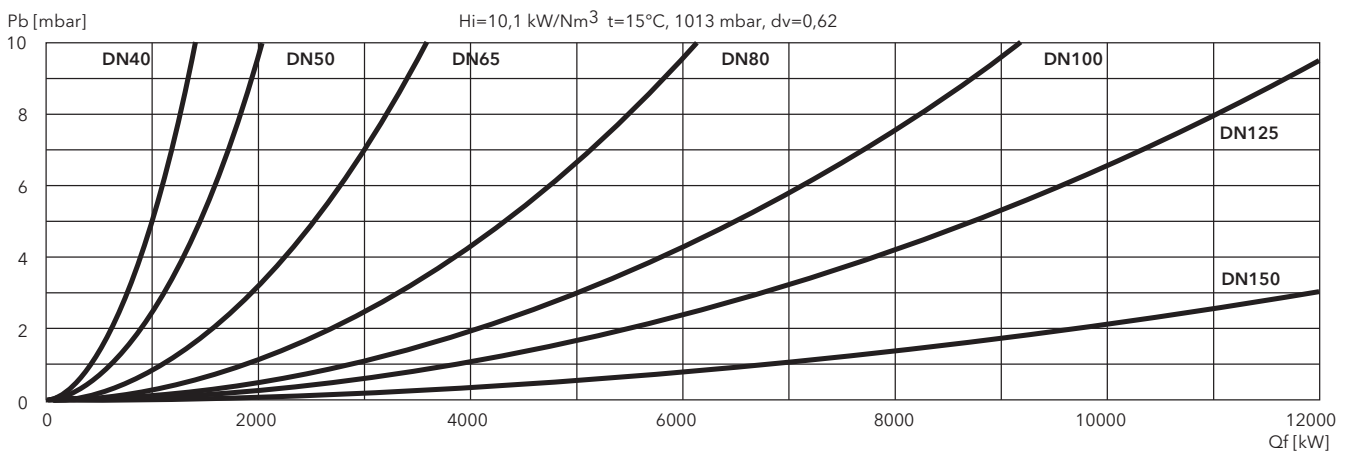

N6 G-VF3, N7 G-VF3

340 ... 4200 kW
2 stage progressive/modulating pneumatic (Low NOx class 3)

- **Fuels:** natural gas, low calorific value 6,99 ... 11,39 kWh/m³;
LPG, low calorific value 25,89 kWh/m³
- **Emission class:** Low NOx class 2 (<120 mg/kWh) according to EN676
- **Modulating ratio:** 1:5
- **Electrical power supply:** single-phase 230 V - 50 Hz
- **Protection level:** IP 41



TECHNICAL DATA

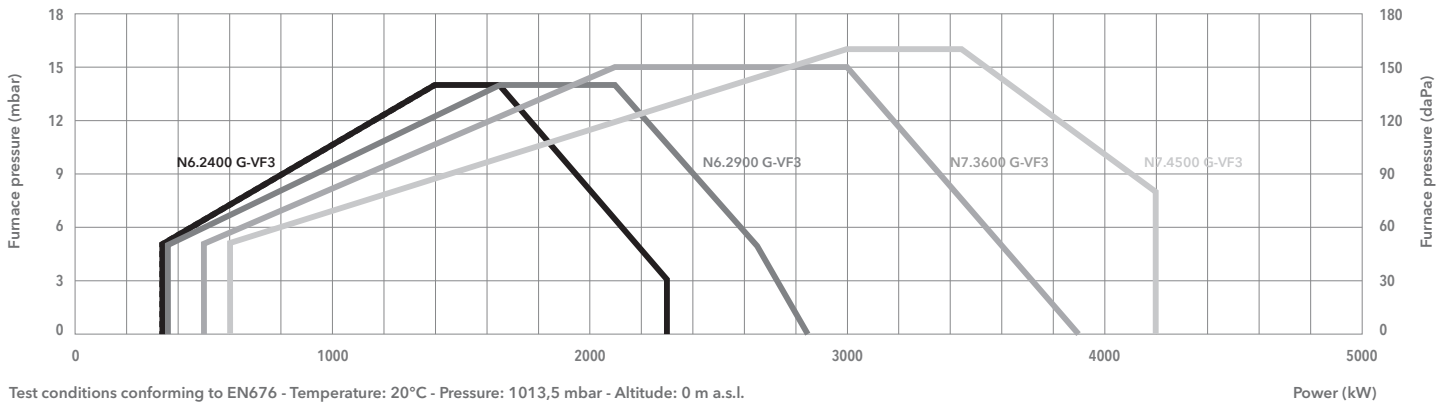

Test conditions conforming to EN676 - Temperature: 20°C - Pressure: 1013,5 mbar - Altitude: 0 m a.s.l.

	N6.2400 G-VF3	N6.2900 G-VF3	N7.3600 G-VF3	N7.4500 G-VF3
Operating range	340 - 2300 kW	360 - 2850 kW	500 - 3900 kW	600 - 4200 kW
Gas pressure	50 - 500 mbar	50 - 500 mbar	50 - 500 mbar	50 - 500 mbar
Control box / flame detector	LFL 1.333 / QRA2	LFL 1.333 / QRA2	LFL 1.333 / QRA2	LFL 1.333 / QRA2
Auxiliary voltage	1NPE AC 230 V - 50 Hz TN-S	1NPE AC 230 V - 50 Hz TN-S	1NPE AC 230 V - 50 Hz TN-S	1NPE AC 230 V - 50 Hz TN-S
Power supply	3PE AC 400 V - 50 Hz	3PE AC 400 V - 50 Hz	3PE AC 400 V - 50 Hz	3PE AC 400 V - 50 Hz
Fan motor	50 Hz - 3 kW	50 Hz - 4 kW	50 Hz - 7,5 kW	50 Hz - 7,5 kW
Acoustic level	<70 dB(A)	<71 dB(A)	<74 dB(A)	<75 dB(A)
CE certificate	0085CL0215	0085CL0215	0085CL0215	0085CL0215
Burner body	3750222	3750223	3750224	3750225
Combustion head	KN 3750244	3750244	3750247	3750250
	KM 3750245	3750245	3750248	3750251
	KL 3750246	3750246	3750249	3750252

GAS TRAINS

SIEMENS

Model	Code
GT-s351-1"1/2	3750531
GT-s352-2"	3750532
GT-s353-65	3750533
GT-s354-80	3750534

FILTERS

Model	Code
FG-Rp1"1/2	3750543
FG-Rp2"	3750544
FG-DN65	3750545
FG-DN80	3750546
FG-DN100	3750547
FG-DN125	3750548

Pressure drops graphs: see following pages
Dimensions of gas trains and gas filters: see pag. 199



DIMENSIONS (mm)

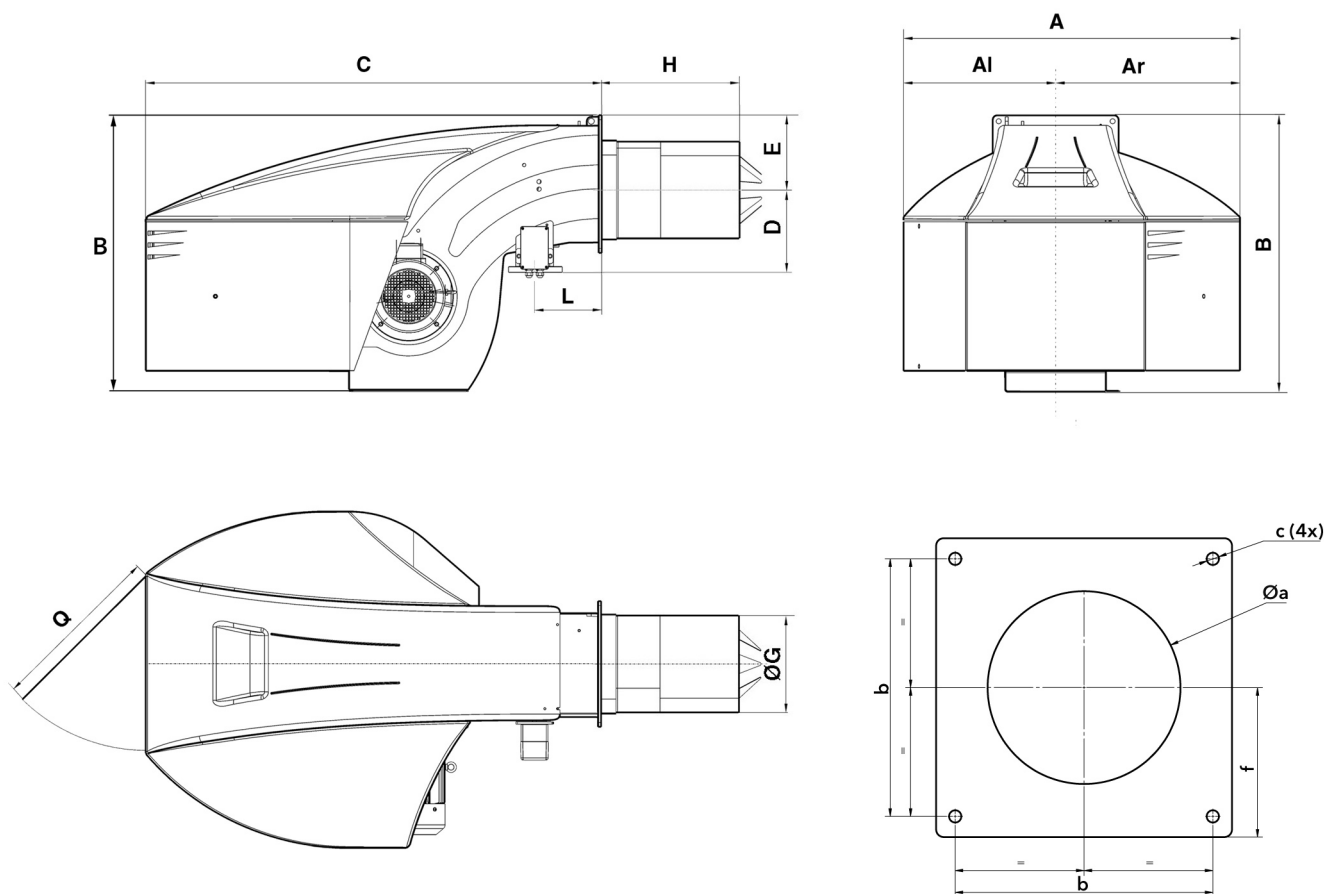

Model	A	Al	Ar	B	C	D	E	ØG	H			L	Q	Øa	b	c	f
									KN	KM	KL						
N6	990	479	510	837	1361	245	225	264	400	520	640	215	600	330-340	340	M16	200
N7	1128	511	618	961	1529	276	255	326	420	550	680	225	600	380-400	400	M16	235

PACKAGING

- The burner is delivered in 2 packages containing:
- burner body with mounted combustion head, boiler fixing accessories and technical documentation;
 - gas train and filter.

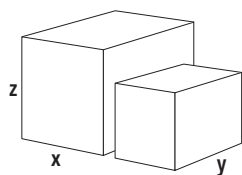

Models		Dimensions (mm)			Gross weight (kg)
		X	Y	Z	
N6.2400 G-VF3	KN	1861	990	837	280
	KM	1981	990	837	280
	KL	2101	990	837	280
N6.2900 G-VF3	KN	1861	990	837	290
	KM	1981	990	837	290
	KL	2101	990	837	290
N7.3600 G-VF3	KN	2049	1128	961	320
	KM	2179	1128	961	320
	KL	2309	1128	961	320
N7.4500 G-VF3	KN	2049	1128	961	330
	KM	2179	1128	961	330
	KL	2309	1128	961	330

PRESSURE LOSSES (BURNER HEAD + GAS TRAIN)

N6.2400 G-VF3

SIEMENS

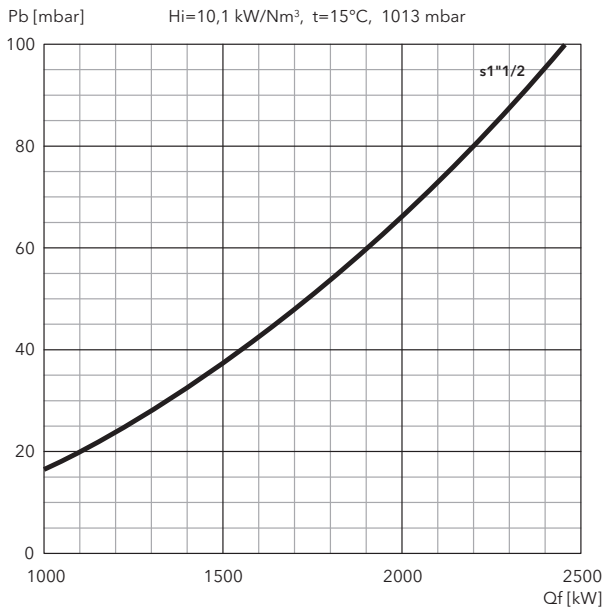

N6.2900 G-VF3

SIEMENS

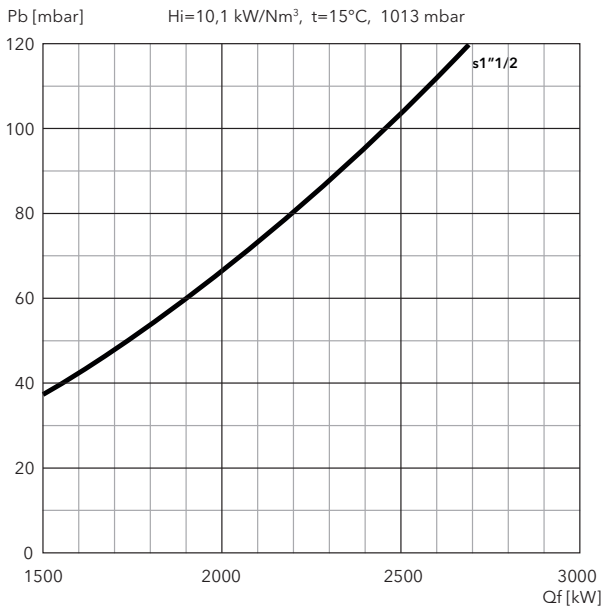

FILTERS

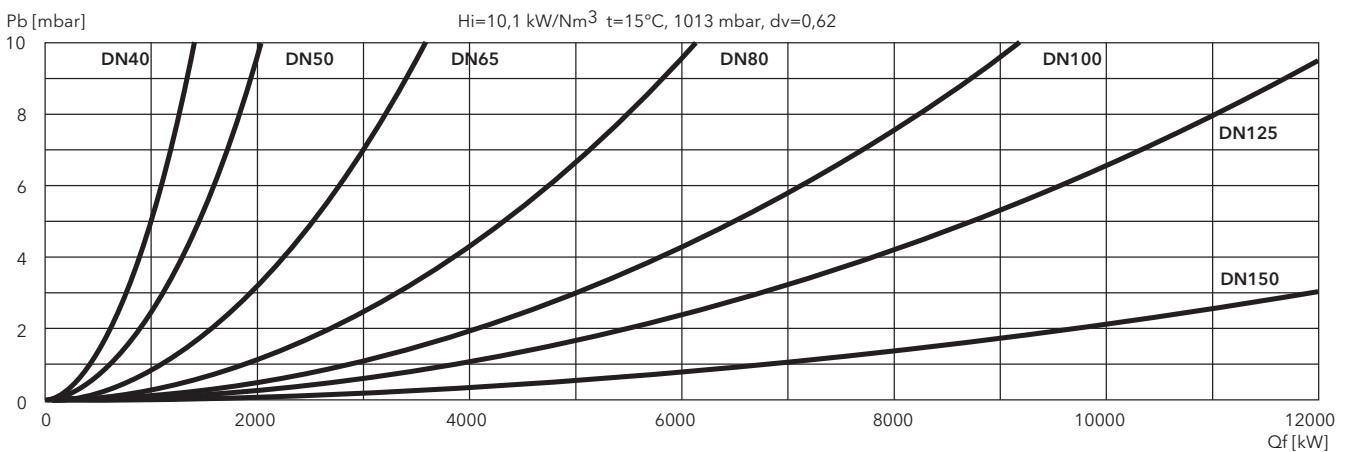

PRESSURE LOSSES (BURNER HEAD + GAS TRAIN)

N7.3600 G-VF3

SIEMENS

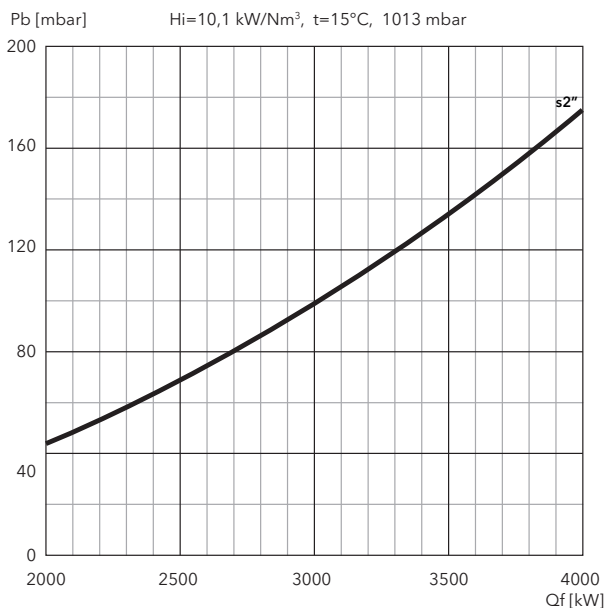

N7.4500 G-VF3

SIEMENS

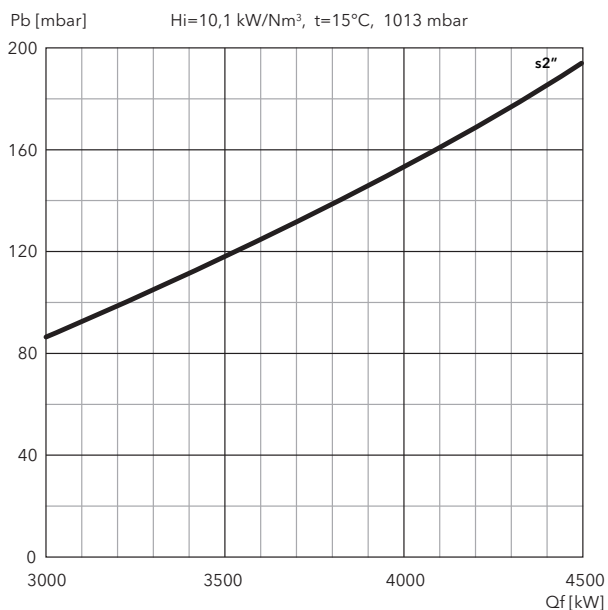

FILTERS

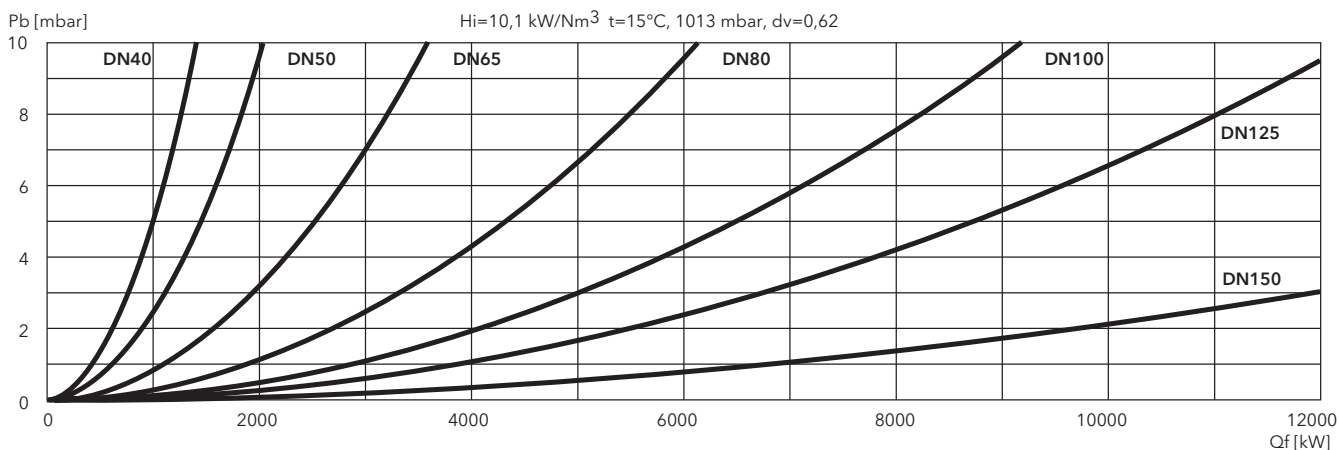

N6 G-E, N7 G-E

390 ... 5000 kW

2 stage progressive/modulating electronic

- **Fuels:** natural gas, low calorific value 6,99 ... 11,39 kWh/m³;
LPG, low calorific value 25,89 kWh/m³
- **Emission class:** Low NOx class 2 (<120 mg/kWh) according to EN676
- **Modulating ratio:** 1:4
- **Electrical power supply:** single-phase 230 V - 50 Hz
- **Protection level:** IP 41



TECHNICAL DATA

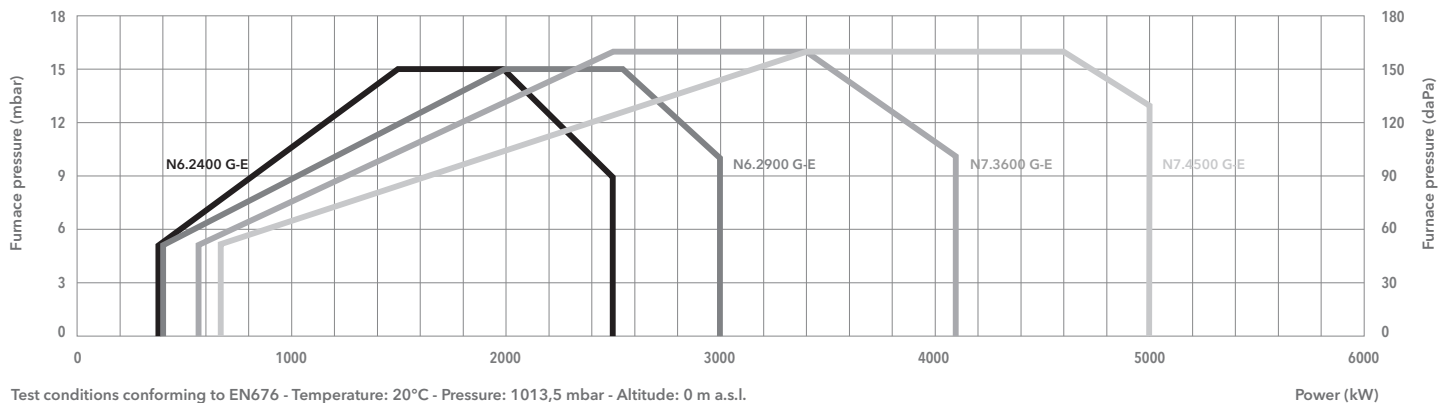

Test conditions conforming to EN676 - Temperature: 20°C - Pressure: 1013,5 mbar - Altitude: 0 m a.s.l.

Power (kW)

	N6.2400 G-E	N6.2900 G-E	N7.3600 G-E	N7.4500 G-E
Operating range	390 - 2500 kW	400 - 3000 kW	580 - 4100 kW	680 - 5000 kW
Gas pressure	50 - 500 mbar (50 - 360 mbar for d452 and d453 gas train)		50 - 500 mbar (50 - 360 mbar for d452 and d453 gas train)	
Control box / flame detector	BT300 / Ionisation		BT300 / Ionisation	
Auxiliary voltage	1NPE AC 230 V - 50 Hz TN-S		1NPE AC 230 V - 50 Hz TN-S	
Power supply	3PE AC 400 V - 50 Hz		3PE AC 400 V - 50 Hz	
Fan motor	50 Hz - 3 kW	50 Hz - 4 kW	50 Hz - 5,5 kW	50 Hz - 7,5 kW
Acoustic level	<70 dB(A)	<71 dB(A)	<74 dB(A)	<75 dB(A)
CE certificate	0085CL0215		0085CL0215	
Burner body	3750558	3750571	3750584	3750597
Combustion head	KN	3750253	3750256	3750256
	KM	3750254	3750257	3750257
	KL	3750255	3750258	3750258

GAS TRAINS

DUNGS

Model	Code
GT-d452-1"1/2	3750510
GT-d453-2"	3750511
GT-d454-65	3750512
GT-d455-80	3750513
GT-d456-100	3750514

SIEMENS

Model	Code
GT-s451-1"1/2	3750525
GT-s452-2"	3750526
GT-s453-65	3750527
GT-s454-80	3750528
GT-s455-100	3750529
GT-s456-125	3750530

FILTERS

Model	Code
FG-Rp1"1/2	3750543
FG-Rp2"	3750544
FG-DN65	3750545
FG-DN80	3750546
FG-DN100	3750547
FG-DN125	3750548

 **Pressure drops graphs:** see following pages
Dimensions of gas trains and gas filters: see pag. 200

DIMENSIONS (mm)

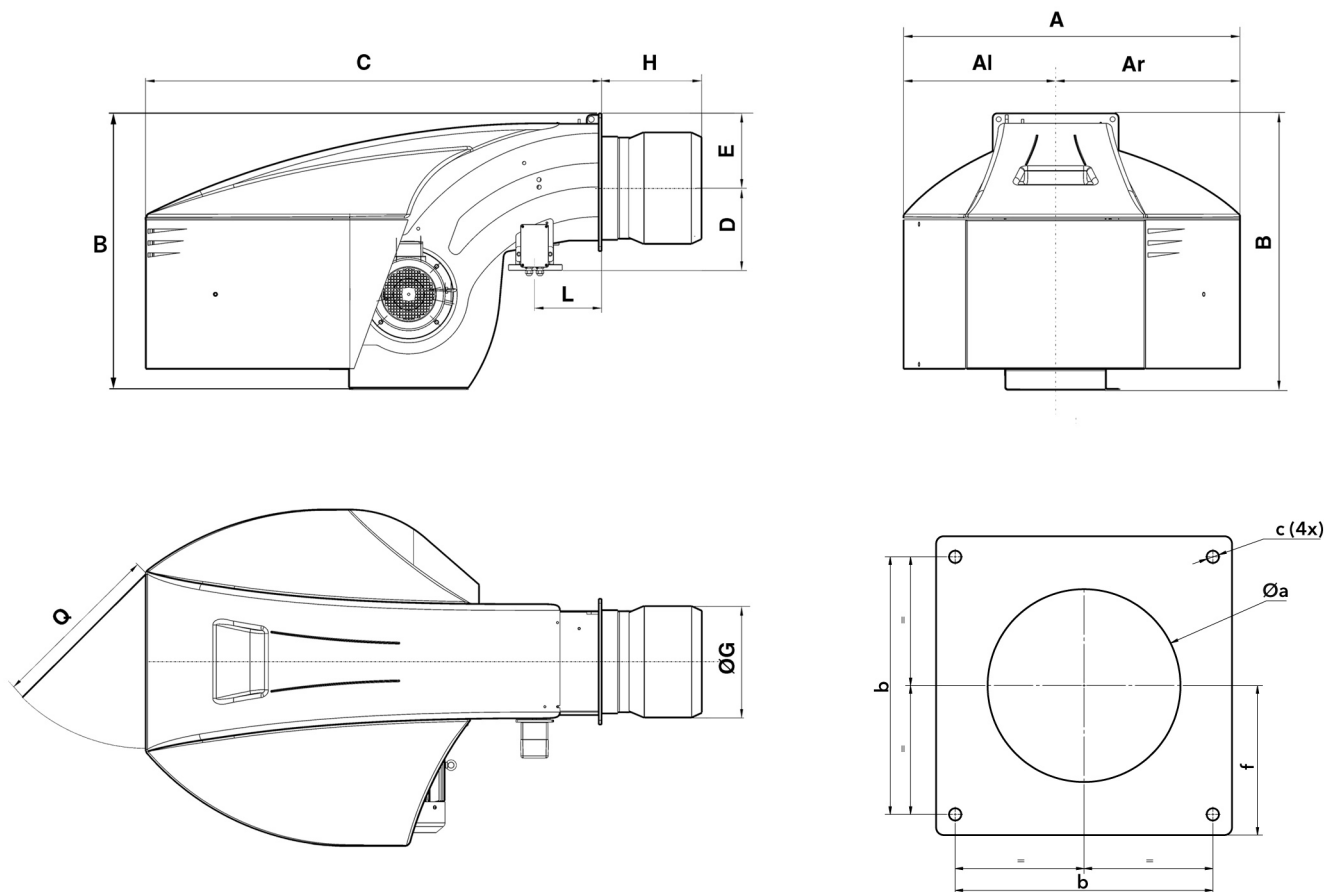

Model	A	Al	Ar	B	C	D	E	ØG	H			L	Q	Øa	b	c	f
									KN	KM	KL						
N6	990	479	510	837	1361	245	225	320	330	450	570	215	600	330-340	340	M16	200
N7	1128	511	618	961	1529	276	255	370	375	505	635	225	600	380-400	400	M16	235

PACKAGING

- The burner is delivered in 2 packages containing:
- burner body with mounted combustion head, boiler fixing accessories and technical documentation;
 - gas train and filter.

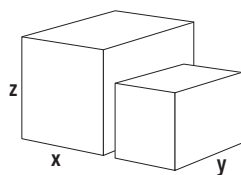

Models		Dimensions (mm)			Gross weight (kg)
		X	Y	Z	
N6.2400 G-E	KN	1691	990	837	280
	KM	1811	990	837	280
	KL	1931	990	837	280
N6.2900 G-E	KN	1691	990	837	290
	KM	1811	990	837	290
	KL	1931	990	837	290
N7.3600 G-E	KN	1904	1128	961	320
	KM	2034	1128	961	320
	KL	2164	1128	961	320
N7.4500 G-E	KN	2049	1128	961	330
	KM	2179	1128	961	330
	KL	2309	1128	961	330

PRESSURE LOSSES (BURNER HEAD + GAS TRAIN)

N6.2400 G-E

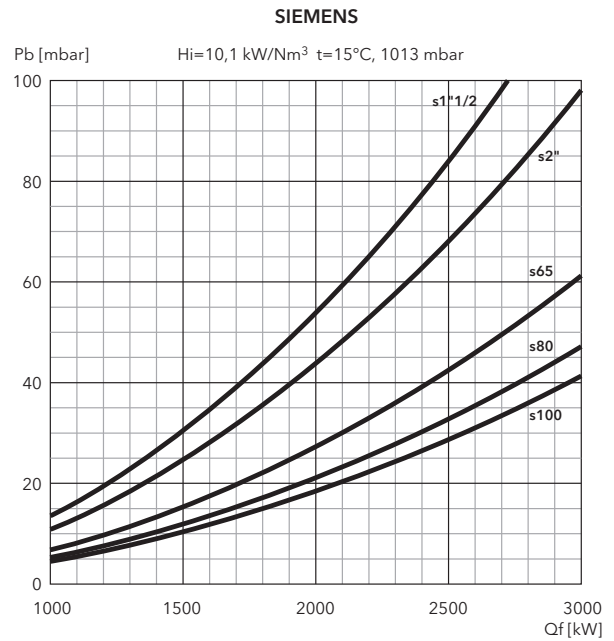
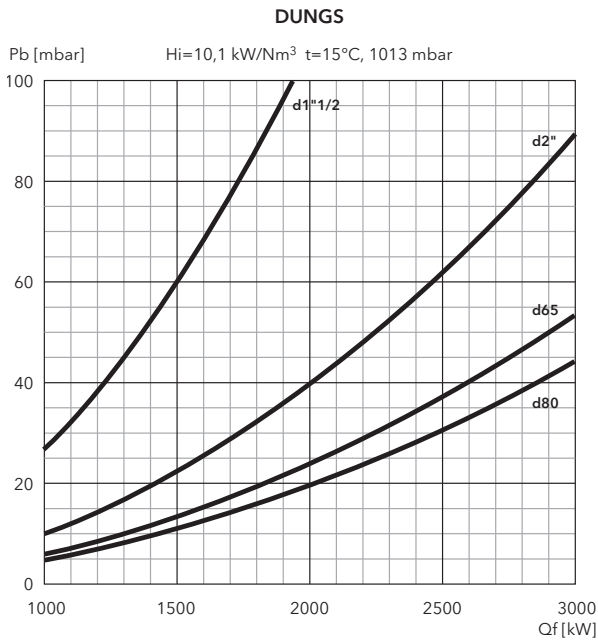

N6.2900 G-E

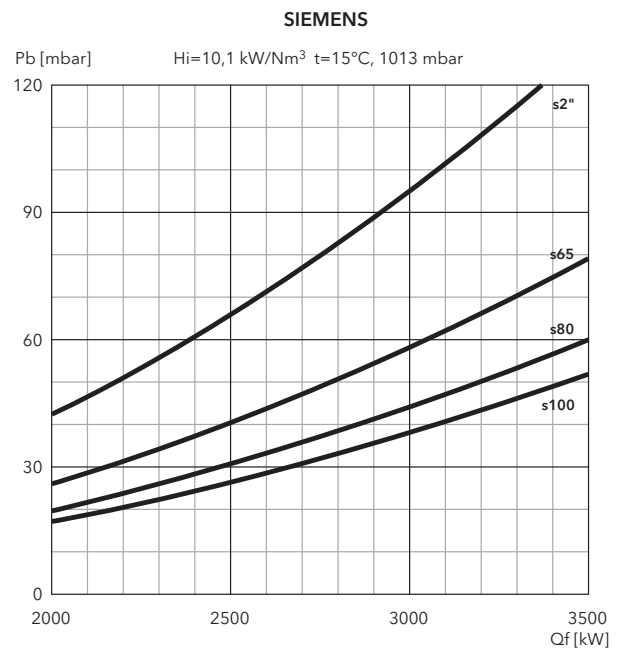
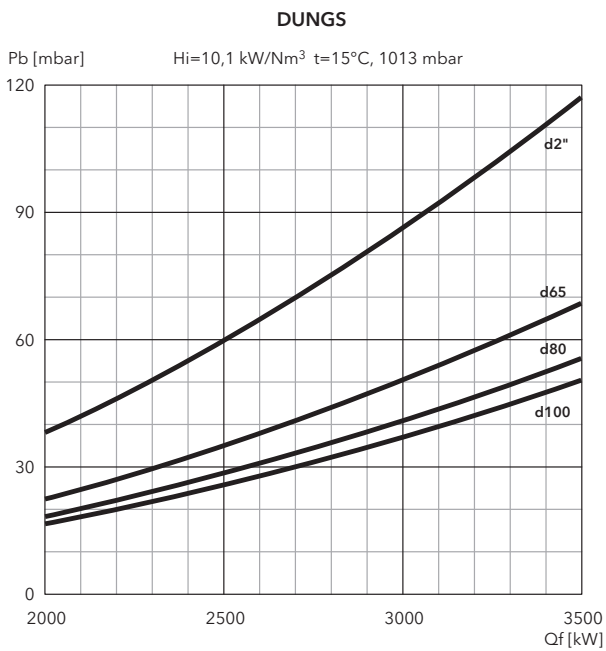

FILTERS

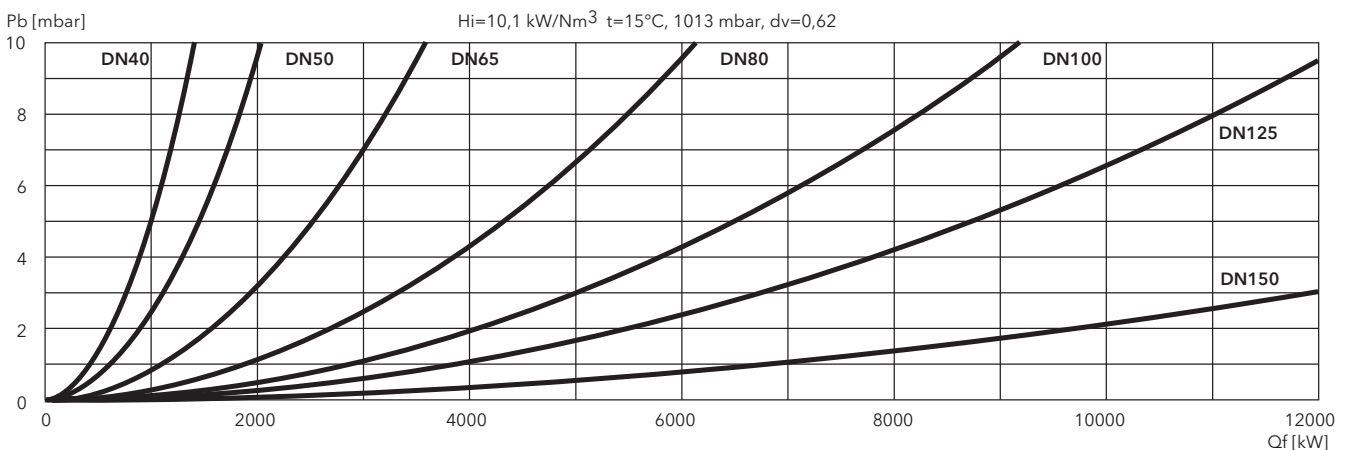

PRESSURE LOSSES (BURNER HEAD + GAS TRAIN)

N7.3600 G-E

DUNGS

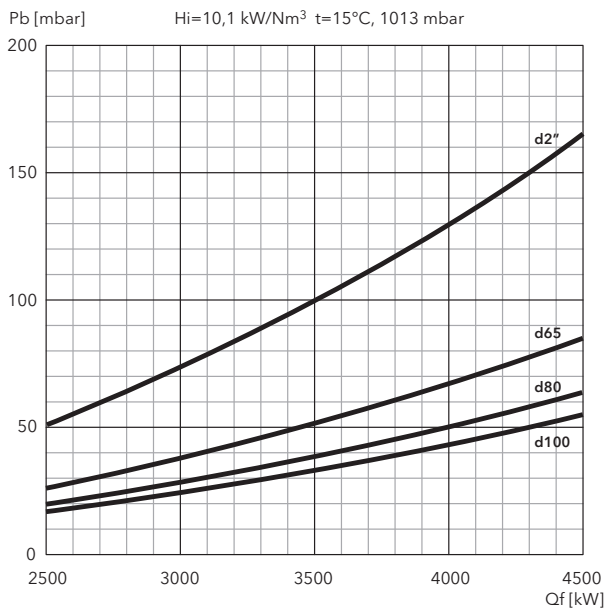

SIEMENS

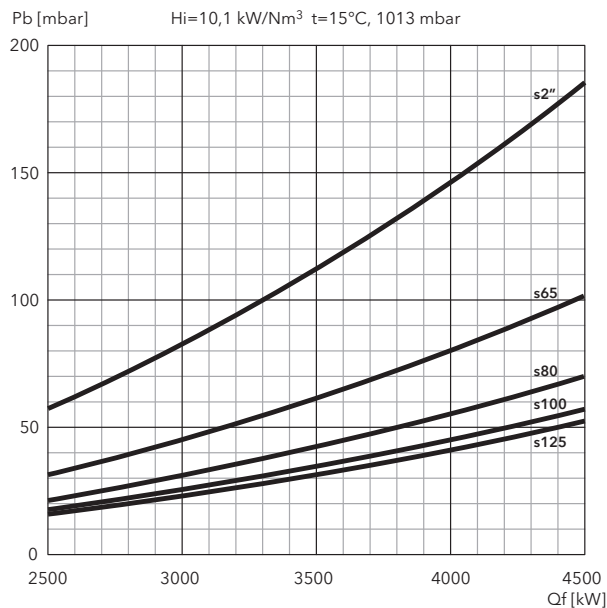

N7.4500 G-E

DUNGS

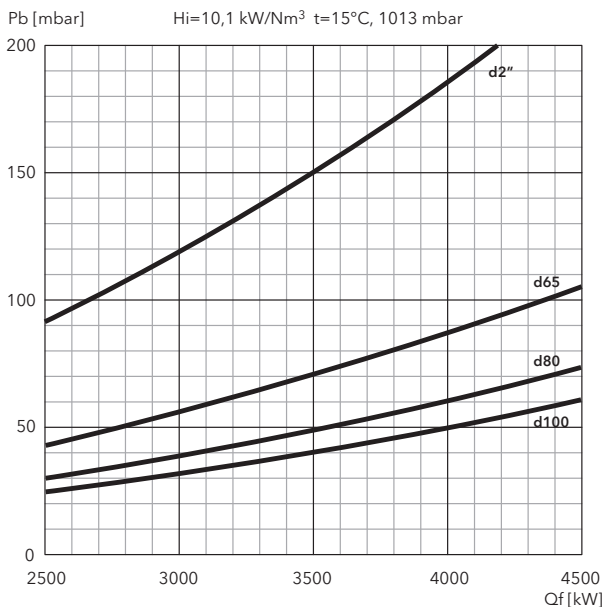

SIEMENS

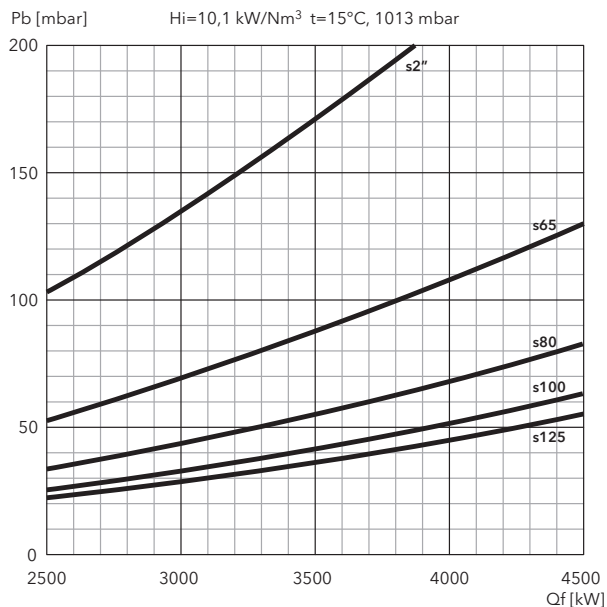

FILTERS

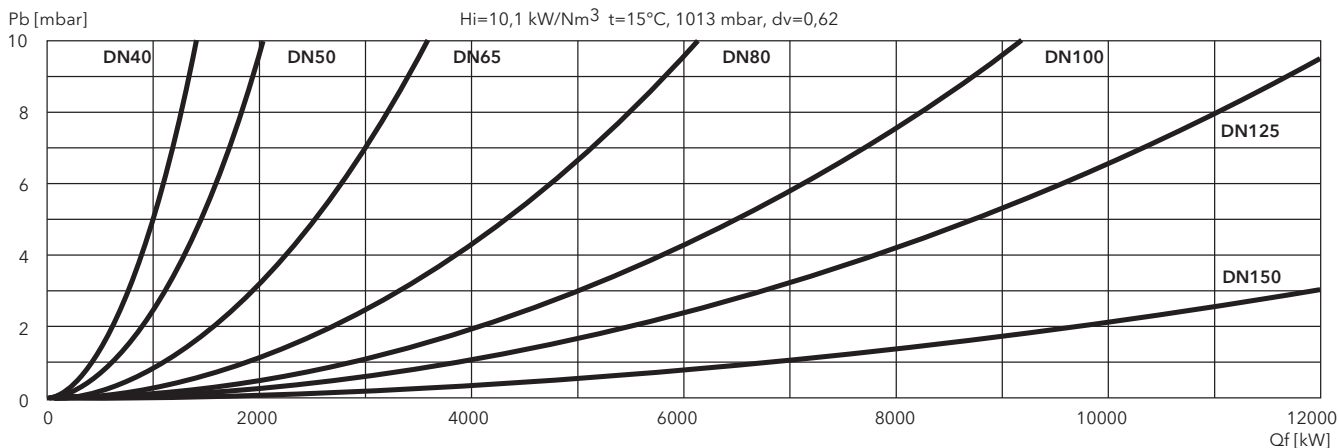

N8 G-E, N9 G-E

740 ... 11200 kW

2 stage progressive/modulating electronic

- **Fuels:** natural gas, low calorific value 6,99 ... 11,39 kWh/m³;
LPG, low calorific value 25,89 kWh/m³
- **Emission class:** Low NOx class 2 (<120 mg/kWh) according to EN676
- **Modulating ratio:** 1:10
- **Electrical power supply:** single-phase 230 V - 50 Hz
- **Protection level:** IP 41



TECHNICAL DATA

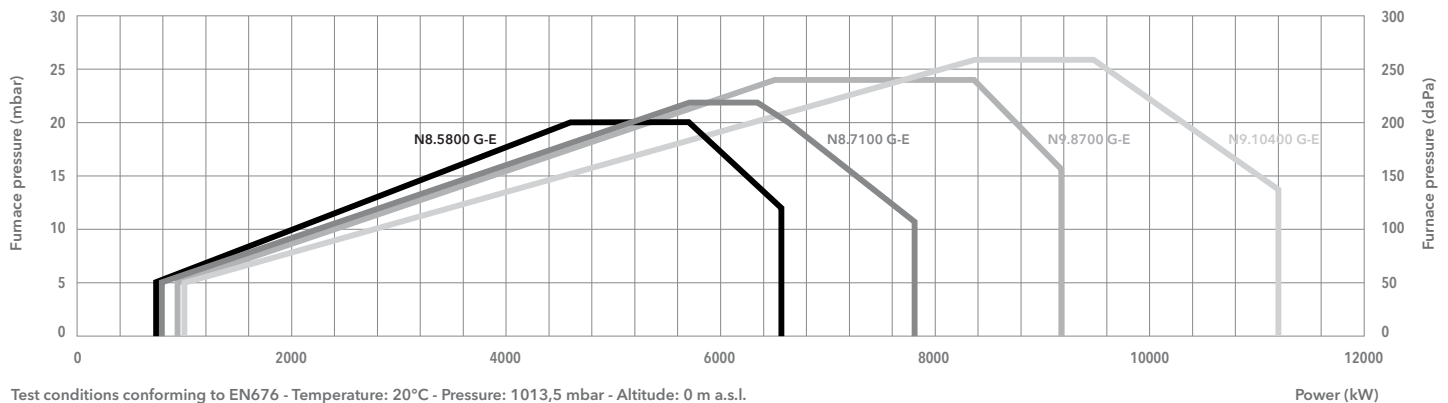

	N8.5800 G-E	N8.7100 G-E	N9.8700 G-E	N9.10400 G-E
Operating range	740 - 6570 kW	800 - 7800 kW	880 - 9200 kW	900 - 11200 kW
Gas pressure	60 - 500 mbar (60 - 360 mbar for d457 gas train)		70 - 500 mbar (70 - 360 mbar for d457 gas train)	
Control box / flame detector	BT300 / Ionisation	BT300 / Ionisation	BT300 / Ionisation	BT300 / Ionisation
Auxiliary voltage	1NPE AC 230 V - 50 Hz TN-S	1NPE AC 230 V - 50 Hz TN-S	1NPE AC 230 V - 50 Hz TN-S	1NPE AC 230 V - 50 Hz TN-S
Power supply	3PE AC 400 V - 50 Hz	3PE AC 400 V - 50 Hz	3PE AC 400 V - 50 Hz	3PE AC 400 V - 50 Hz
Fan motor	50 Hz - 11 kW	50 Hz - 15 kW	50 Hz - 18,5 kW	50 Hz - 22 kW
Acoustic level	<78 dB(A)	<78 dB(A)	<80 dB(A)	<81 dB(A)
CE certificate	0085CL0215	0085CL0215	0085CL0215	0085CL0215
Burner body	3750470	3750471	3750472	3750473
Combustion head	KN	3750478	3750480	3750481
	KM	3750482	3750484	3750485
	KL	3750486	3750487	3750489

GAS TRAINS

DUNGS

Model	Code
GT-d457-2"	3750515
GT-d458-65	3750516
GT-d459-80	3750517
GT-d460-100	3750518

SIEMENS

Model	Code
GT-s457-2"	3750537
GT-s458-65	3750538
GT-s459-80	3750539
GT-s460-100	3750540
GT-s461-125	3750541

FILTERS

Model	Code
FG-Rp2"	3750544
FG-DN65	3750545
FG-DN80	3750546
FG-DN100	3750547
FG-DN125	3750548

Pressure drops graphs: see following pages
Dimensions of gas trains and gas filters: see pag. 201

DIMENSIONS (mm)

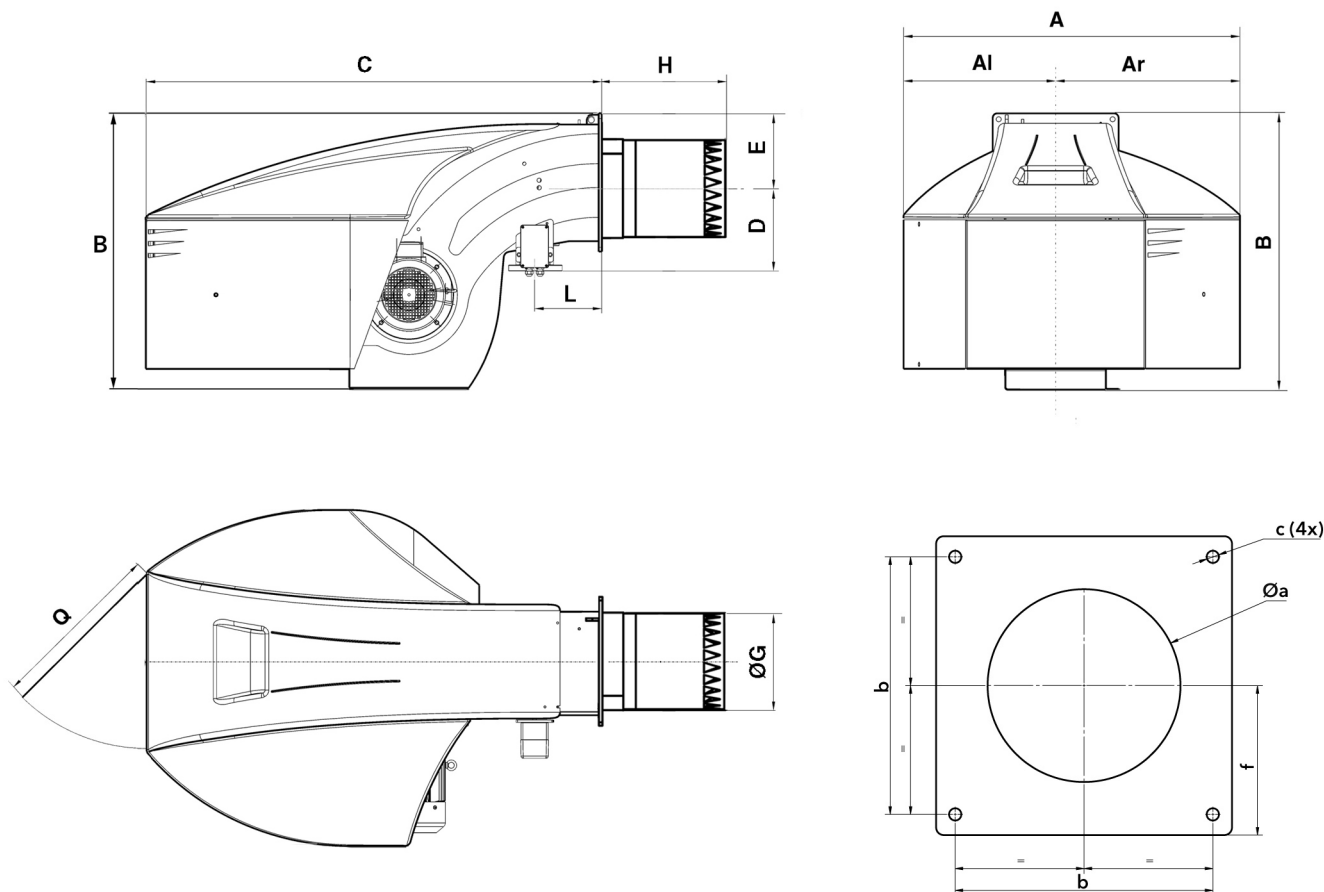

Model	A	Al	Ar	B	C	D	E	ØG	H			L	Q	Øa	b	c	f
									KN	KM	KL						
N8	1414	669	745	1231	1930	344	293	369	500	640	780	230	800	390-410	505	M20	293
N9	1414	669	745	1291	1928	369	293	431,5	550	700	850	230	800	460-480	505	M20	293

PACKAGING

- The burner is delivered in 2 packages containing:
- burner body with mounted combustion head, boiler fixing accessories and technical documentation;
 - gas train and filter.

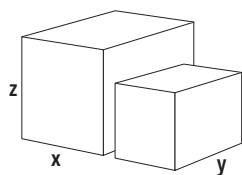

Models		Dimensions (mm)			Gross weight (kg)
		X	Y	Z	
N8.5800 G-E	KN	2430	1414	1231	527
	KM	2570	1414	1231	527
	KL	2710	1414	1231	527
N8.7100 G-E	KN	2430	1414	1231	535
	KM	2570	1414	1231	535
	KL	2710	1414	1231	535
N9.8700 G-E	KN	2430	1414	1231	527
	KM	2570	1414	1231	527
	KL	2710	1414	1231	527
N9.10400 G-E	KN	2430	1414	1231	535
	KM	2570	1414	1231	535
	KL	2710	1414	1231	535

PRESSURE LOSSES (BURNER HEAD + GAS TRAIN)

N8.5800 G-E

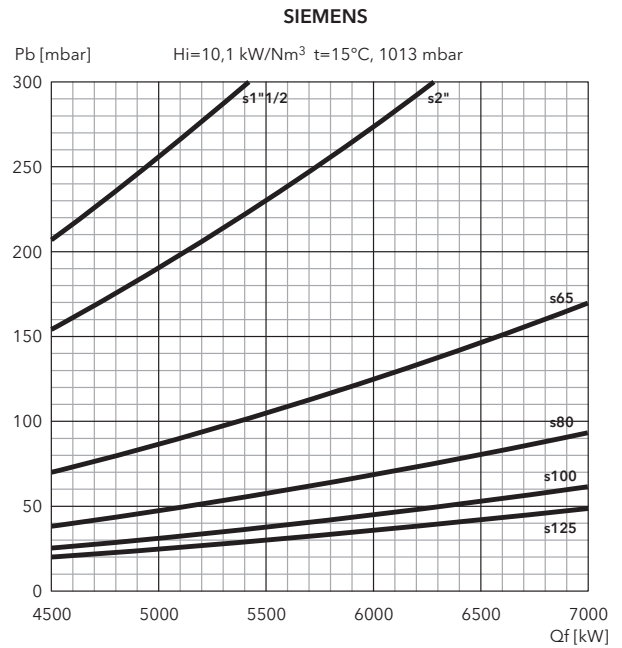
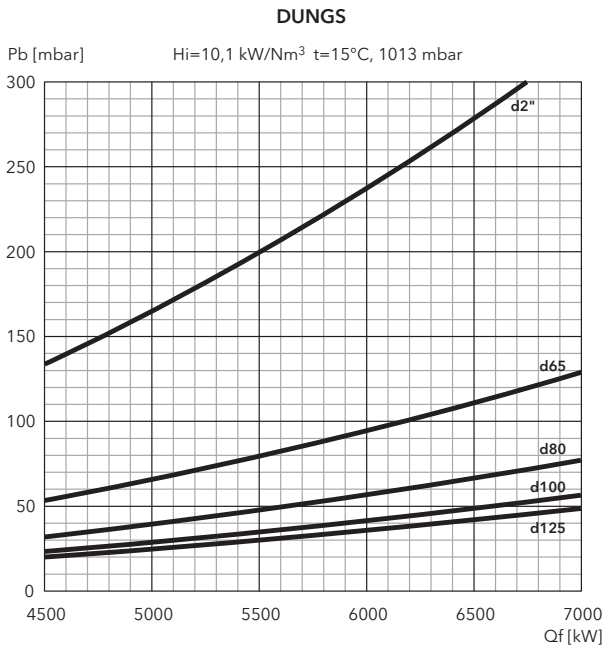

N8.7100 G-E

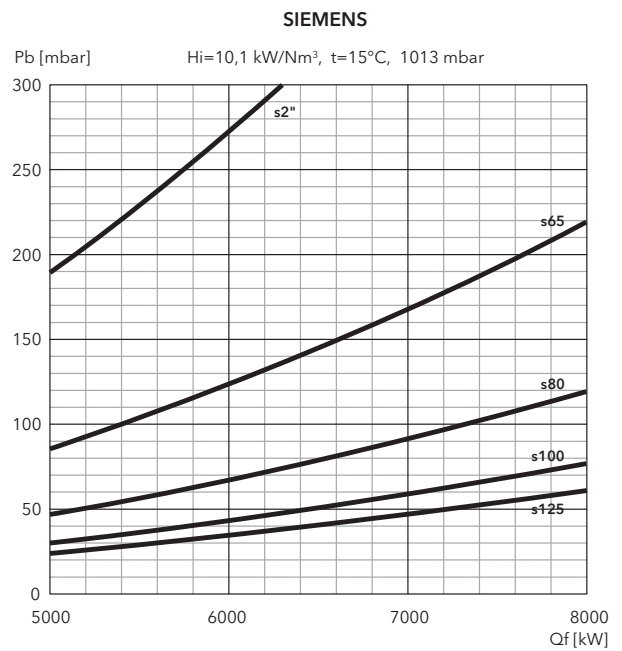
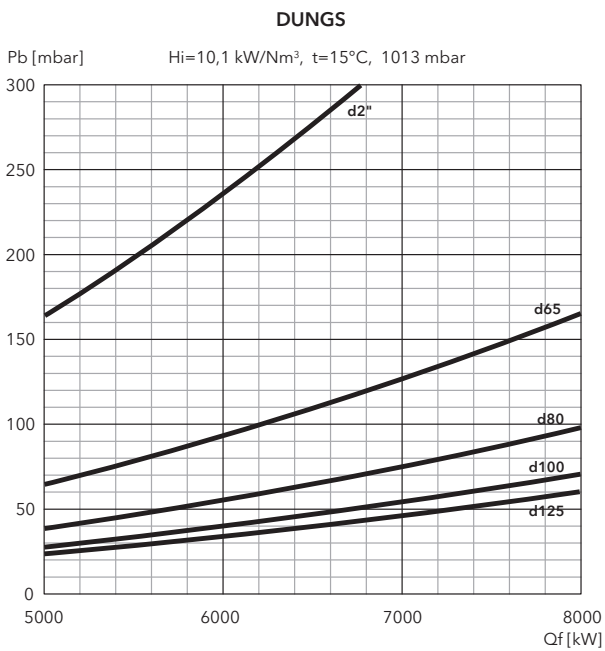

FILTERS

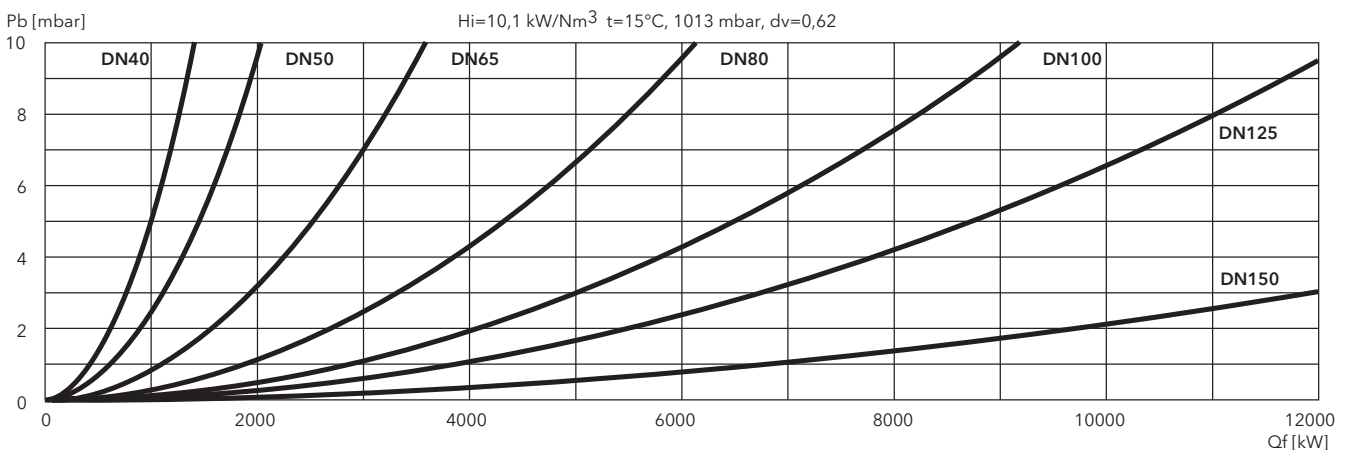

PRESSURE LOSSES (BURNER HEAD + GAS TRAIN)

N9.8700 G-E

DUNGS

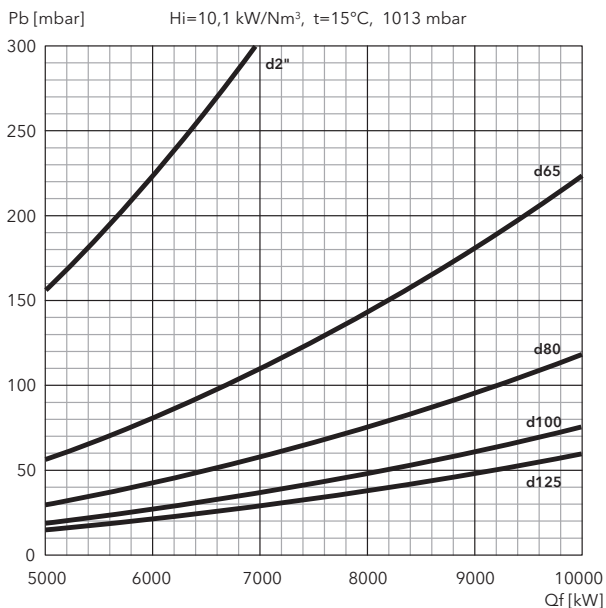

SIEMENS

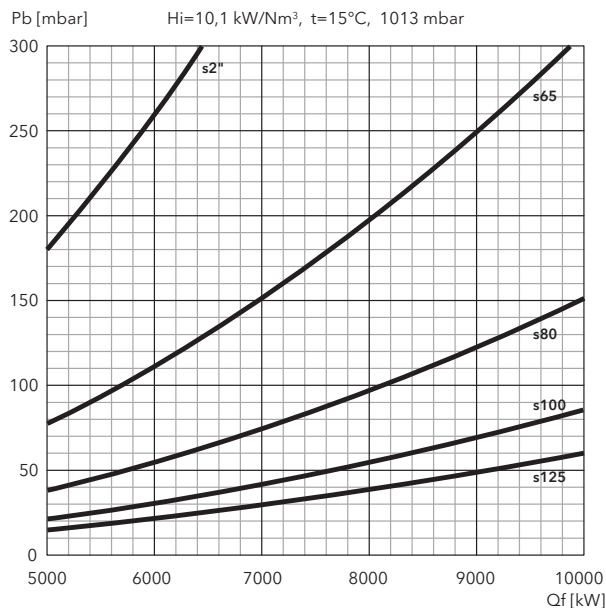

N9.10400 G-E

DUNGS

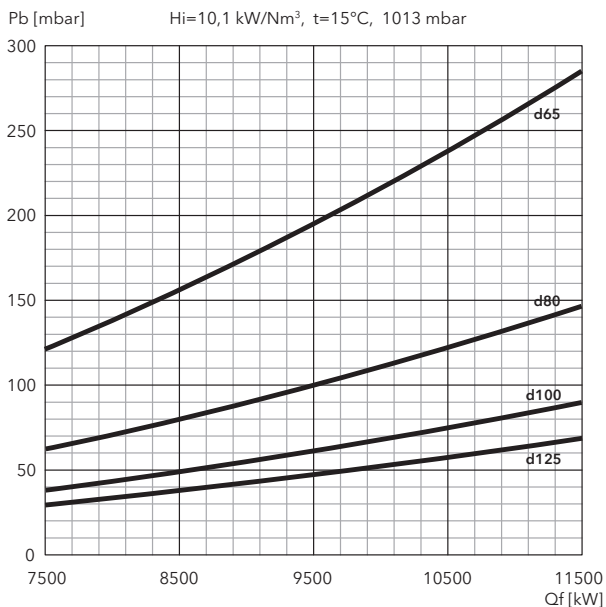

SIEMENS

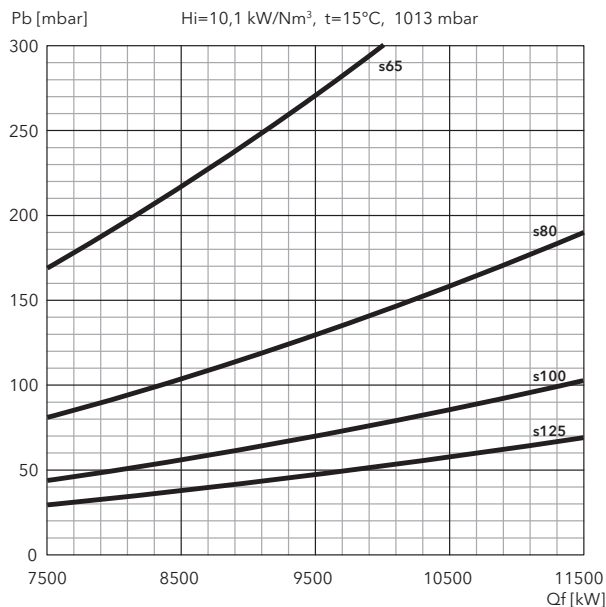

FILTERS

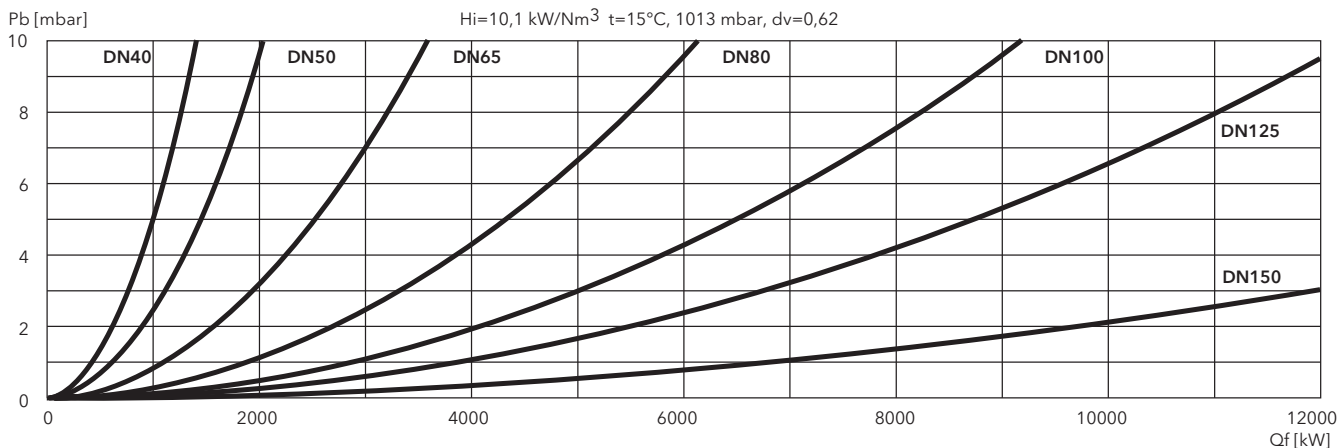

N6 G-EF3, N7 G-EF3

340 ... 4200 kW
2 stage progressive/modulating electronic (Low NOx class 3)

- **Fuels:** natural gas, low calorific value 6,99 ... 11,39 kWh/m³;
LPG, low calorific value 25,89 kWh/m³
- **Emission class:** Low NOx class 3 (<80 mg/kWh) according to EN676
- **Modulating ratio:** 1:5
- **Electrical power supply:** single-phase 230 V - 50 Hz
- **Protection level:** IP 41



TECHNICAL DATA

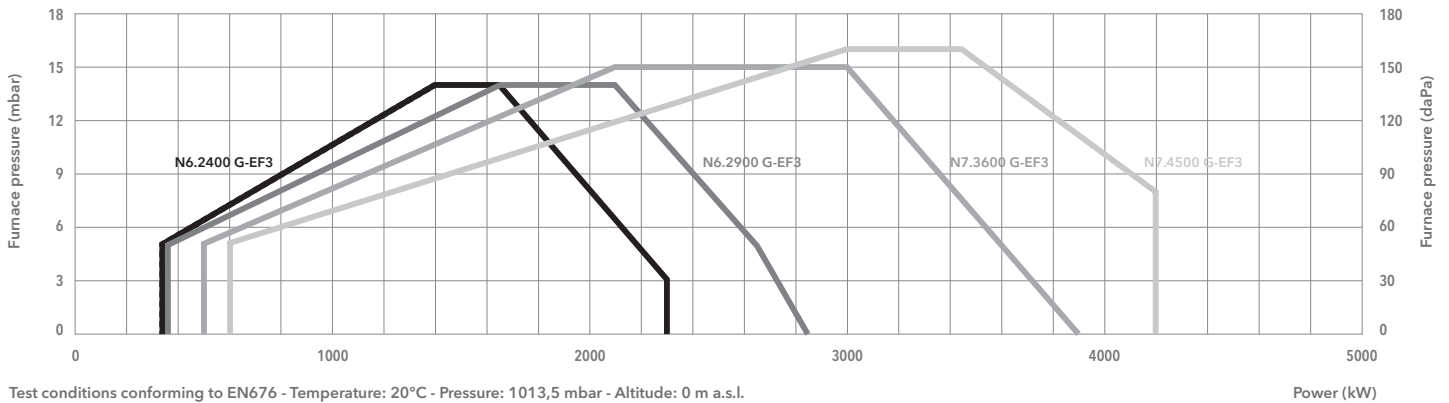

Test conditions conforming to EN676 - Temperature: 20°C - Pressure: 1013,5 mbar - Altitude: 0 m a.s.l.

Power (kW)

	N6.2400 G-EF3	N6.2900 G-EF3	N7.3600 G-EF3	N7.4500 G-EF3
Operating range	340 - 2300 kW	360 - 2850 kW	500 - 3900 kW	600 - 4200 kW
Gas pressure	50 - 500 mbar (50 - 360 mbar for d452 and d453 gas train)		50 - 500 mbar (50 - 360 mbar for d452 and d453 gas train)	
Control box / flame detector	BT300 / QRA2		BT300 / QRA2	
Auxiliary voltage	1NPE AC 230 V - 50 Hz TN-S		1NPE AC 230 V - 50 Hz TN-S	
Power supply	3PE AC 400 V - 50 Hz		3PE AC 400 V - 50 Hz	
Fan motor	50 Hz - 3 kW	50 Hz - 4 kW	50 Hz - 7,5 kW	50 Hz - 7,5 kW
Acoustic level	<70 dB(A)	<71 dB(A)	<74 dB(A)	<75 dB(A)
CE certificate	0085CL0215		0085CL0215	
Burner body	3750559	3750572	3750585	3750598
Combustion head	KN	3750259	3750262	3750265
	KM	3750260	3750263	3750266
	KL	3750261	3750264	3750267

GAS TRAINS

DUNGS

Model	Code
GT-d452-1"1/2	3750510
GT-d453-2"	3750511
GT-d454-65	3750512
GT-d455-80	3750513
GT-d456-100	3750514

SIEMENS

Model	Code
GT-s451-1"1/2	3750525
GT-s452-2"	3750526
GT-s453-65	3750527
GT-s454-80	3750528
GT-s455-100	3750529
GT-s456-125	3750530

FILTERS

Model	Code
FG-Rp1"1/2	3750543
FG-Rp2"	3750544
FG-DN65	3750545
FG-DN80	3750546
FG-DN100	3750547
FG-DN125	3750548

i Pressure drops graphs: see following pages
Dimensions of gas trains and gas filters: see pag. 200



DIMENSIONS (mm)

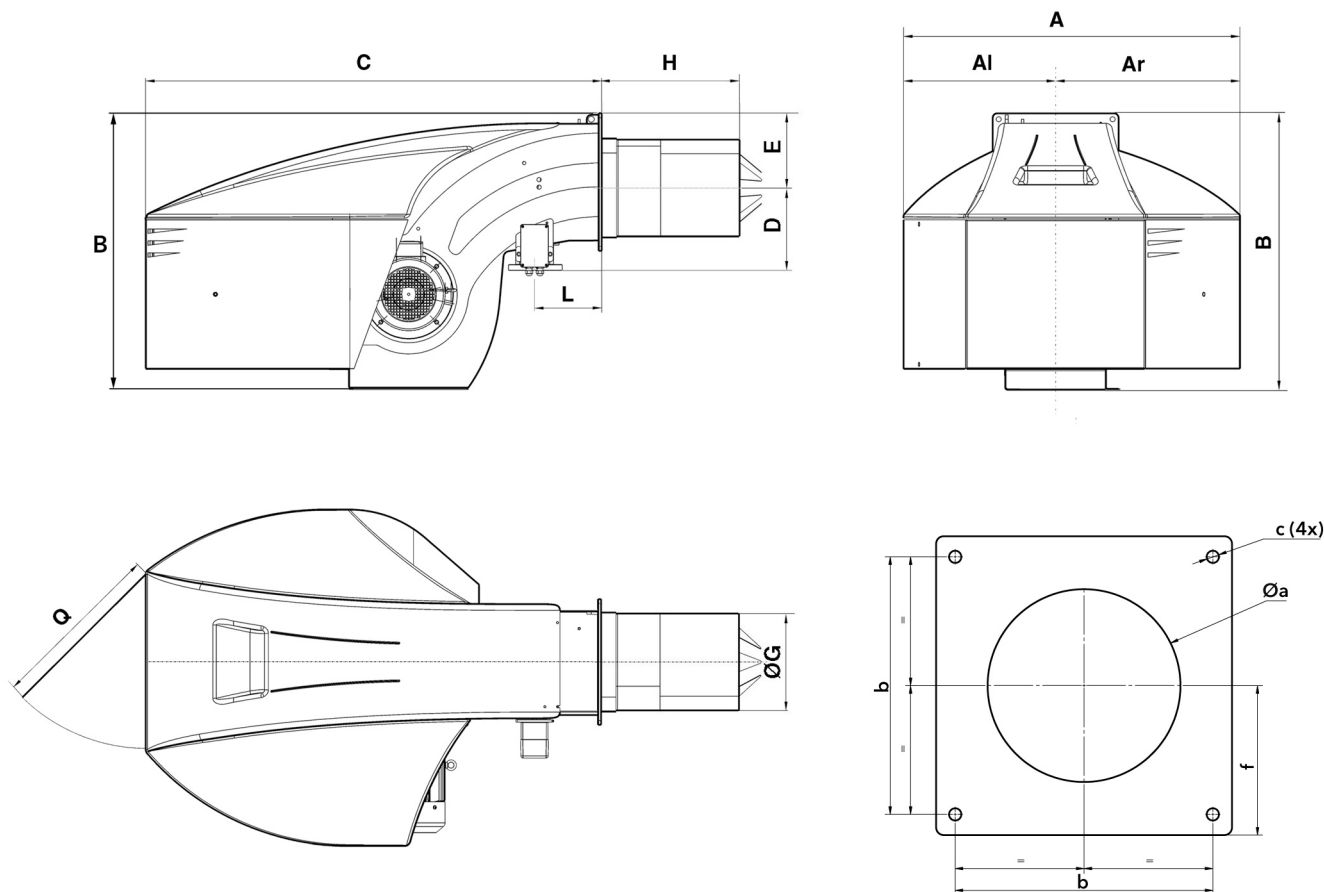

Model	A	Al	Ar	B	C	D	E	ØG	H			L	Q	Øa	b	c	f
									KN	KM	KL						
N6	990	479	510	837	1361	245	225	264	400	520	640	215	600	330-340	340	M16	200
N7	1128	511	618	961	1529	276	255	326	420	550	680	225	600	380-400	400	M16	235

PACKAGING

- The burner is delivered in 2 packages containing:
- burner body with mounted combustion head, boiler fixing accessories and technical documentation;
 - gas train and filter.

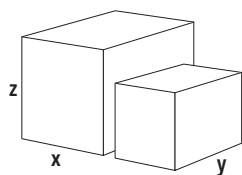

Models		Dimensions (mm)			Gross weight (kg)
		X	Y	Z	
N6.2400 G-EF3	KN	1861	990	837	280
	KM	1981	990	837	280
	KL	2101	990	837	280
N6.2900 G-EF3	KN	1861	990	837	290
	KM	1981	990	837	290
	KL	2101	990	837	290
N7.3600 G-EF3	KN	2049	1128	961	320
	KM	2179	1128	961	320
	KL	2309	1128	961	320
N7.4500 G-EF3	KN	2049	1128	961	330
	KM	2179	1128	961	330
	KL	2309	1128	961	330

PRESSURE LOSSES (BURNER HEAD + GAS TRAIN)

N6.2400 G-EF3

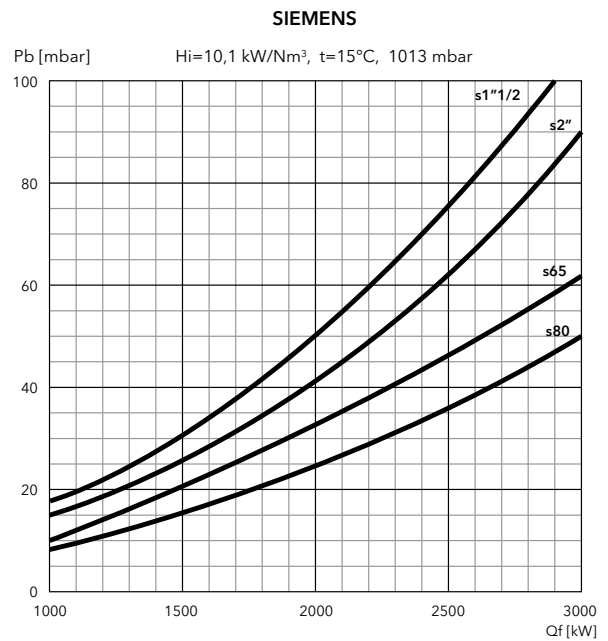
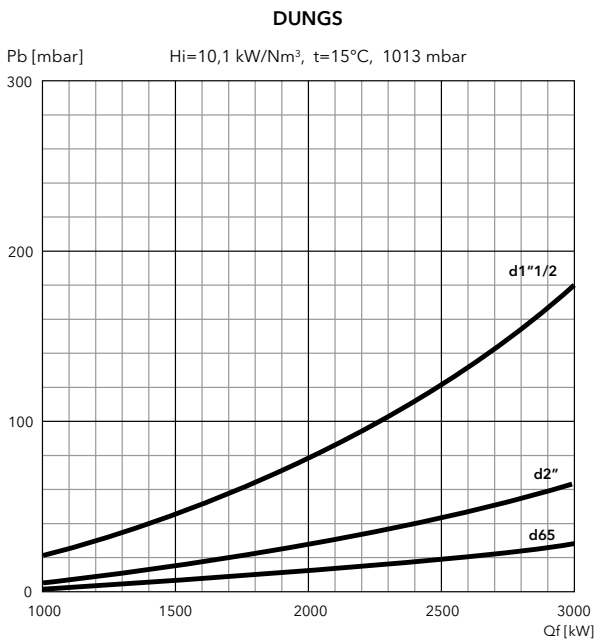

N6.2900 G-EF3

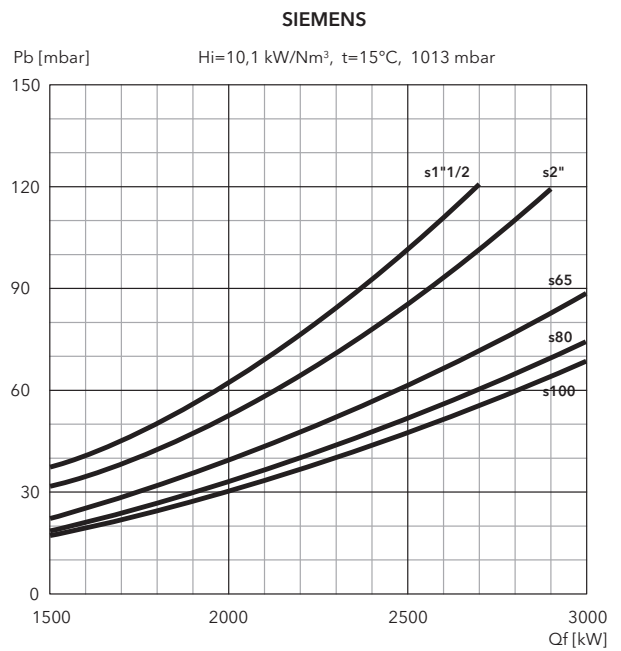
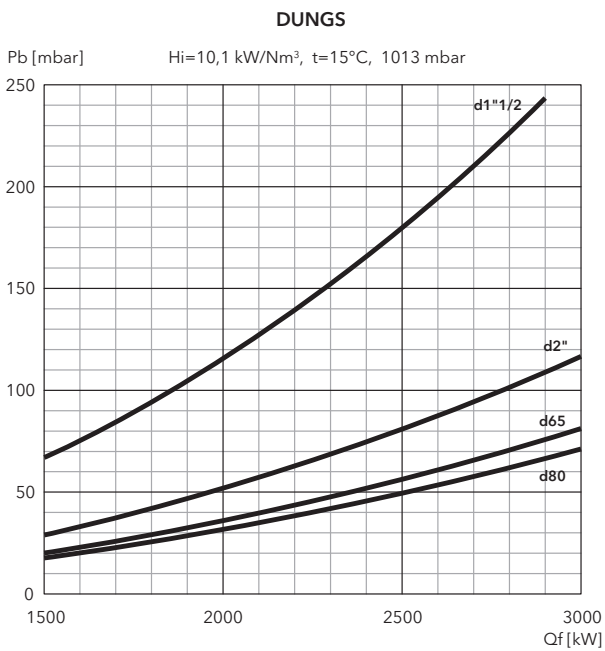

FILTERS

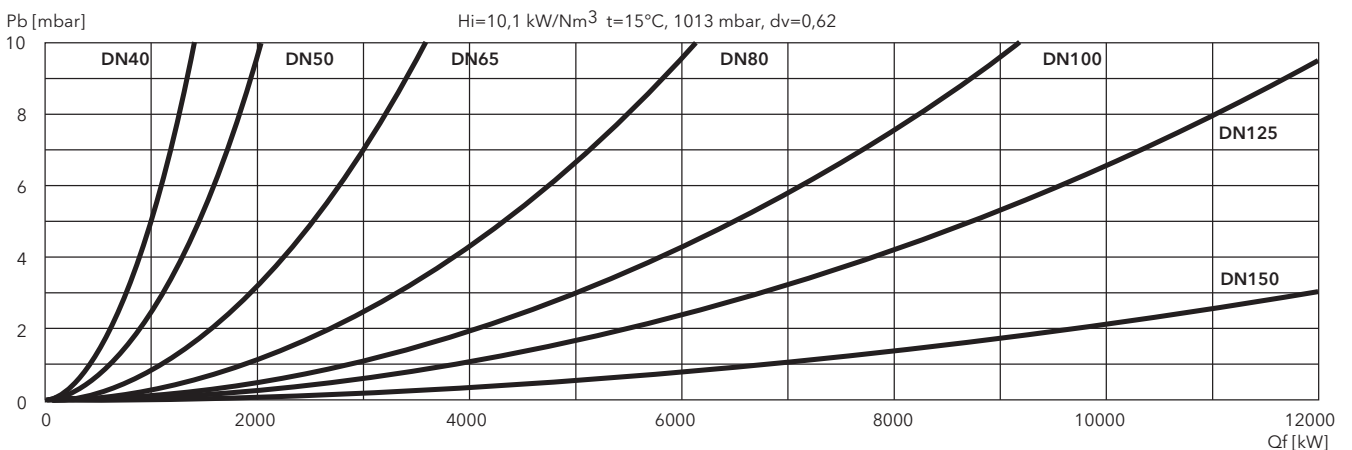

PRESSURE LOSSES (BURNER HEAD + GAS TRAIN)

N7.3600 G-EF3

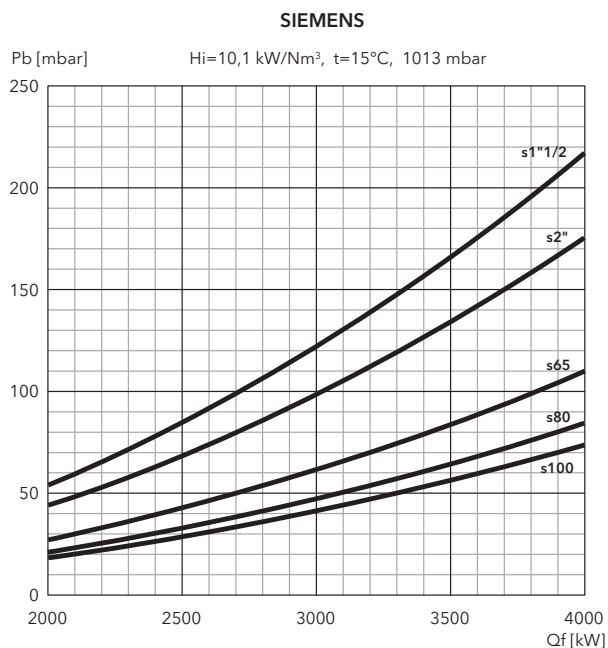
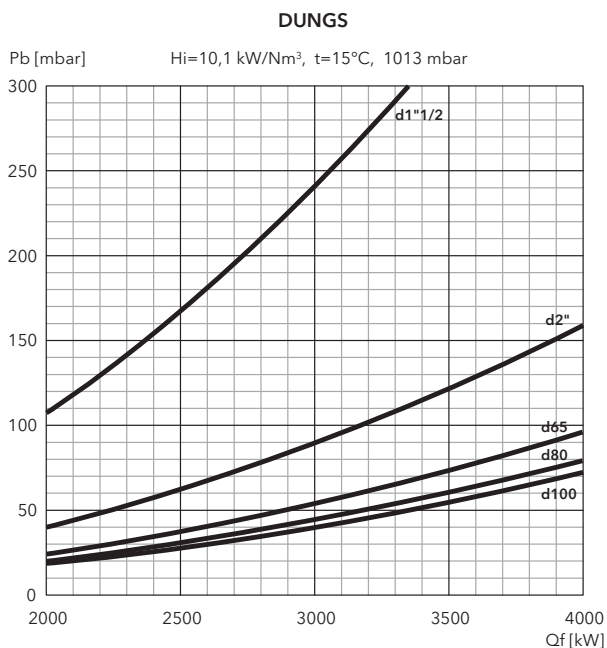

N7.4500 G-EF3

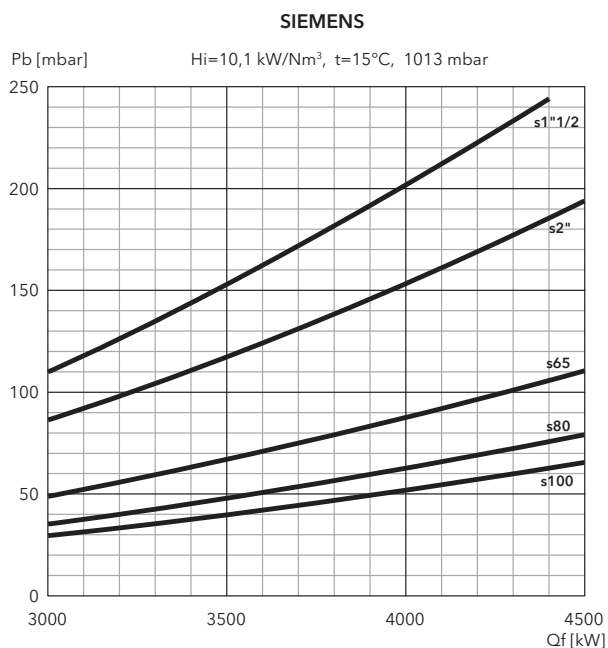
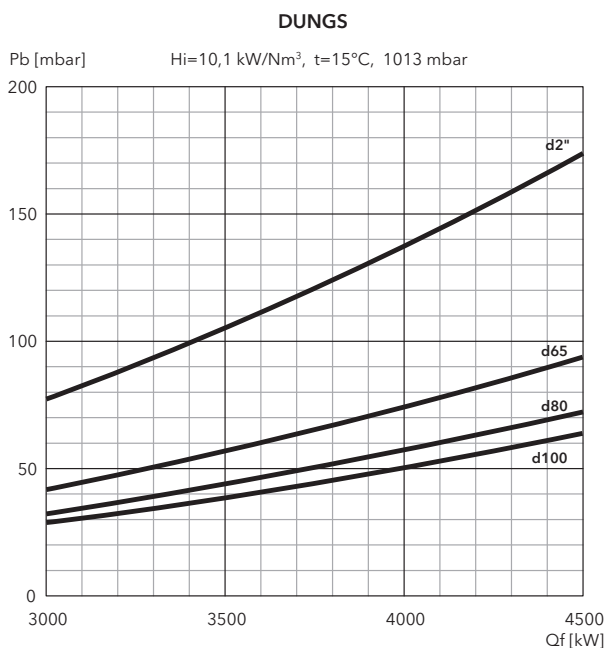

FILTERS

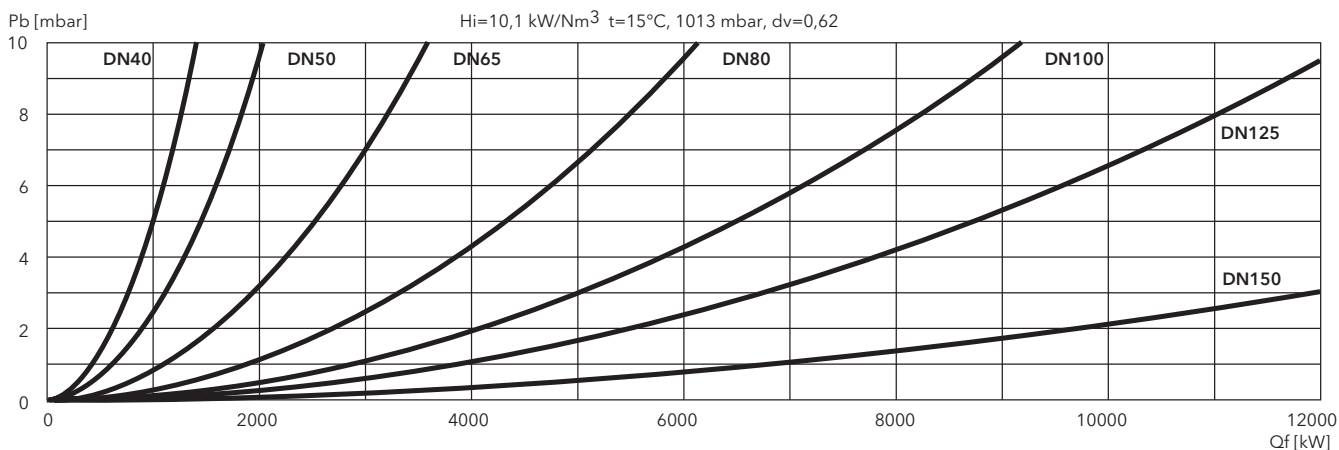

N8 G-EU3, N9 G-EU3

640 ... 10200 kW

2 stage progressive/modulating electronic (Low NOx class 3)

- **Fuels:** natural gas, low calorific value 6,99 ... 11,39 kWh/m³;
LPG, low calorific value 25,89 kWh/m³
- **Emission class:** Low NOx class 3 (<80 mg/kWh) according to EN676
- **Modulating ratio:** 1:10
- **Electrical power supply:** single-phase 230 V - 50 Hz
- **Protection level:** IP 41



TECHNICAL DATA

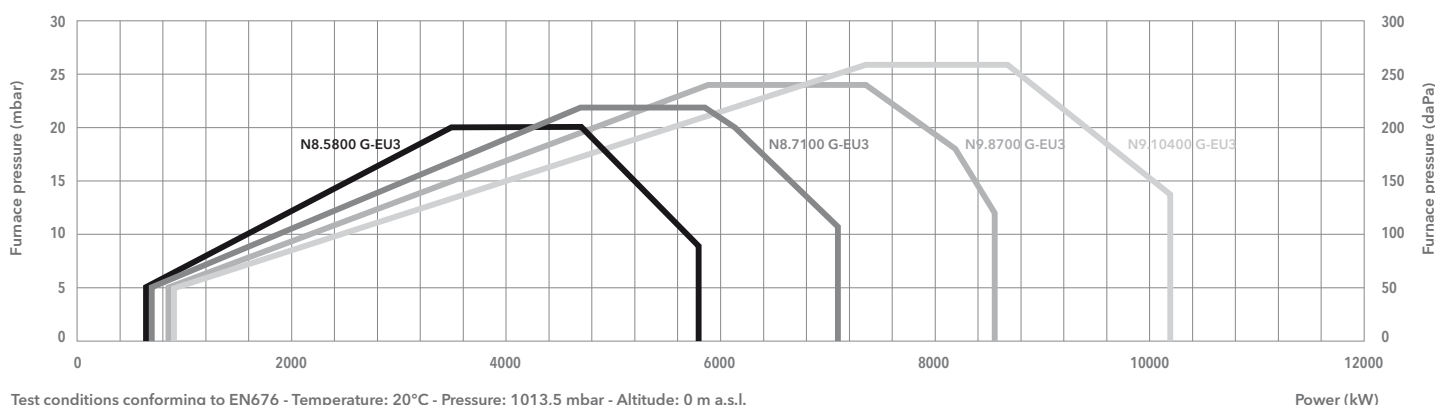

	N8.5800 G-EU3	N8.7100 G-EU3	N9.8700 G-EU3	N9.10400 G-EU3
Operating range	640 - 5800 kW	700 - 7100 kW	850 - 8530 kW	900 - 10200 kW
Gas pressure	70 - 500 mbar (70 - 360 mbar for d457 gas train)		80 - 500 mbar (80 - 360 mbar for d457 gas train)	
Control box / flame detector	BT300 / Ionisation	BT300 / Ionisation	BT300 / Ionisation	BT300 / Ionisation
Auxiliary voltage	1NPE AC 230 V - 50 Hz TN-S	1NPE AC 230 V - 50 Hz TN-S	1NPE AC 230 V - 50 Hz TN-S	1NPE AC 230 V - 50 Hz TN-S
Power supply	3PE AC 400 V - 50 Hz	3PE AC 400 V - 50 Hz	3PE AC 400 V - 50 Hz	3PE AC 400 V - 50 Hz
Fan motor	50 Hz - 11 kW	50 Hz - 15 kW	50 Hz - 18,5 kW	50 Hz - 22 kW
Acoustic level	<78 dB(A)	<78 dB(A)	<80 dB(A)	<81 dB(A)
CE certificate	0085CL0215	0085CL0215	0085CL0215	0085CL0215
Burner body	3750474	3750475	3750476	3750477
Combustion head	KN	3750490	3750492	3750493
	KM	3750494	3750496	3750497
	KL	3750498	3750499	3750501

GAS TRAINS

DUNGS

Model	Code
GT-d457-2"	3750515
GT-d458-65	3750516
GT-d459-80	3750517
GT-d460-100	3750518

SIEMENS

Model	Code
GT-s457-2"	3750537
GT-s458-65	3750538
GT-s459-80	3750539
GT-s460-100	3750540
GT-s461-125	3750541

FILTERS

Model	Code
FG-Rp2"	3750544
FG-DN65	3750545
FG-DN80	3750546
FG-DN100	3750547
FG-DN125	3750548

Pressure drops graphs: see following pages
Dimensions of gas trains and gas filters: see pag. 201



DIMENSIONS (mm)

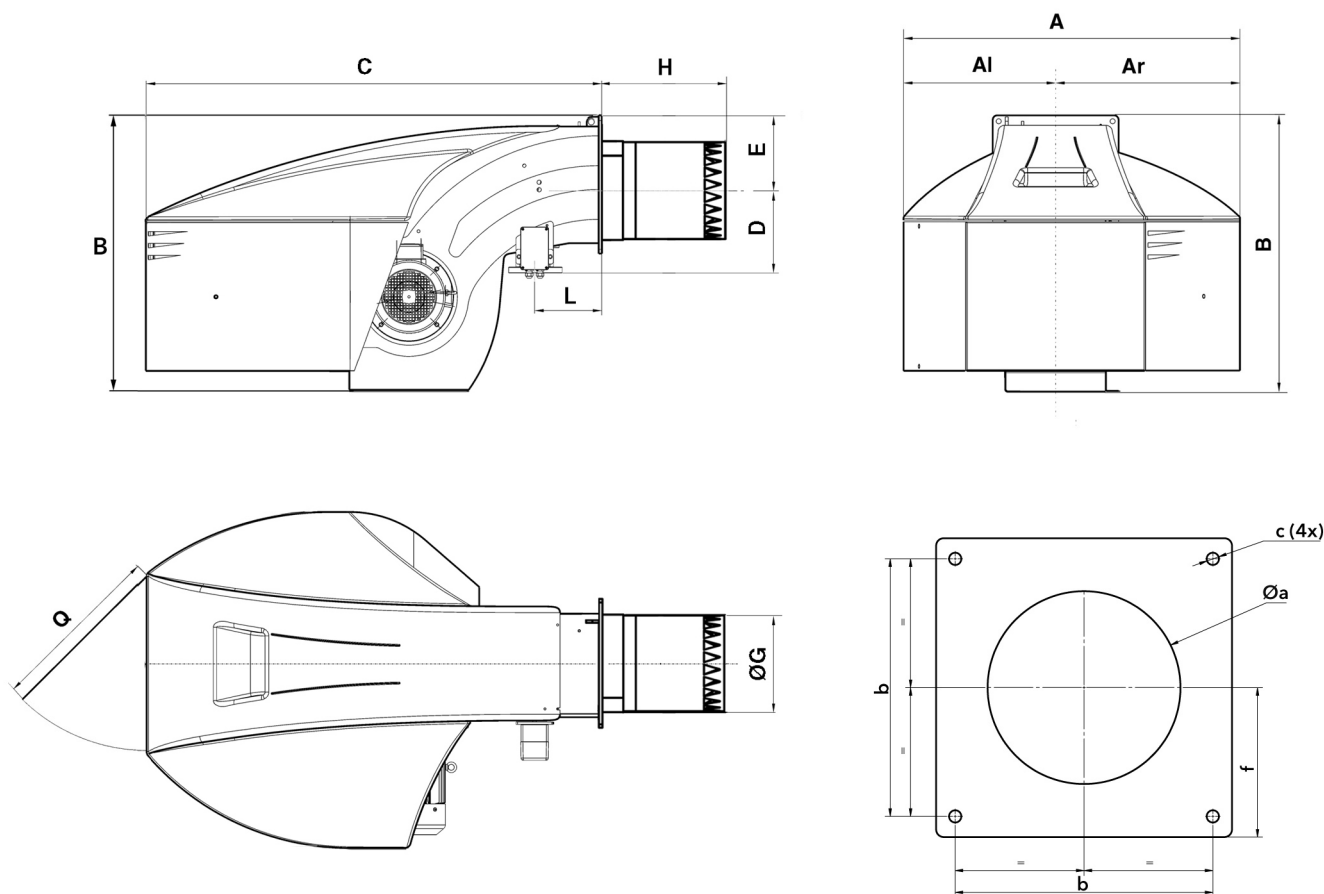

Model	A	Al	Ar	B	C	D	E	ØG	H			L	Q	Øa	b	c	f
									KN	KM	KL						
N8	1414	669	745	1231	1930	344	293	369	500	640	780	230	800	390-410	505	M20	293
N9	1414	669	745	1291	1928	369	293	431,5	550	700	850	230	800	460-480	505	M20	293

PACKAGING

- The burner is delivered in 2 packages containing:
- burner body with mounted combustion head, boiler fixing accessories and technical documentation;
 - gas train and filter.

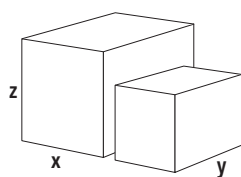

Models		Dimensions (mm)			Gross weight (kg)
		X	Y	Z	
N8.5800 G-EU3	KN	2530	1414	1231	527
	KM	2670	1414	1231	527
	KL	2810	1414	1231	527
N8.7100 G-EU3	KN	2530	1414	1231	535
	KM	2670	1414	1231	535
	KL	2810	1414	1231	535
N9.8700 G-EU3	KN	2430	1414	1231	527
	KM	2570	1414	1231	527
	KL	2710	1414	1231	527
N9.10400 G-EU3	KN	2580	1414	1231	535
	KM	2730	1414	1231	535
	KL	2880	1414	1231	535

PRESSURE LOSSES (BURNER HEAD + GAS TRAIN)

N8.5800 G-EU3

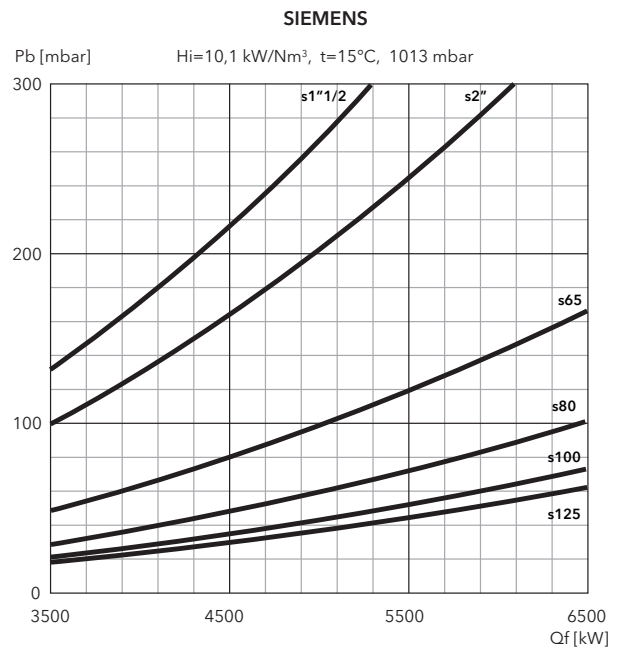
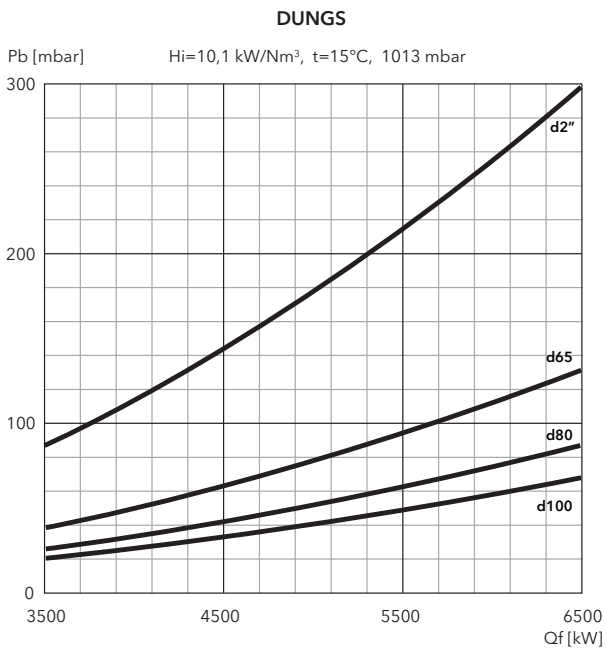

N8.7100 G-EU3

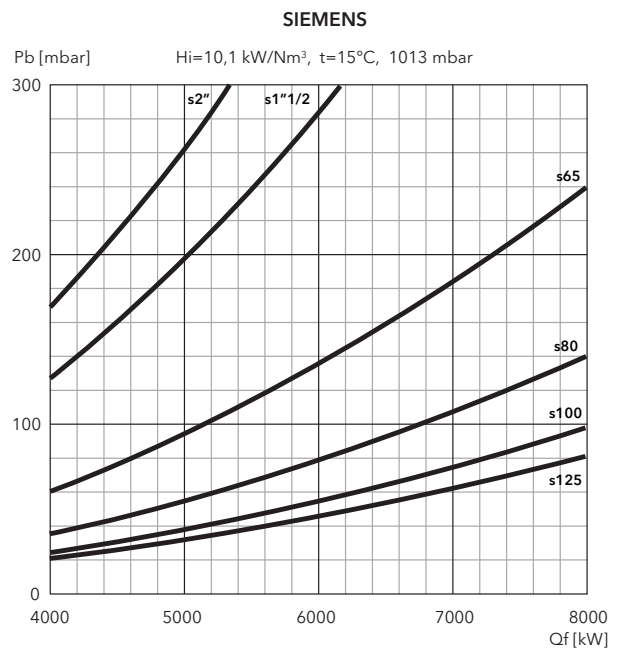
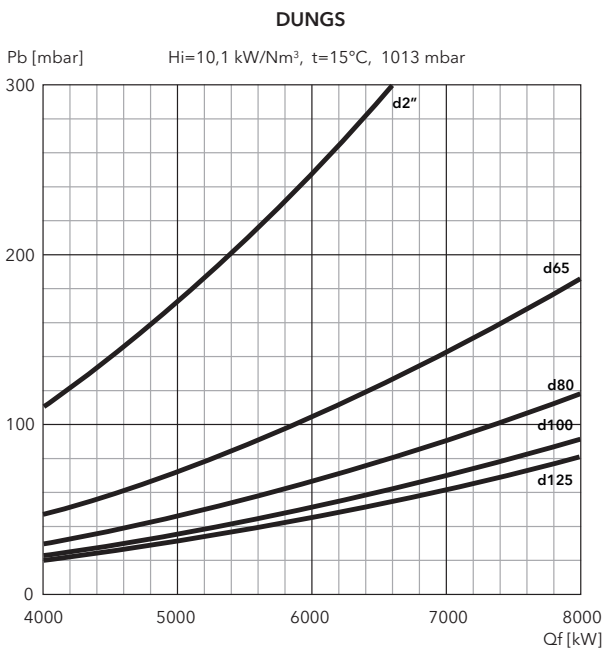

FILTERS

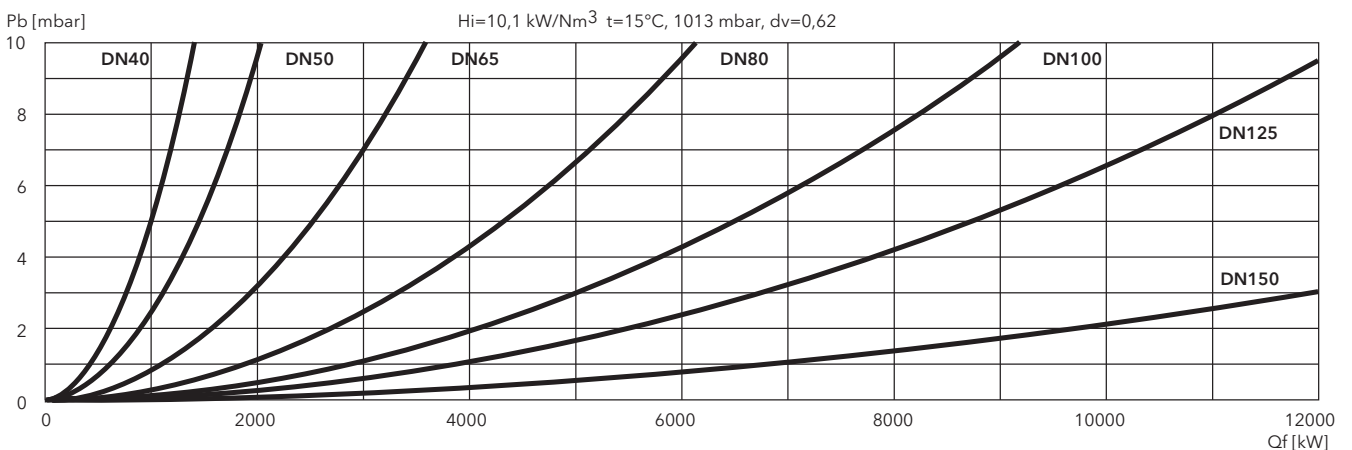

PRESSURE LOSSES (BURNER HEAD + GAS TRAIN)

N9.8700 G-EU3

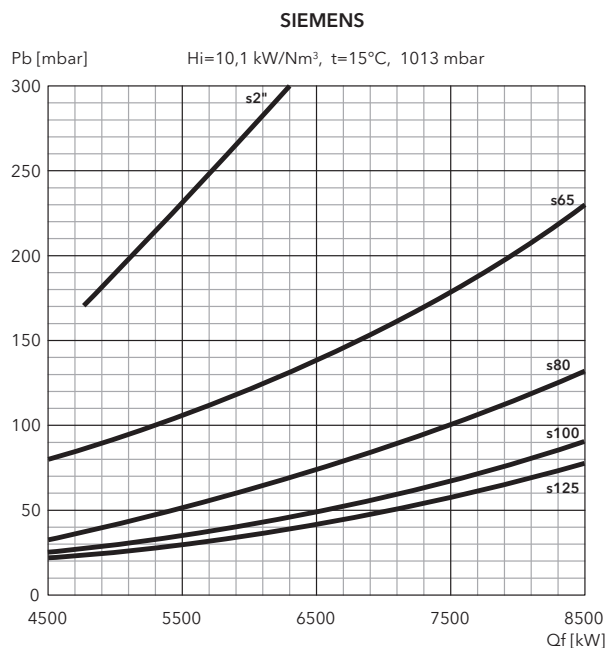
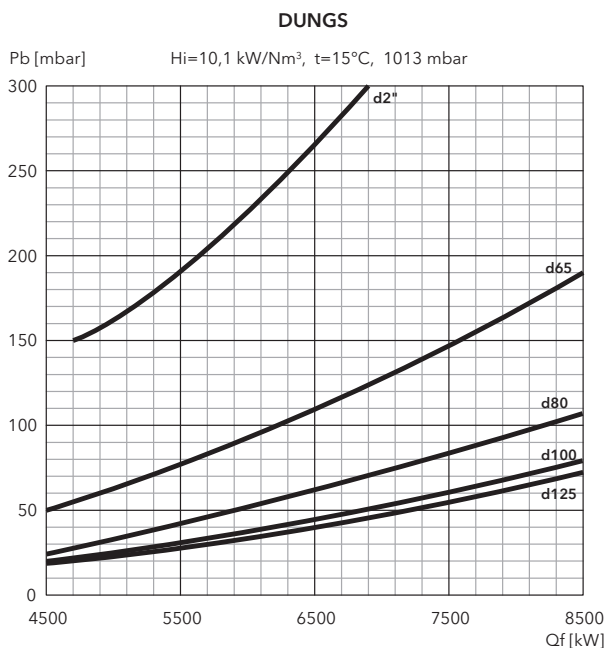

N9.10400 G-EU3

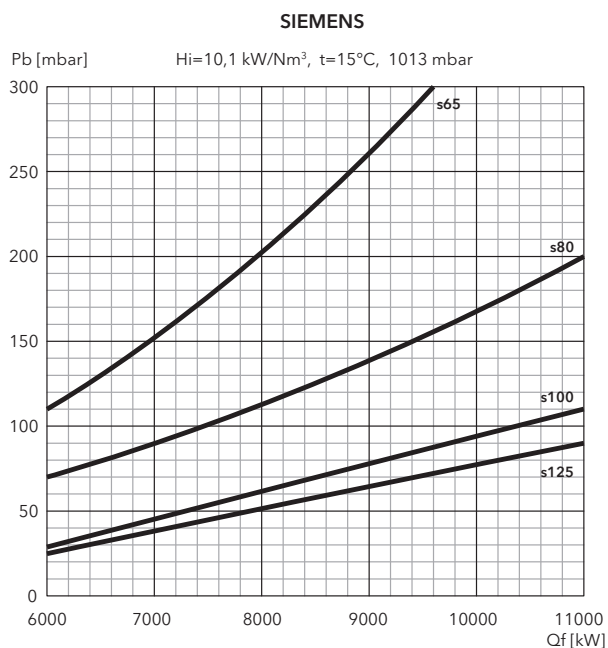
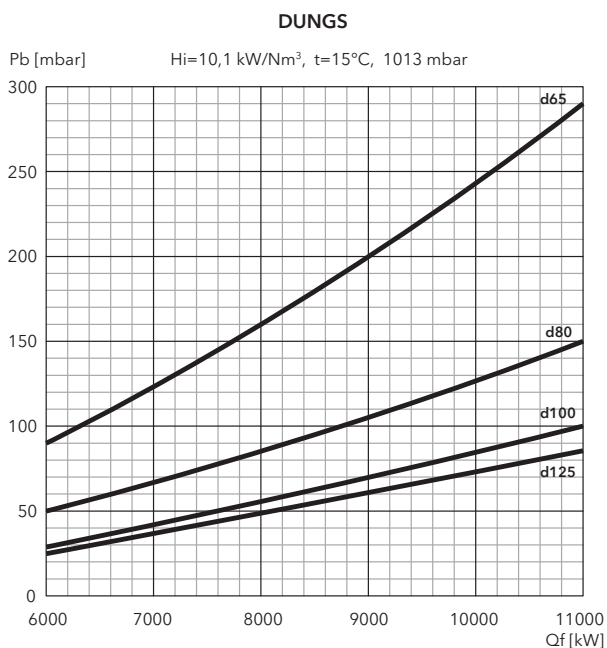

FILTERS

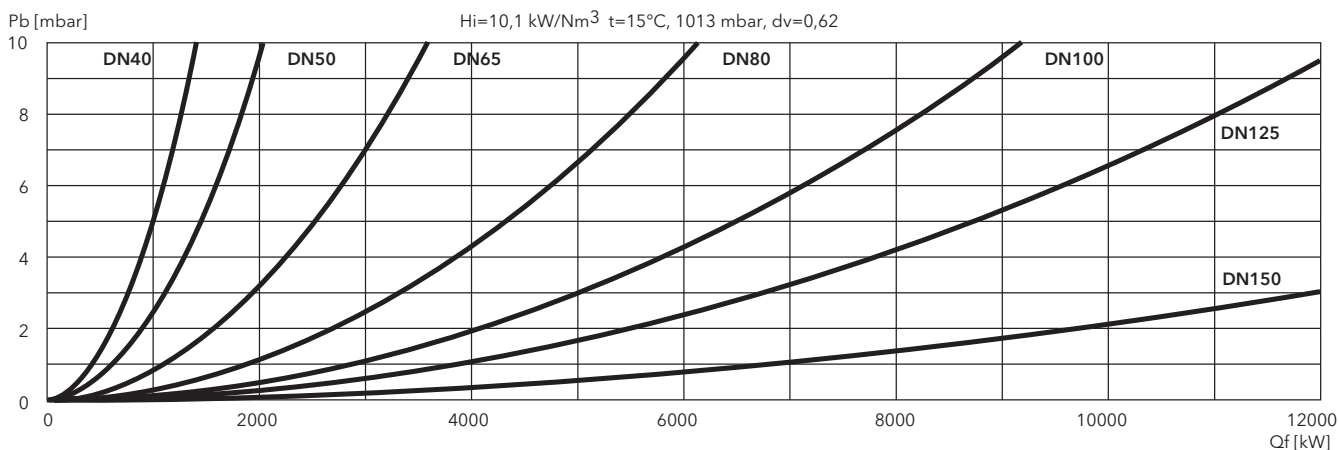

N6 GL-RZ3, N7 GL-RZ3

290 ... 4350 kW

2 stage progressive/modulating mechanical in gas / 3 stages in light oil

- **Fuels:** natural gas, low calorific value 6,99 ... 11,39 kWh/m³;
light oil, viscosity 6 mm²/s at 20°C, low calorific value 11,86 kWh/kg
- **Emission class:** Low NOx class 2 (<120 mg/kWh) according to EN676 in gas
Low NOx class 2 (<85 mg/kWh) according to EN267 in light oil
- **Electrical power supply:** single-phase 230 V - 50 Hz
- **Protection level:** IP 41



TECHNICAL DATA

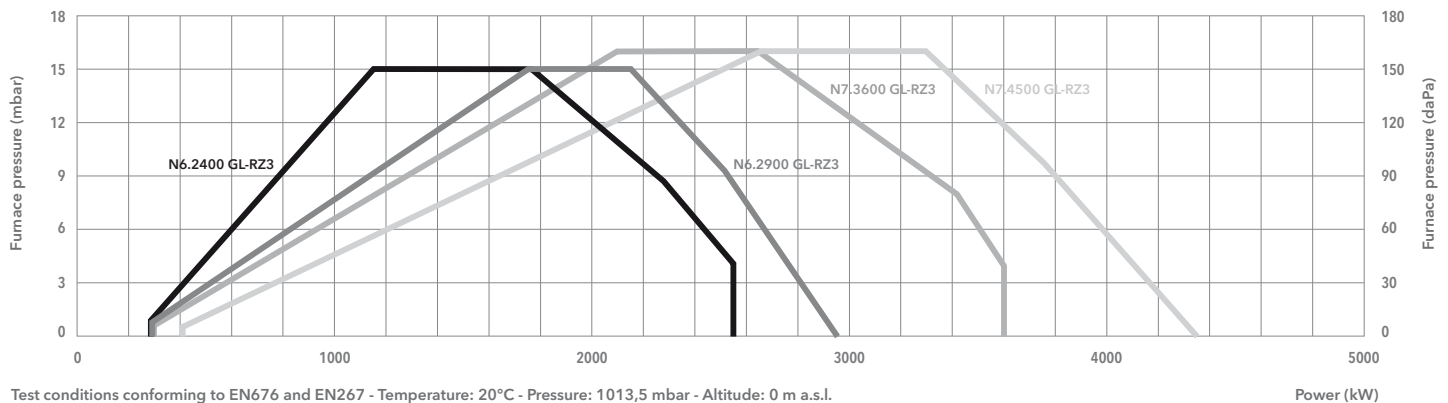

Test conditions conforming to EN676 and EN267 - Temperature: 20°C - Pressure: 1013,5 mbar - Altitude: 0 m a.s.l.

Power (kW)

	N6.2400 GL-RZ3	N6.2900 GL-RZ3	N7.3600 GL-RZ3	N7.4500 GL-RZ3/LFL
Operating range gas	290 - 2550 kW	290 - 2950 kW	300 - 3600 kW	410 - 4350 kW
Operating range oil	730 - 2470 kW	730 - 2750 kW	1090 - 3600 kW	1230 - 4350 kW
Gas pressure	50 - 500 mbar (50 - 360 mbar for d552 and d553 gas train)		50 - 500 mbar (50 - 360 mbar for d552 and d553 gas train)	
Auxiliary voltage	1NPE AC 230 V - 50 Hz TN-S	1NPE AC 230 V - 50 Hz TN-S	1NPE AC 230 V - 50 Hz TN-S	1NPE AC 230 V - 50 Hz TN-S
Power supply	3PE AC 400 V - 50 Hz	3PE AC 400 V - 50 Hz	3PE AC 400 V - 50 Hz	3PE AC 400 V - 50 Hz
Control box / flame detector	LFL / QRA2	LFL / QRA2	LFL / QRA2	LFL / QRA2
Fan motor	50 Hz - 3 kW	50 Hz - 4 kW	50 Hz - 5,5 kW	50 Hz - 7,5 kW
Pump	SUNTEC J7CC	SUNTEC J7CC	SUNTEC TA3	SUNTEC TA3
Motor pump	50 Hz - 0,55 kW	50 Hz - 0,55 kW	50 Hz - 0,74 kW	50 Hz - 0,74 kW
Acoustic level	<70 dB(A)	<71 dB(A)	<74 dB(A)	<75,5 dB(A)
CE certificate	0085CL0215	0085CL0215	0085CL0215	0085CL0215
Burner body	3750414	3750415	3750416	3750417
Combustion head	KN 3750418	3750419	3750420	3750421
	KM 3750422	3750423	3750424	3750425
	KL 3750426	3750427	3750428	3750429

GAS TRAINS

DUNGS

Model	Code
GT-d552-1"1/2	3750504
GT-d553-2"	3750505
GT-d554-65	3750506
GT-d555-80	3750507
GT-d556-100	3750508

SIEMENS

Model	Code
GT-s551-1"1/2	3750519
GT-s552-2"	3750520
GT-s553-65	3750521
GT-s554-80	3750522
GT-s555-100	3750523
GT-s556-125	3750524

FILTERS

Model	Code
FG-Rp1"1/2	3750543
FG-Rp2"	3750544
FG-DN65	3750545
FG-DN80	3750546
FG-DN100	3750547
FG-DN125	3750548

 **Pressure drops graphs:** see following pages
Dimensions of gas trains and gas filters: see pag. 198



DIMENSIONS (mm)

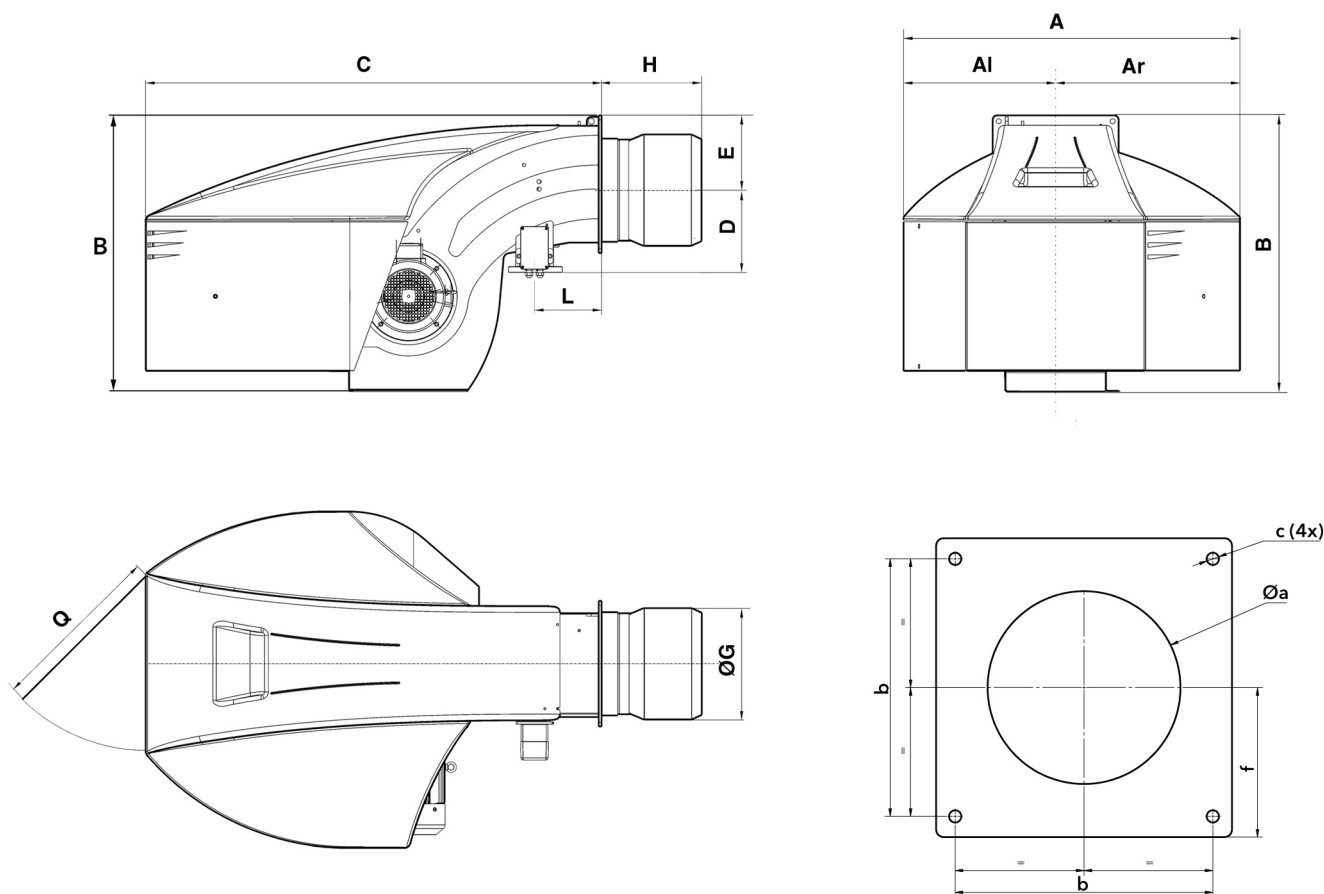

Model	A	Al	Ar	B	C	D	E	ØG	H			L	Q	Øa	b	c	f
									KN	KM	KL						
N6	990	479	510	837	1361	245	225	320	330	450	570	215	600	330-340	340	M16	200
N7.3600	1128	511	618	961	1529	276	255	320	375	505	635	225	600	330-400	400	M16	235
N7.4500	1128	511	618	961	1529	276	255	340	375	505	635	225	600	350-400	400	M16	235

PACKAGING

- The burner is delivered in 2 packages containing:
- burner body with mounted combustion head, boiler fixing accessories and technical documentation;
 - gas train and filter.

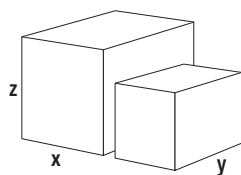

Models		Dimensions (mm)			Gross weight (kg)
		X	Y	Z	
N6.2400 GL-RZ3	KN	1691	990	837	320
	KM	1811	990	837	320
	KL	1931	990	837	320
N6.2900 GL-RZ3	KN	1691	990	837	330
	KM	1811	990	837	330
	KL	1931	990	837	330
N7.3600 GL-RZ3	KN	1904	1128	961	360
	KM	2034	1128	961	360
	KL	2164	1128	961	360
N7.4500 GL-RZ3	KN	1904	1128	961	370
	KM	2034	1128	961	370
	KL	2164	1128	961	370

PRESSURE LOSSES (BURNER HEAD + GAS TRAIN)

N6.2400 GL-RZ3

DUNGS

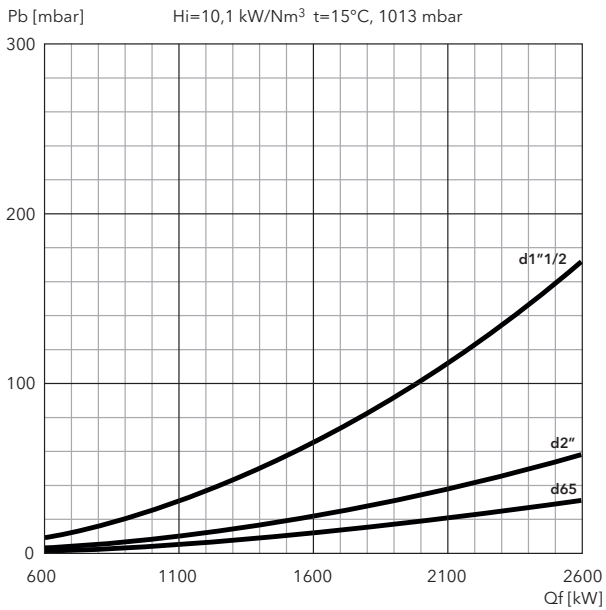

SIEMENS

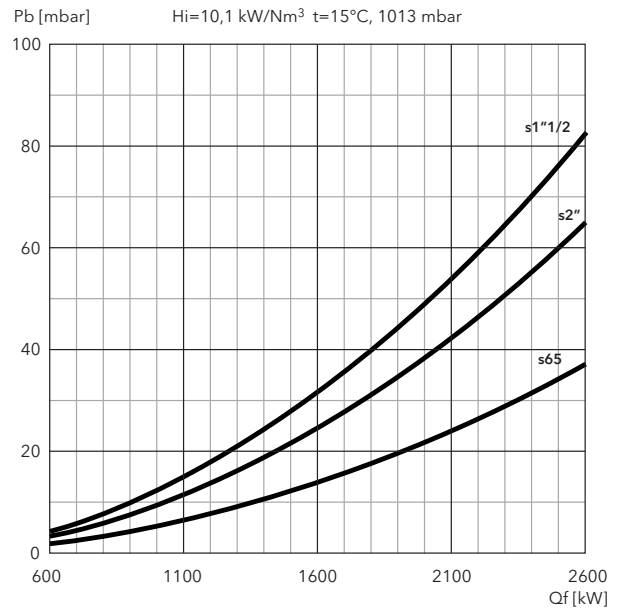

N6.2900 GL-RZ3

DUNGS

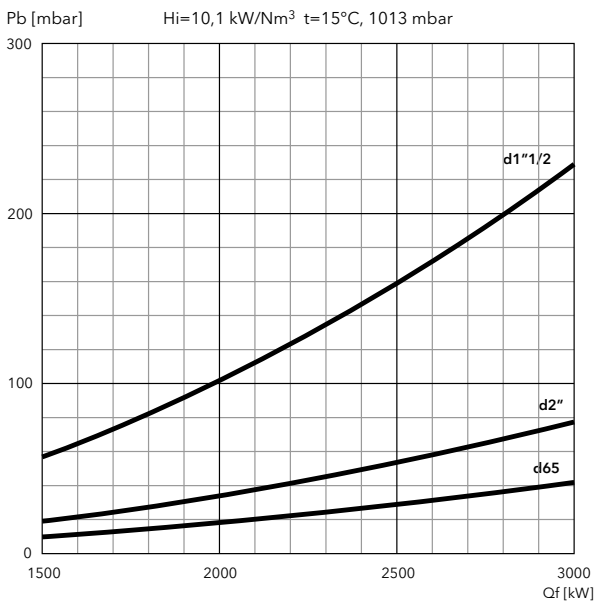

SIEMENS

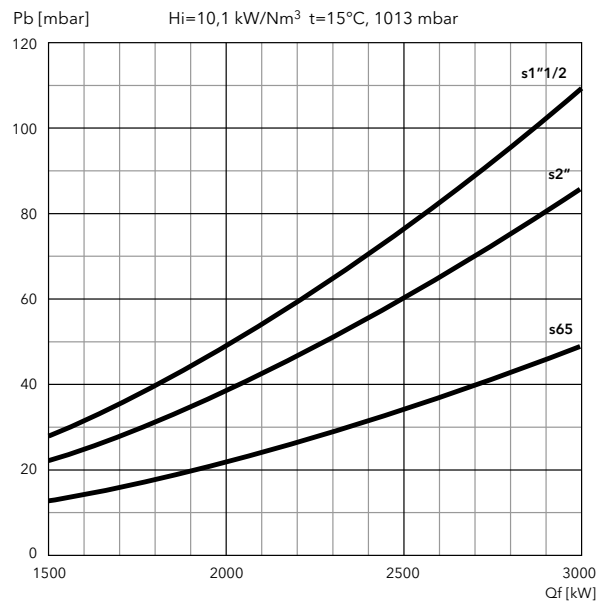

FILTERS

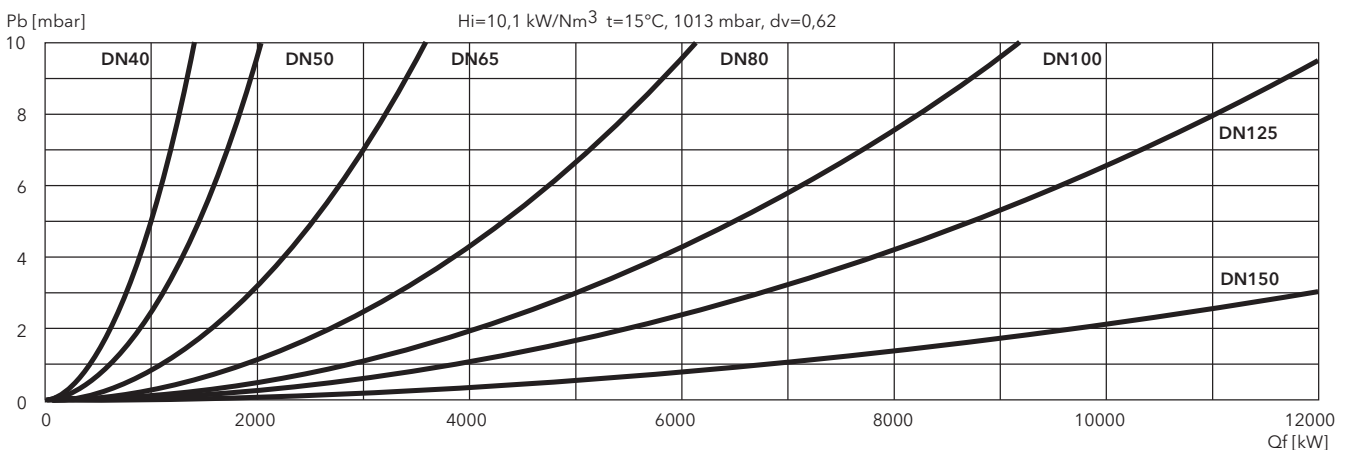

PRESSURE LOSSES (BURNER HEAD + GAS TRAIN)

N7.3600 GL-RZ3

DUNGS

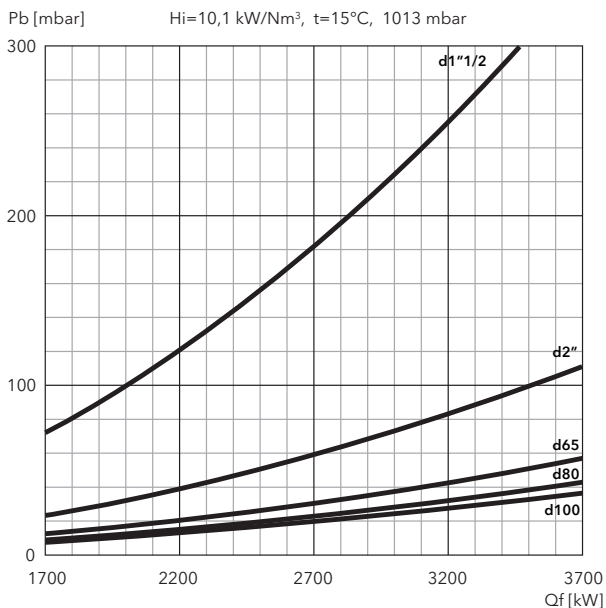

SIEMENS

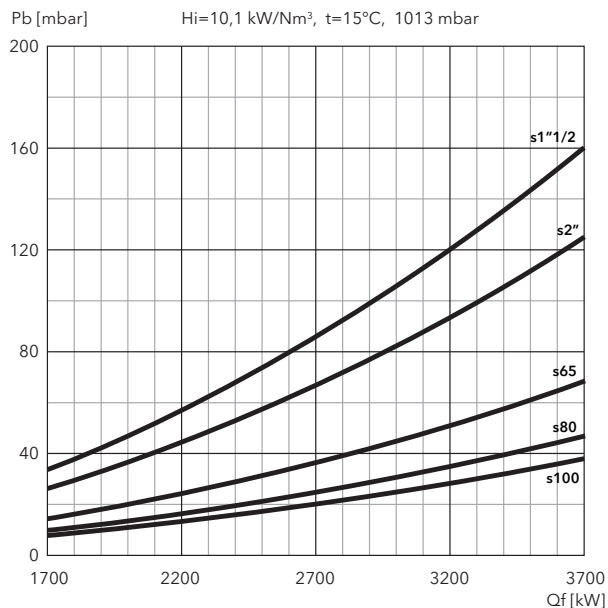

N7.4500 GL-RZ3/LFL

DUNGS

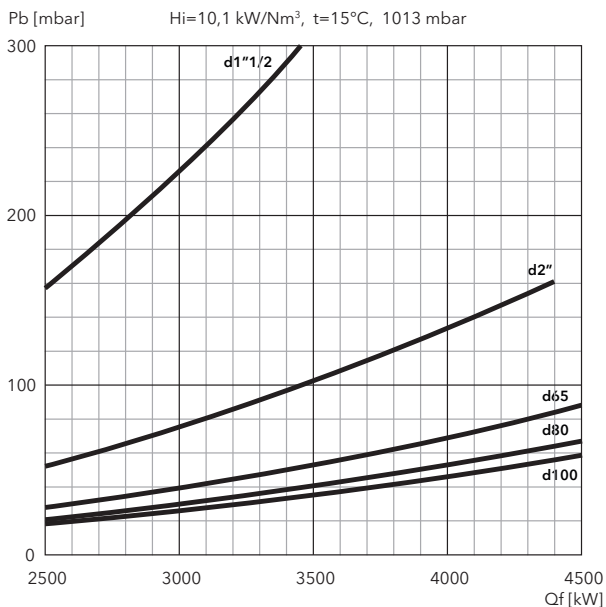

SIEMENS

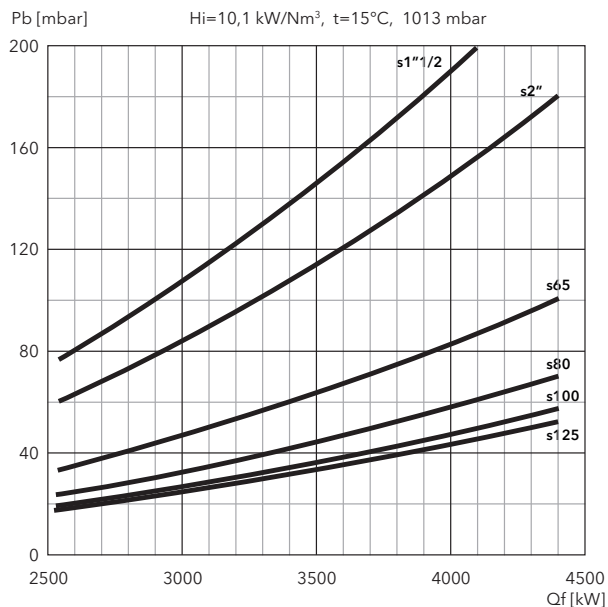

FILTERS

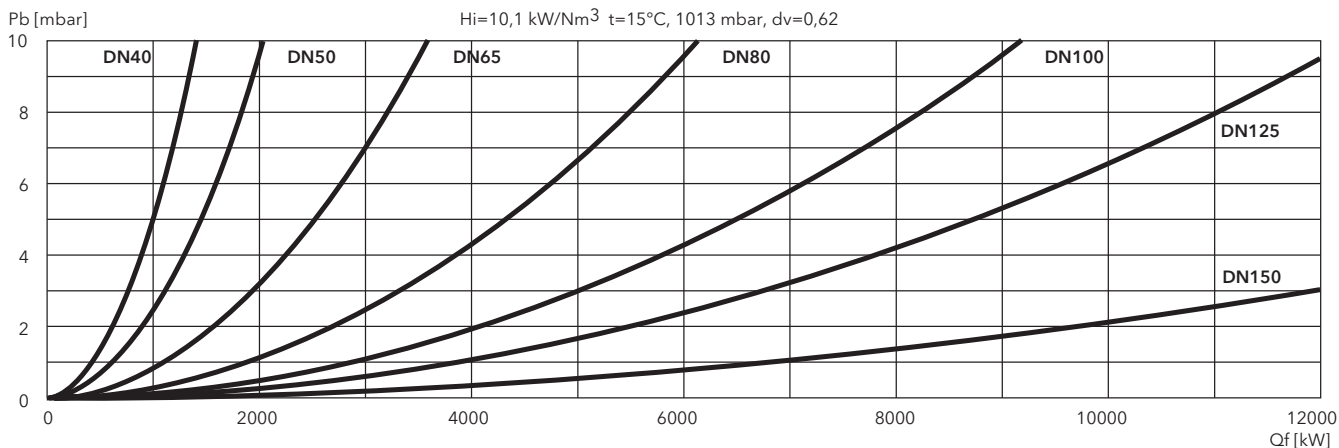

N6 GL-E, N7 GL-E

250 ... 4750 kW

2 stage progressive/modulating electronic

- **Fuels:** natural gas, low calorific value 6,99 ... 11,39 kWh/m³;
light oil, viscosity 6 mm²/s at 20°C, low calorific value 11,86 kWh/kg
- **Emission class:** Low NOx class 2 (<120 mg/kWh) according to EN676 in gas
Low NOx class 2 (<85 mg/kWh) according to EN267 in light oil
- **Electrical power supply:** single-phase 230 V - 50 Hz
- **Protection level:** IP 41



TECHNICAL DATA

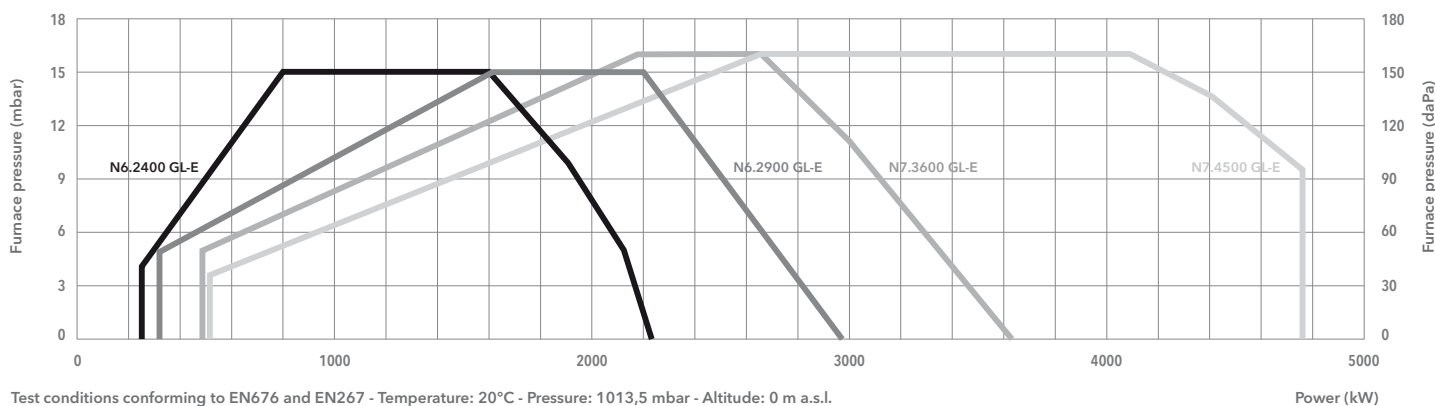

Test conditions conforming to EN676 and EN267 - Temperature: 20°C - Pressure: 1013,5 mbar - Altitude: 0 m a.s.l.

Power (kW)

	N6.2400 GL-E	N6.2900 GL-E	N7.3600 GL-E	N7.4500 GL-E
Operating range gas	250 - 2230 kW	320 - 2970 kW	490 - 3650 kW	510 - 4750 kW
Operating range oil	510 - 2030 kW	650 - 2970 kW	900 - 3650 kW	1300 - 4750 kW
Gas pressure	50 - 500 mbar (50 - 360 mbar for d452 and d453 gas train)		50 - 500 mbar (50 - 360 mbar for d452 and d453 gas train)	
Auxiliary voltage	1NPE AC 230 V - 50 Hz TN-S	1NPE AC 230 V - 50 Hz TN-S	1NPE AC 230 V - 50 Hz TN-S	1NPE AC 230 V - 50 Hz TN-S
Power supply	3PE AC 400 V - 50 Hz	3PE AC 400 V - 50 Hz	3PE AC 400 V - 50 Hz	3PE AC 400 V - 50 Hz
Control box / flame detector	BT300 / QRA2	BT300 / QRA2	BT300 / QRA2	BT300 / QRA2
Fan motor	50 Hz - 3 kW	50 Hz - 4 kW	50 Hz - 5,5 kW	50 Hz - 7,5 kW
Pump	SUNTEC TA3	SUNTEC TA3	SUNTEC TA4	SUNTEC TA4
Motor pump	50 Hz - 0,74 kW	50 Hz - 0,74 kW	50 Hz - 1,1 kW	50 Hz - 1,5 kW
Acoustic level	<70 dB(A)	<71 dB(A)	<74 dB(A)	<74 dB(A)
CE certificate	0085CL0215	0085CL0215	0085CL0215	0085CL0215
Burner body	3750560	3750573	3750586	3750599
Combustion head	KN	3750628	3750631	3750646
	KM	3750627	3750630	3750645
	KL	3750626	3750629	3750644

GAS TRAINS

DUNGS

Model	Code
GT-d452-1"1/2	3750510
GT-d453-2"	3750511
GT-d454-65	3750512
GT-d455-80	3750513
GT-d456-100	3750514

SIEMENS

Model	Code
GT-s451-1"1/2	3750525
GT-s452-2"	3750526
GT-s453-65	3750527
GT-s454-80	3750528
GT-s455-100	3750529
GT-s456-125	3750530

FILTERS

Model	Code
FG-Rp1"1/2	3750543
FG-Rp2"	3750544
FG-DN65	3750545
FG-DN80	3750546
FG-DN100	3750547
FG-DN125	3750548

 **Pressure drops graphs:** see following pages
Dimensions of gas trains and gas filters: see pag. 200



DIMENSIONS (mm)

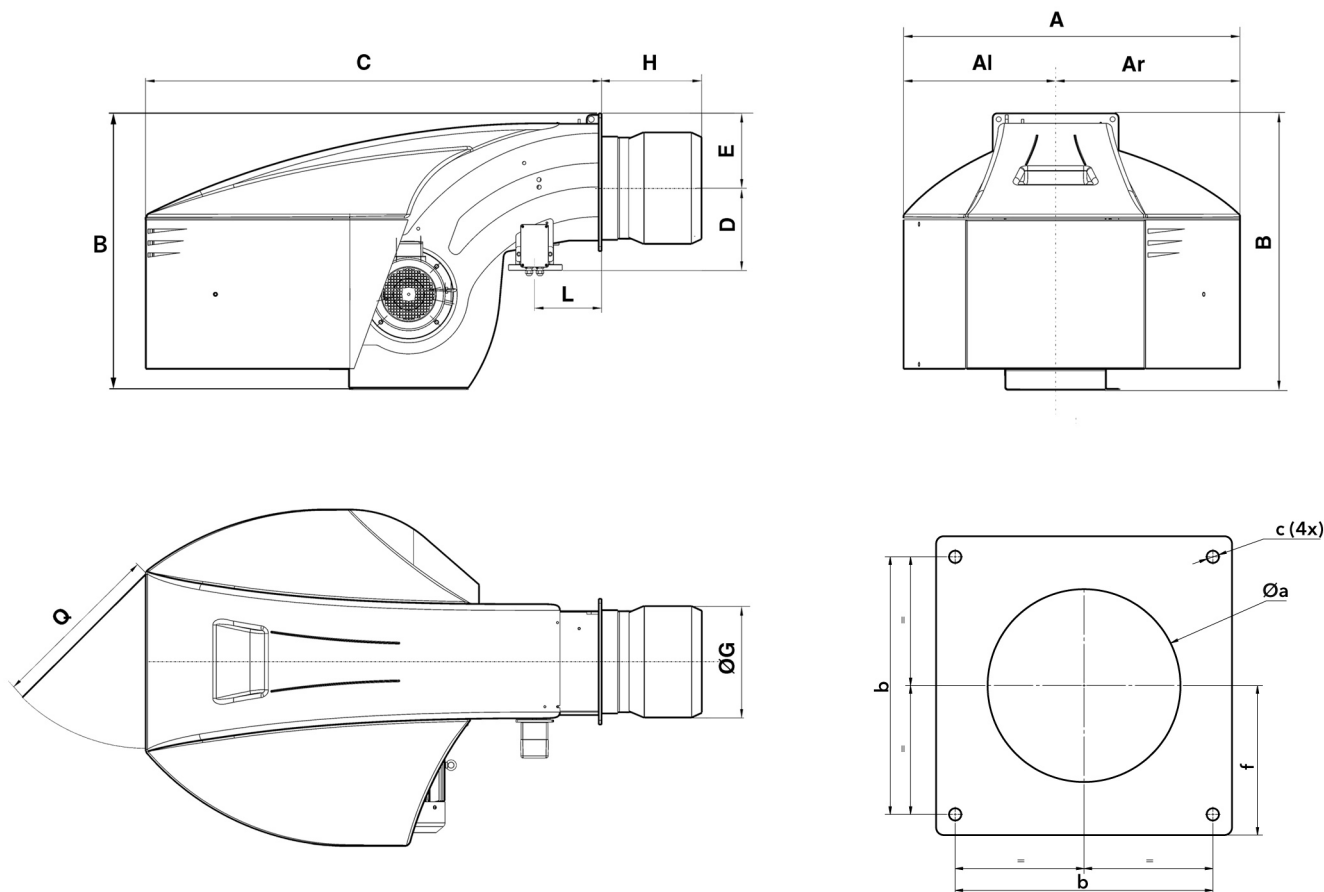

Model	A	Al	Ar	B	C	D	E	ØG	H			L	Q	Øa	b	c	f
									KN	KM	KL						
N6.2400	990	479	510	837	1361	245	225	290	330	450	570	215	600	300-340	340	M16	200
N6.2900	990	479	510	837	1361	245	225	310	330	450	570	215	600	320-340	340	M16	200
N7.3600	1128	511	618	961	1529	276	255	340	375	505	635	225	600	350-400	400	M16	235
N7.4500	1128	511	618	961	1529	276	255	370	375	505	635	225	600	380-400	400	M16	235

PACKAGING

- The burner is delivered in 2 packages containing:
- burner body with mounted combustion head, boiler fixing accessories and technical documentation;
 - gas train and filter.

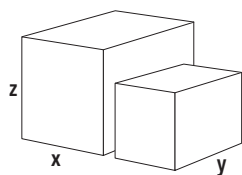

Models		Dimensions (mm)			Gross weight (kg)
		X	Y	Z	
N6.2400 GL-E	KN	1691	990	837	320
	KM	1811	990	837	320
	KL	1931	990	837	320
N6.2900 GL-E	KN	1691	990	837	330
	KM	1811	990	837	330
	KL	1931	990	837	330
N7.3600 GL-E	KN	1904	1128	961	360
	KM	2034	1128	961	360
	KL	2164	1128	961	360
N7.4500 GL-E	KN	1904	1128	961	370
	KM	2034	1128	961	370
	KL	2164	1128	961	370

PRESSURE LOSSES (BURNER HEAD + GAS TRAIN)

N6.2400 GL-E

DUNGS

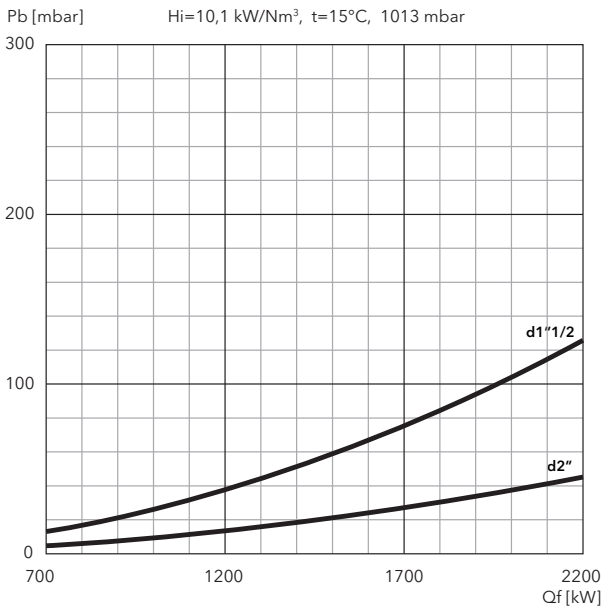

SIEMENS

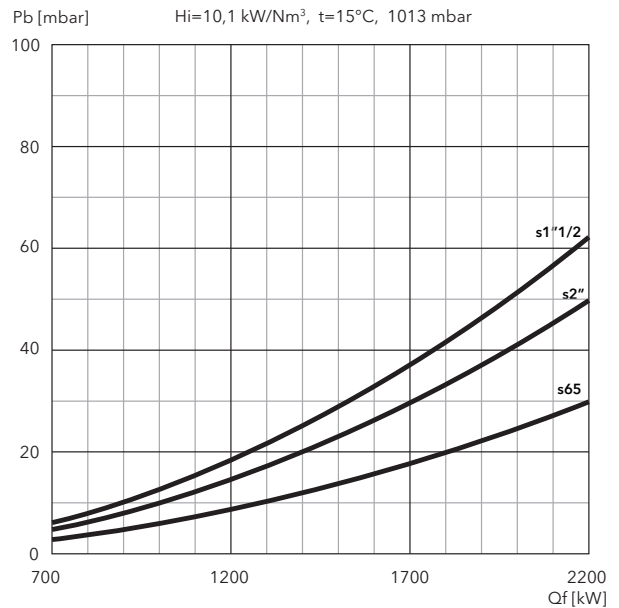

N6.2900 GL-E

DUNGS

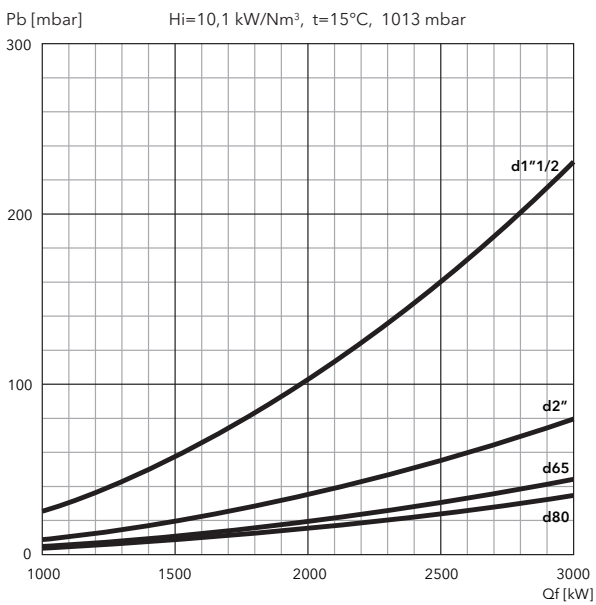

SIEMENS

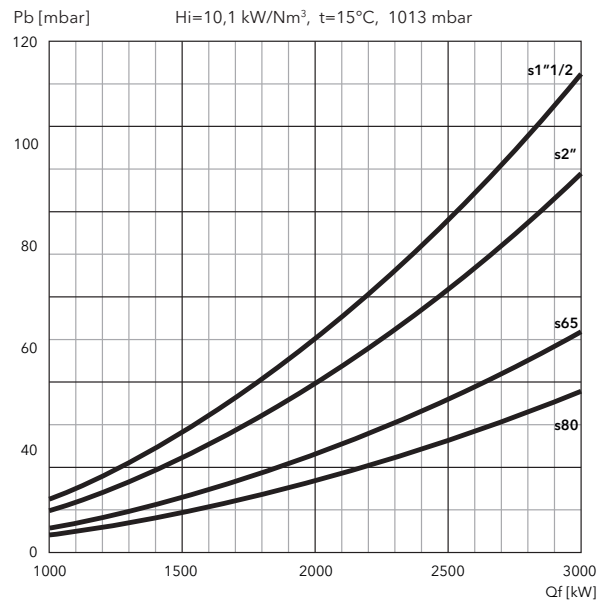

FILTERS

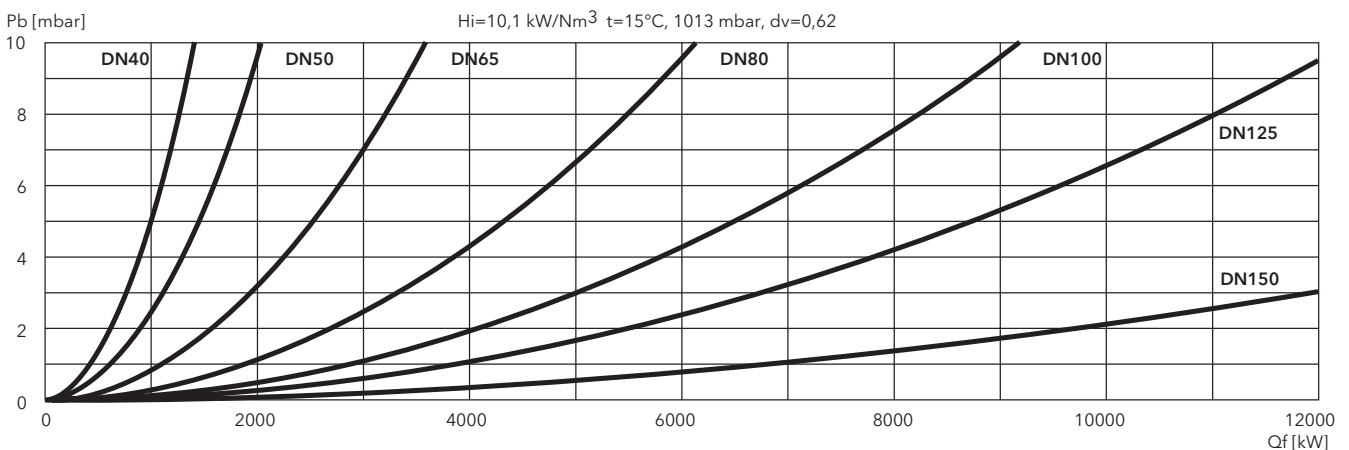

PRESSURE LOSSES (BURNER HEAD + GAS TRAIN)

N7.3600 GL-E

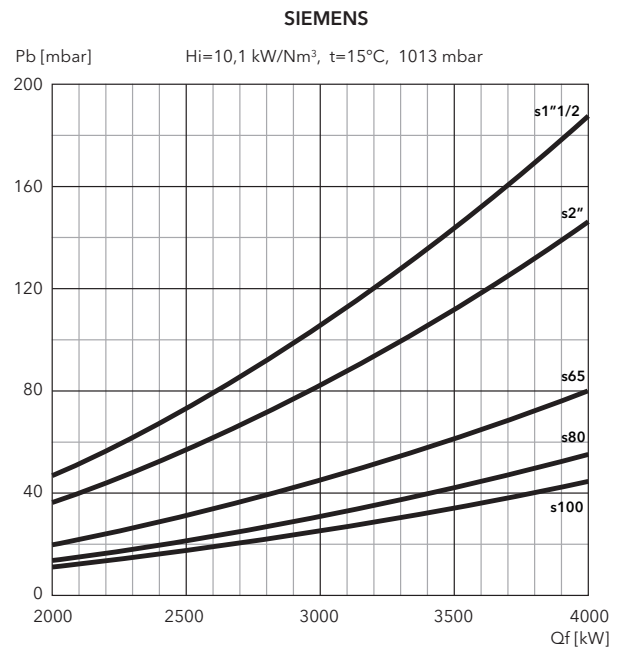
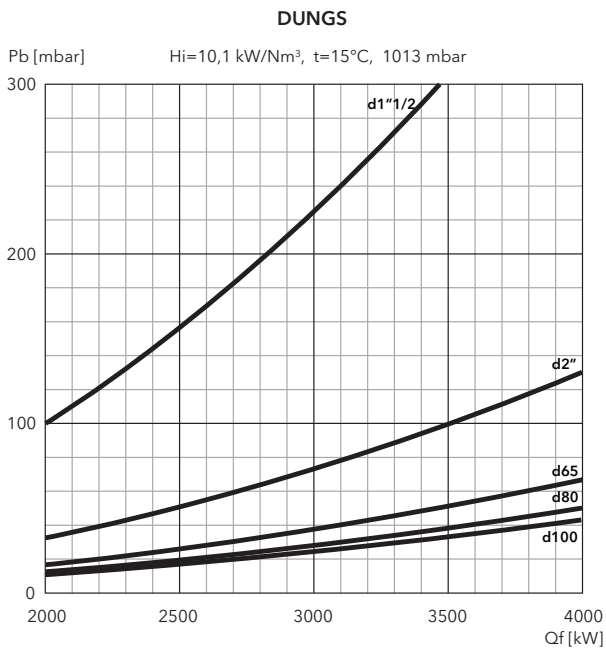

N7.4500 GL-E

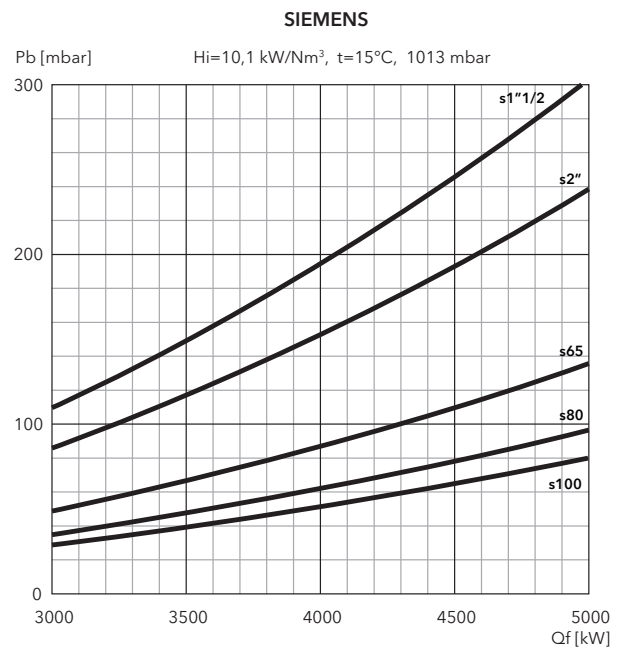
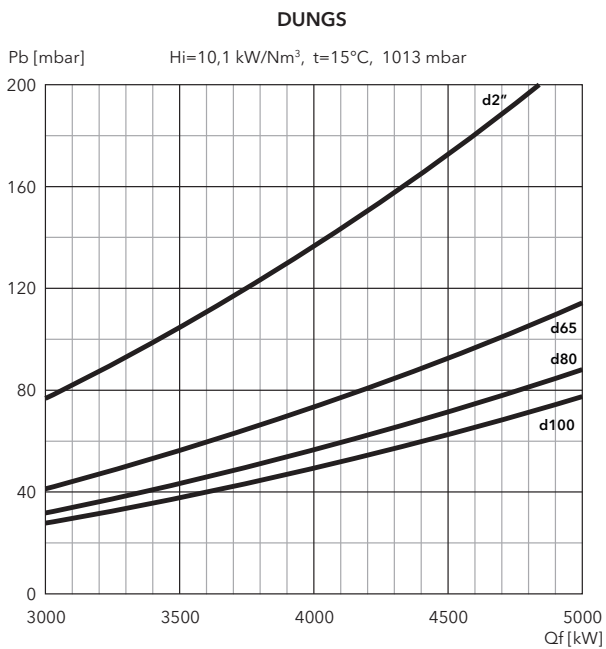

FILTERS

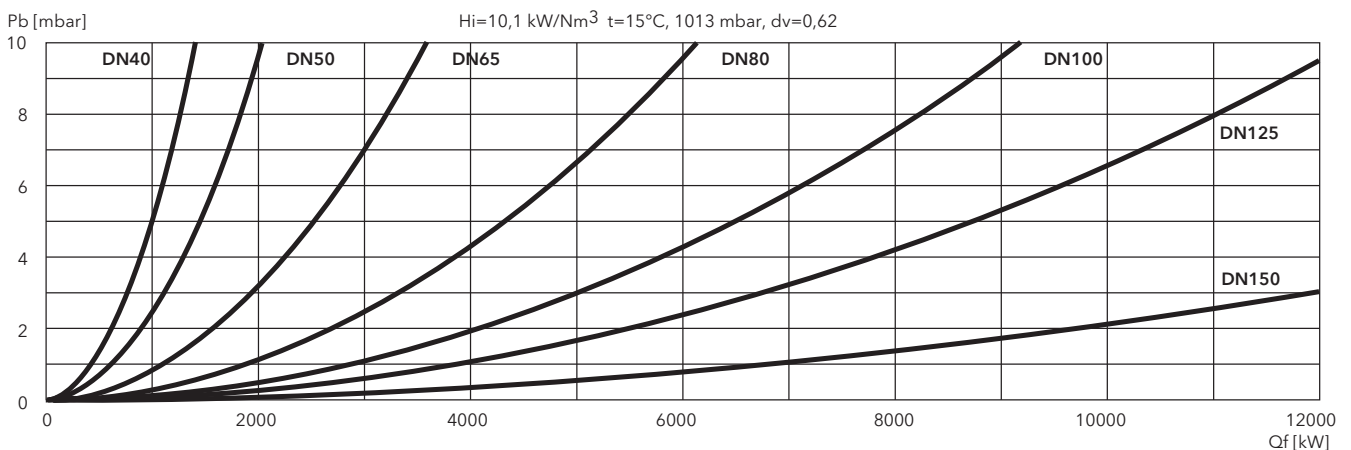

N8 GL-E, N9 GL-E

800 ... 10620 kW

2 stage progressive/modulating electronic

- **Fuels:** natural gas, low calorific value 6,99 ... 11,39 kWh/m³;
light oil, viscosity 6 mm²/s at 20°C, low calorific value 11,86 kWh/kg
- **Emission class:** Low NOx class 2 (<120 mg/kWh) according to EN676 in gas
Low NOx class 2 (<85 mg/kWh) according to EN267 in light oil
- **Electrical power supply:** single-phase 230 V - 50 Hz
- **Protection level:** IP 41



TECHNICAL DATA

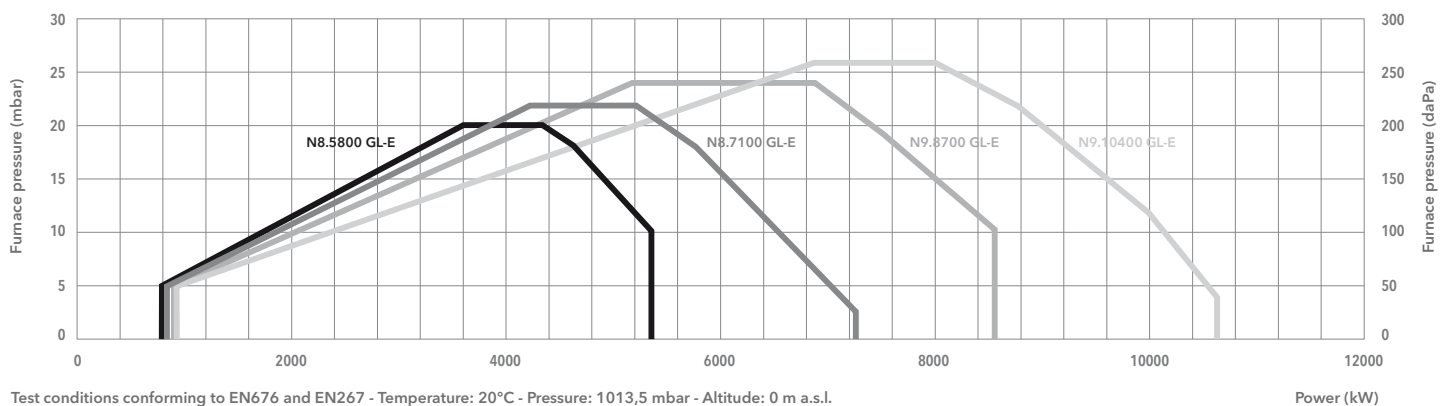

Test conditions conforming to EN676 and EN267 - Temperature: 20°C - Pressure: 1013,5 mbar - Altitude: 0 m a.s.l.

Power (kW)

	N8.5800 GL-E	N8.7100 GL-E	N9.8700 GL-E	N9.10400 GL-E
Operating range gas	790 - 5350 kW	820 - 7340 kW	880 - 8530 kW	910 - 10620 kW
Operating range oil	1210 - 5350 kW	1470 - 7340 kW	2400 - 8530 kW	2820 - 10620 kW
Gas pressure	100 - 500 mbar (100 - 360 mbar for d457 gas train)		100 - 500 mbar (100 - 360 mbar for d457 gas train)	
Auxiliary voltage	1NPE AC 230 V - 50 Hz TN-S	1NPE AC 230 V - 50 Hz TN-S	1NPE AC 230 V - 50 Hz TN-S	1NPE AC 230 V - 50 Hz TN-S
Power supply	3PE AC 400 V - 50 Hz	3PE AC 400 V - 50 Hz	3PE AC 400 V - 50 Hz	3PE AC 400 V - 50 Hz
Control box / flame detector	BT300 / QRA2	BT300 / QRA2	BT300 / QRA2	BT300 / QRA2
Fan motor	50 Hz - 11 kW	50 Hz - 15 kW	50 Hz - 18,5 kW	50 Hz - 22 kW
Pump	SMG1630 - 1700 l/h	SMG1630 - 1700 l/h	SMG1630 - 1700 l/h	SMG1631 - 2200 l/h
Motor pump	50 Hz - 3 kW	50 Hz - 3 kW	50 Hz - 3 kW	50 Hz - 4 kW
Acoustic level	<77,4 dB(A)	<79,5 dB(A)	<81 dB(A)	<81,7 dB(A)
CE certificate	0085CL0215	0085CL0215	0085CL0215	0085CL0215
Burner body	3750610	3750614	3750622	3750618
Combustion head	KN	3750664	3750676	3750679
	KM	3750663	3750666	3750678
	KL	3750662	3750665	3750677

GAS TRAINS

DUNGS

Model	Code
GT-d457-2"	3750515
GT-d458-65	3750516
GT-d459-80	3750517
GT-d460-100	3750518

SIEMENS

Model	Code
GT-s457-2"	3750537
GT-s458-65	3750538
GT-s459-80	3750539
GT-s460-100	3750540
GT-s461-125	3750541

 **Pressure drops graphs:** see following pages
Dimensions of gas trains and gas filters: see pag. 201



DIMENSIONS (mm)

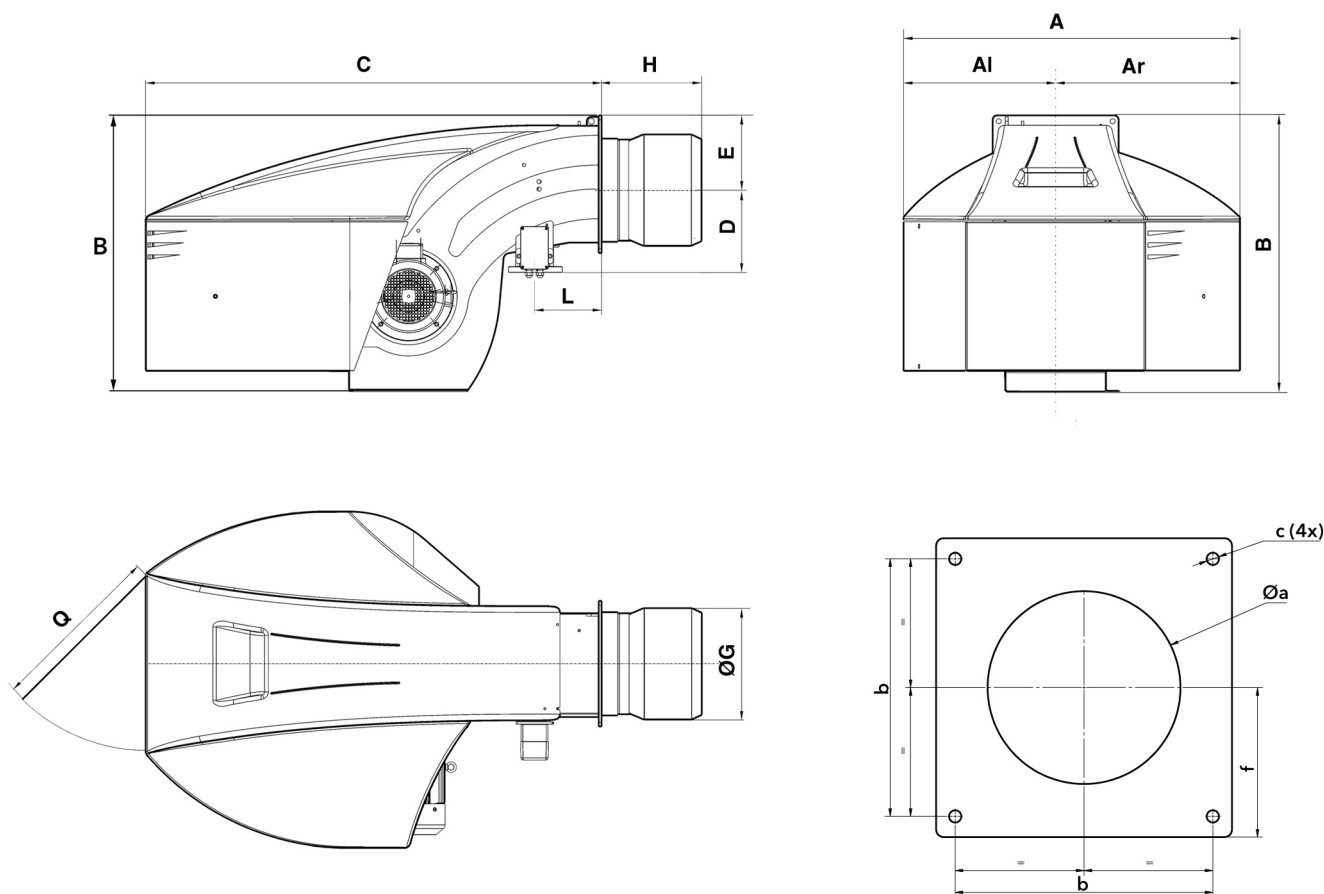

Model	A	Al	Ar	B	C	D	E	ØG	H			L	Q	Øa	b	c	f
									KN	KM	KL						
N8.5800	1414	669	745	1231	1930	391	293	400	562	702	842	230	800	430-480	505	M20	293
N8.7100	1414	669	745	1231	1930	391	293	415	583	723	863	230	800	445-480	505	M20	293
N9	1414	669	745	1291	1928	434	293	431,5	355	505	655	230	800	445-480	505	M20	293

PACKAGING

- The burner is delivered in 2 packages containing:
- burner body with mounted combustion head, boiler fixing accessories and technical documentation;
 - gas train and filter.

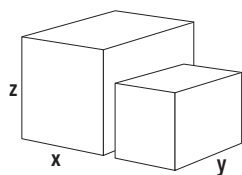

Models		Dimensions (mm)			Gross weight (kg)
		X	Y	Z	
N8.5800 GL-E	KN	2582	1414	1231	638
	KM	2632	1414	1231	647
	KL	2772	1414	1231	653
N8.7100 GL-E	KN	2513	1414	1231	640
	KM	2653	1414	1231	649
	KL	2793	1414	1231	655
N9.8700 GL-E	KN	2283	1414	1291	662
	KM	2433	1414	1291	669
	KL	2583	1414	1291	677
N9.10400 GL-E	KN	2283	1414	1291	672
	KM	2433	1414	1291	679
	KL	2583	1414	1291	687

PRESSURE LOSSES (BURNER HEAD + GAS TRAIN)

N8.5800 GL-E

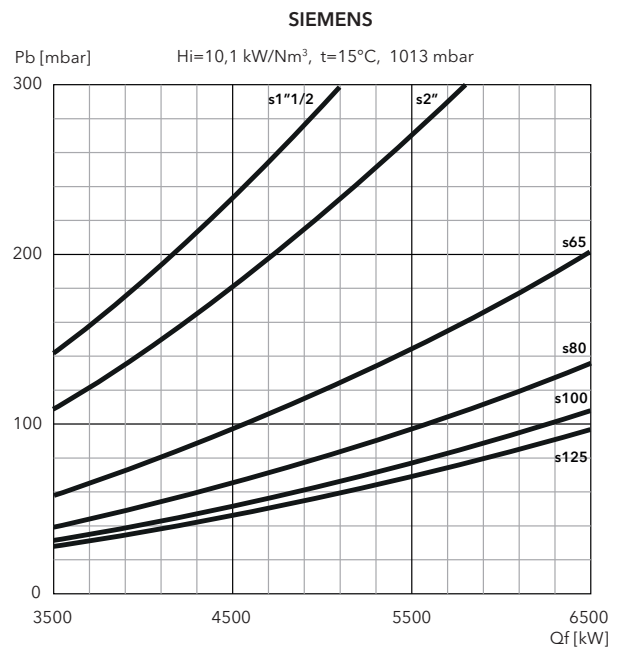
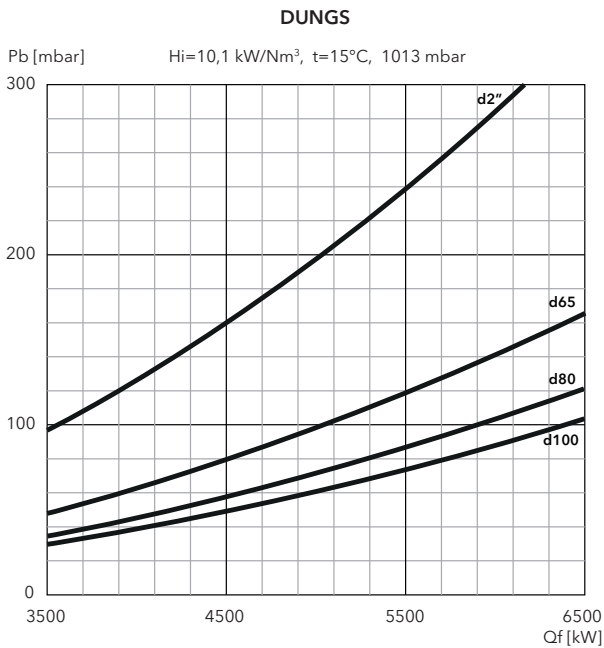

N8.7100 GL-E

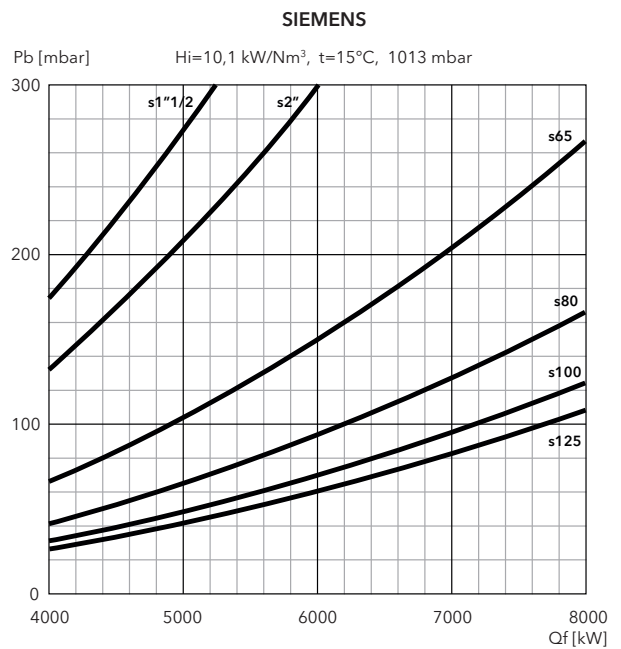
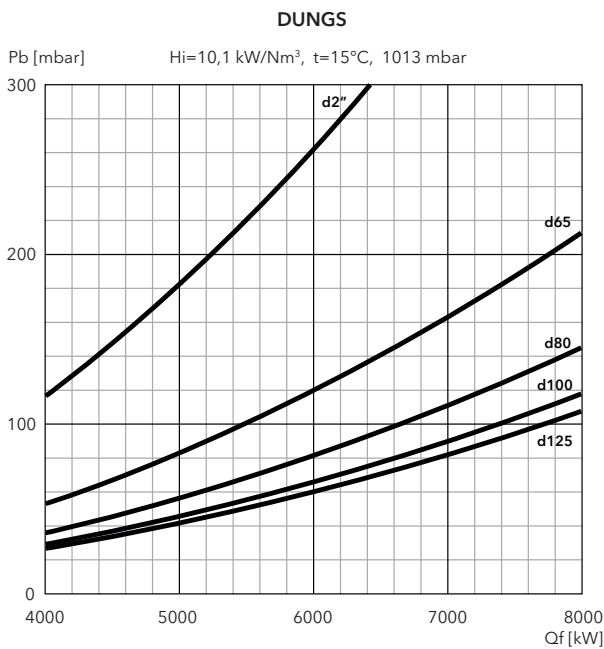

FILTERS

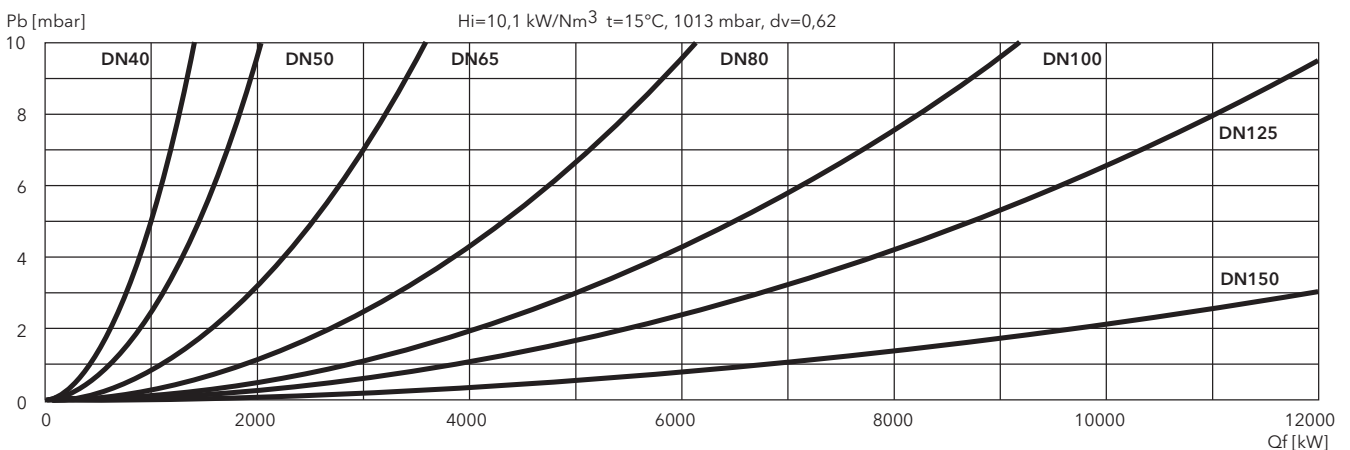

PRESSURE LOSSES (BURNER HEAD + GAS TRAIN)

N9.8700 GL-E

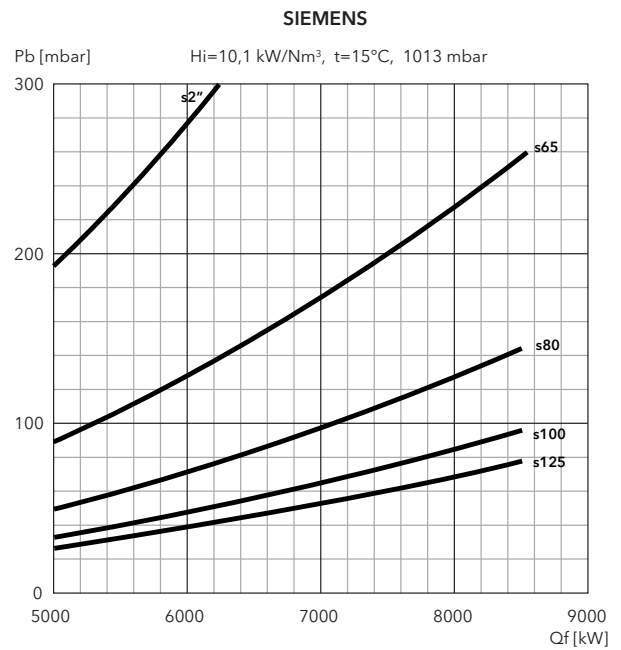
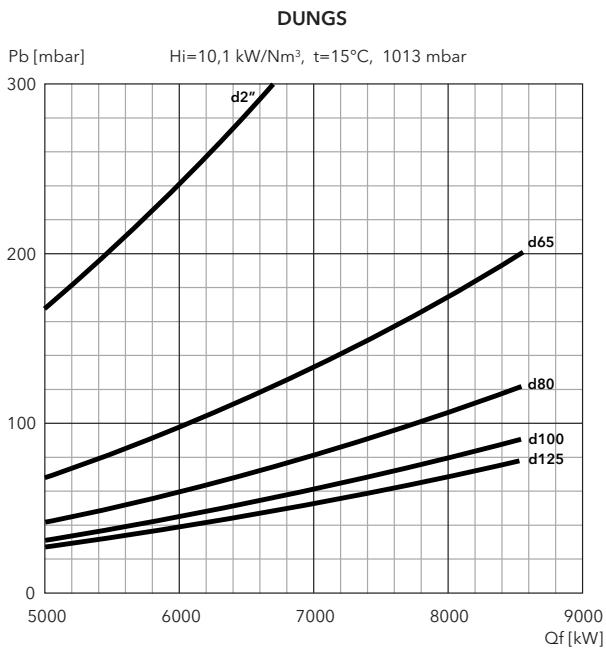

N9.10400 GL-E

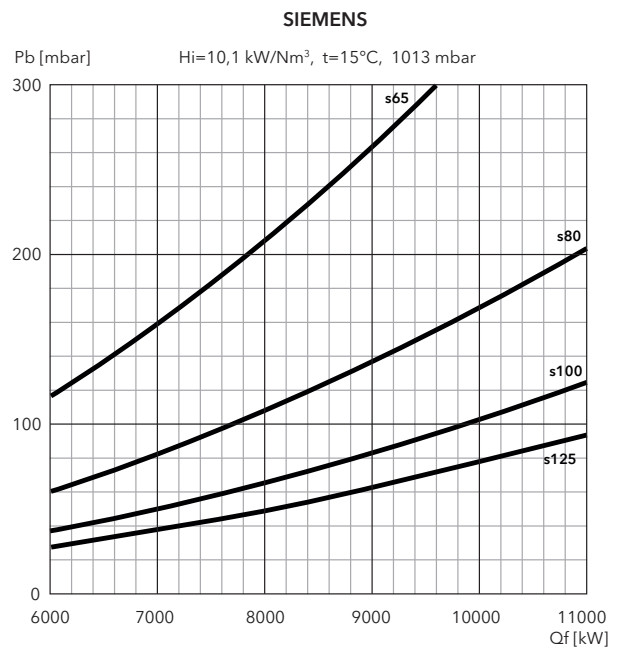
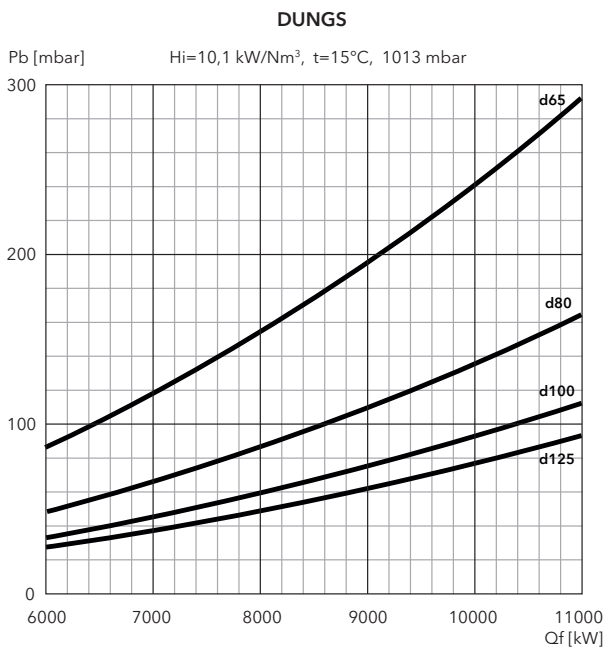

FILTERS

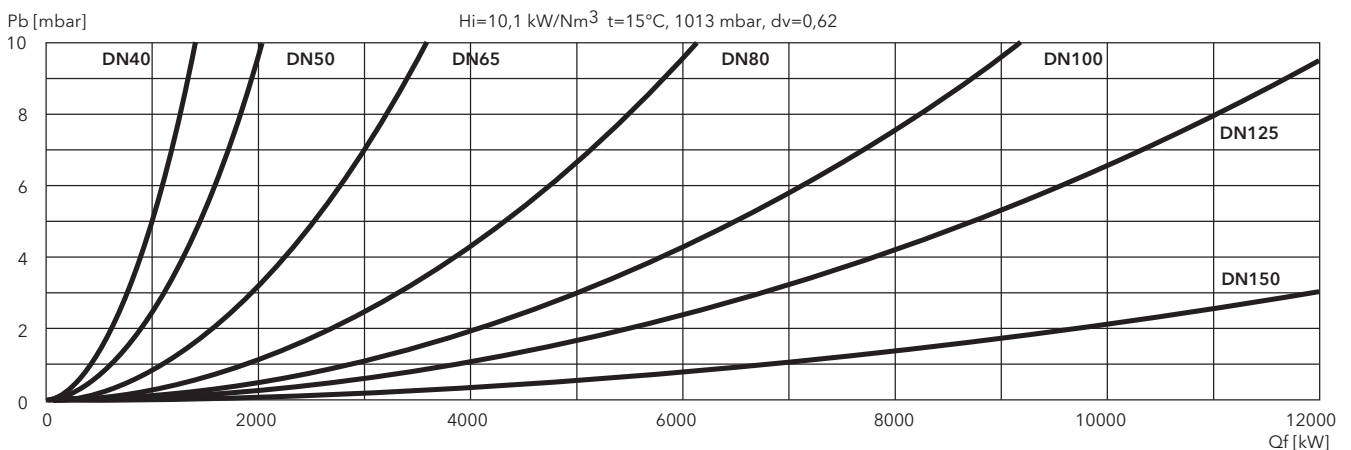

N6 GL-EF3, N7 GL-EF3

280 ... 4500 kW

2 stage progressive/modulating electronic (Low NOx class 3)

- **Fuels:** natural gas, low calorific value 6,99 ... 11,39 kWh/m³;
light oil, viscosity 6 mm²/s at 20°C, low calorific value 11,86 kWh/kg
- **Emission class:** Low NOx class 3 (<80 mg/kWh) according to EN676 in gas
Low NOx class 3 (<120 mg/kWh) according to EN267 in light oil
- **Electrical power supply:** single-phase 230 V - 50 Hz
- **Protection level:** IP 41



TECHNICAL DATA

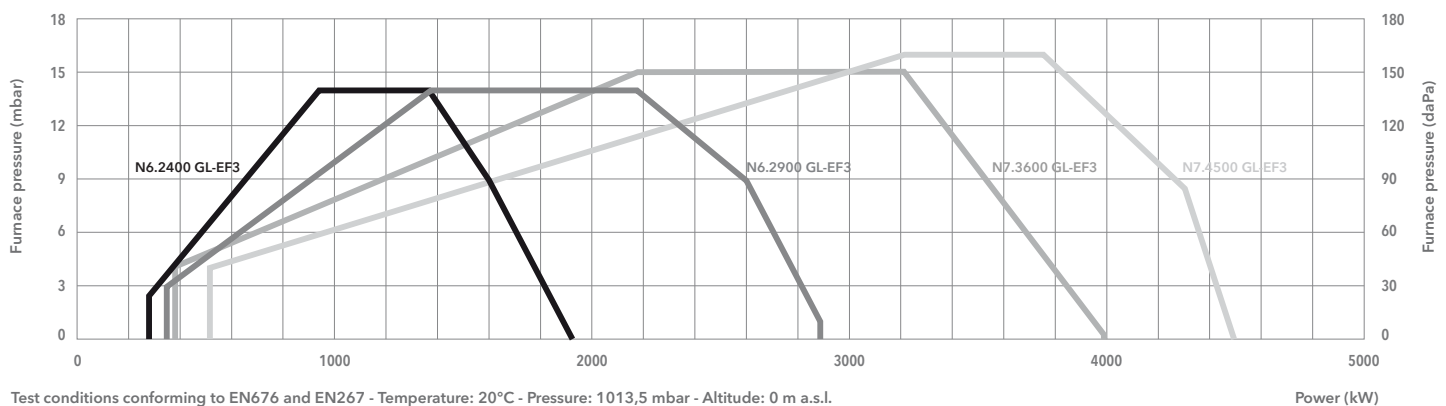

Test conditions conforming to EN676 and EN267 - Temperature: 20°C - Pressure: 1013,5 mbar - Altitude: 0 m a.s.l.

Power (kW)

	N6.2400 GL-EF3	N6.2900 GL-EF3	N7.3600 GL-EF3	N7.4500 GL-EF3
Operating range gas	280 - 1920 kW	340 - 2890 kW	470 - 3980 kW	510 - 4500 kW
Operating range oil	360 - 1920 kW	740 - 2890 kW	680 - 3980 kW	740 - 4500 kW
Gas pressure	50 - 500 mbar (50 - 360 mbar for d452 and d453 gas train)		50 - 500 mbar (50 - 360 mbar for d452 and d453 gas train)	
Auxiliary voltage	1NPE AC 230 V - 50 Hz TN-S	1NPE AC 230 V - 50 Hz TN-S	1NPE AC 230 V - 50 Hz TN-S	1NPE AC 230 V - 50 Hz TN-S
Power supply	3PE AC 400 V - 50 Hz	3PE AC 400 V - 50 Hz	3PE AC 400 V - 50 Hz	3PE AC 400 V - 50 Hz
Control box / flame detector	BT300 / D-LX 100 EK-S	BT300 / D-LX 100 EK-S	BT300 / D-LX 100 EK-S	BT300 / D-LX 100 EK-S
Fan motor	50 Hz - 3 kW	50 Hz - 4 kW	50 Hz - 7,5 kW	50 Hz - 7,5 kW
Pump	SUNTEC TA3	SUNTEC TA3	SUNTEC TA4	SUNTEC TA4
Motor pump	50 Hz - 0,74 kW	50 Hz - 0,74 kW	50 Hz - 1,1 kW	50 Hz - 1,5 kW
Acoustic level	<71 dB(A)	<71 dB(A)	<76 dB(A)	<74 dB(A)
CE certificate	0085CL0215	0085CL0215	0085CL0215	0085CL0215
Burner body	3750561	3750574	3750587	3750600
Combustion head	KN	3750634	3750652	3750655
	KM	3750633	3750636	3750654
	KL	3750632	3750635	3750653

GAS TRAINS

DUNGS

Model	Code
GT-d451-1"1/4	3750509
GT-d452-1"1/2	3750510
GT-d453-2"	3750511
GT-d454-65	3750512
GT-d455-80	3750513
GT-d456-100	3750514

SIEMENS

Model	Code
GT-s451-1"1/2	3750525
GT-s452-2"	3750526
GT-s453-65	3750527
GT-s454-80	3750528
GT-s455-100	3750529
GT-s456-125	3750530

FILTERS

Model	Code
FG-Rp1"1/2	3750543
FG-Rp2"	3750544
FG-DN65	3750545
FG-DN80	3750546
FG-DN100	3750547
FG-DN125	3750548

 **Pressure drops graphs:** see following pages
Dimensions of gas trains and gas filters: see pag. 200



DIMENSIONS (mm)

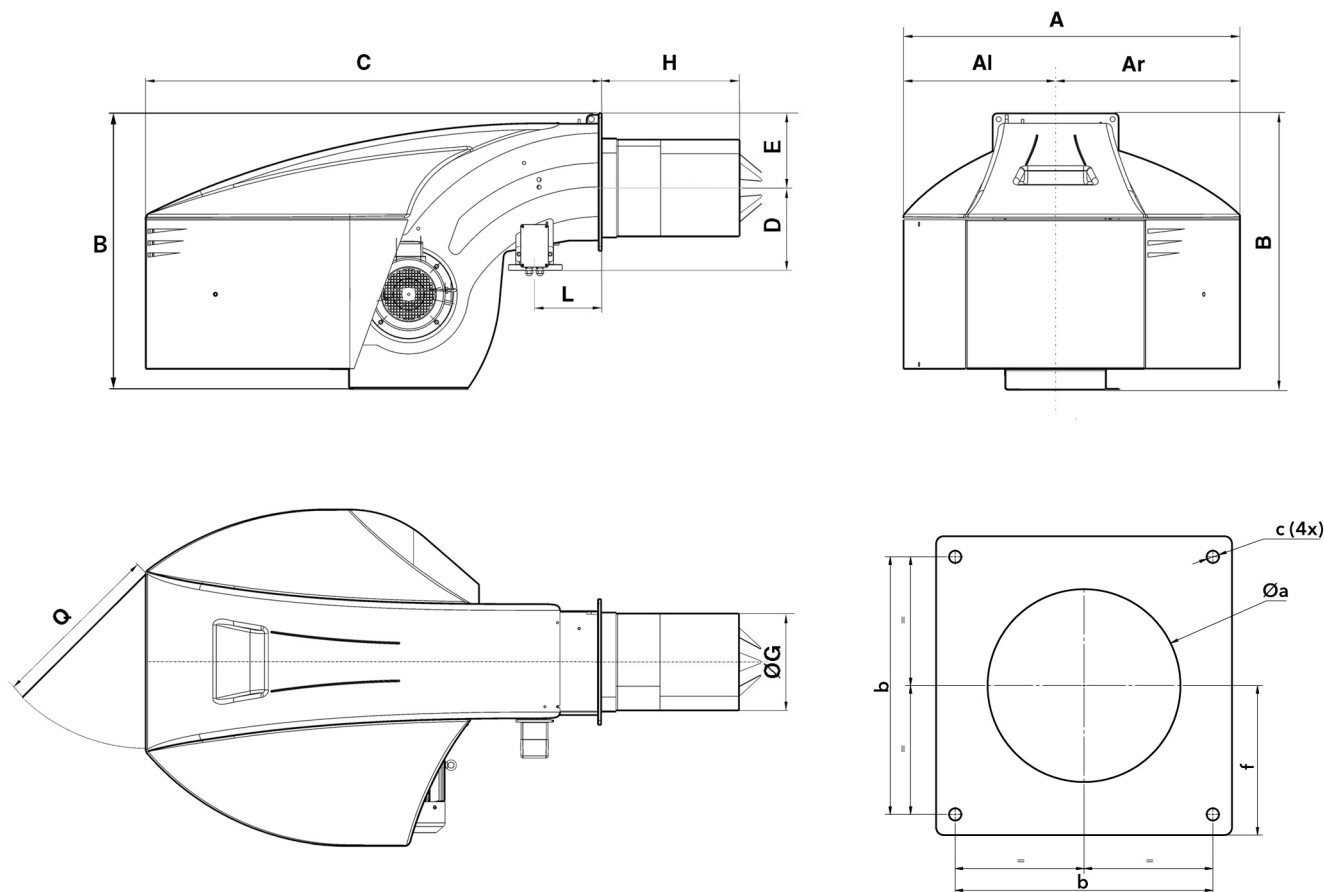

Model	A	Al	Ar	B	C	D	E	ØG	H			L	Q	Øa	b	c	f
									KN	KM	KL						
N6	990	479	510	837	1361	245	225	264	400	520	640	215	600	300-340	340	M16	200
N7	1128	511	618	961	1529	276	255	325	420	550	680	225	600	360-400	400	M16	235

PACKAGING

- The burner is delivered in 2 packages containing:
- burner body with mounted combustion head, boiler fixing accessories and technical documentation;
 - gas train and filter.

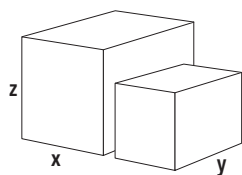

Models		Dimensions (mm)			Gross weight (kg)
		X	Y	Z	
N6.2400 GL-EF3	KN	1861	990	837	320
	KM	1981	990	837	320
	KL	2101	990	837	320
N6.2900 GL-EF3	KN	1861	990	837	330
	KM	1981	990	837	330
	KL	2101	990	837	330
N7.3600 GL-EF3	KN	2029	1128	961	360
	KM	2179	1128	961	360
	KL	2309	1128	961	360
N7.4500 GL-EF3	KN	2029	1128	961	370
	KM	2179	1128	961	370
	KL	2309	1128	961	370

PRESSURE LOSSES (BURNER HEAD + GAS TRAIN)

N6.2400 GL-EF3

DUNGS

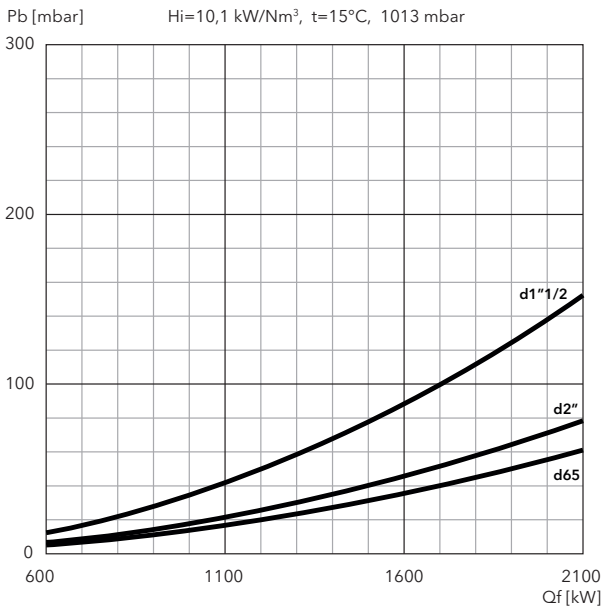

SIEMENS

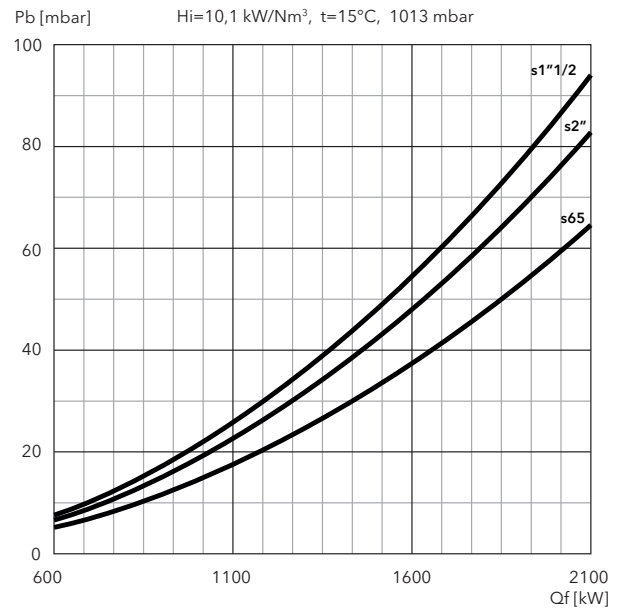

N6.2900 GL-EF3

DUNGS

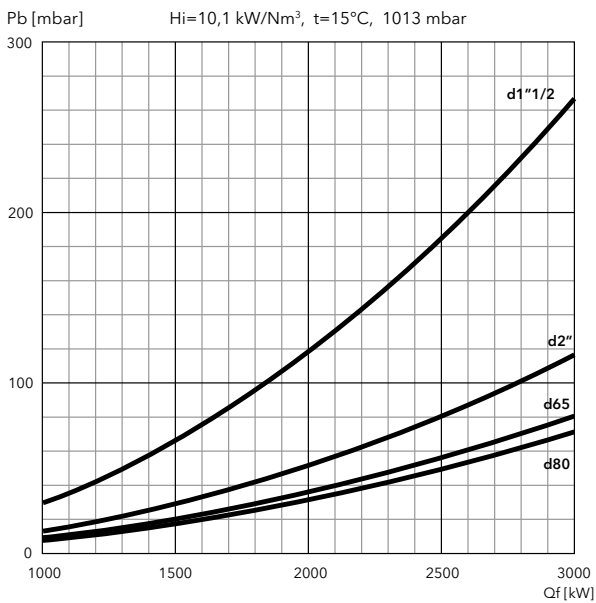

SIEMENS

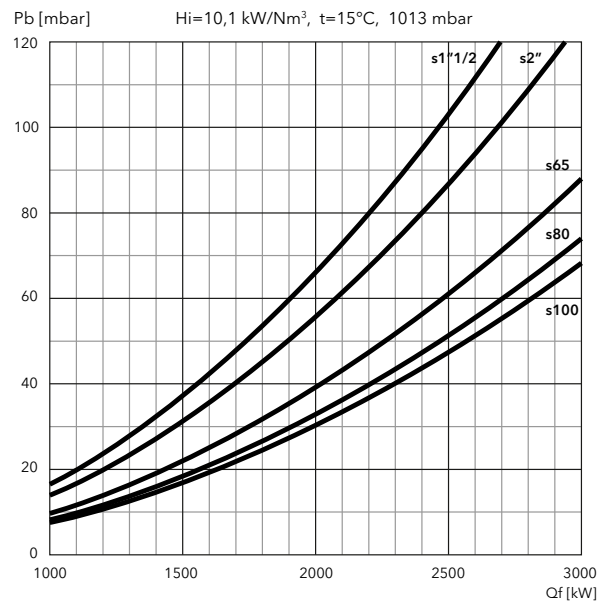

FILTERS

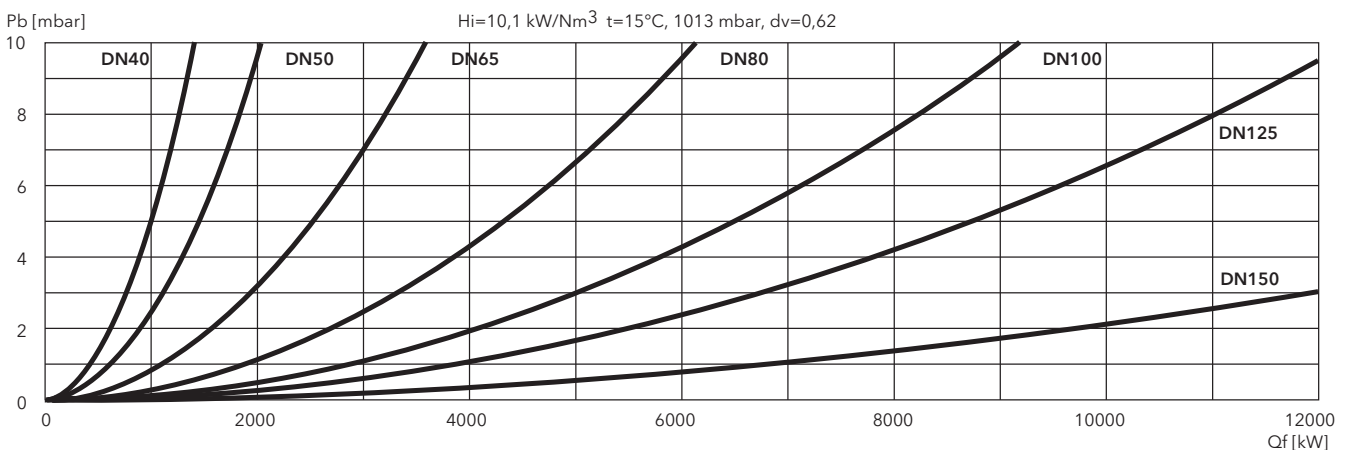

PRESSURE LOSSES (BURNER HEAD + GAS TRAIN)

N7.3600 GL-EF3

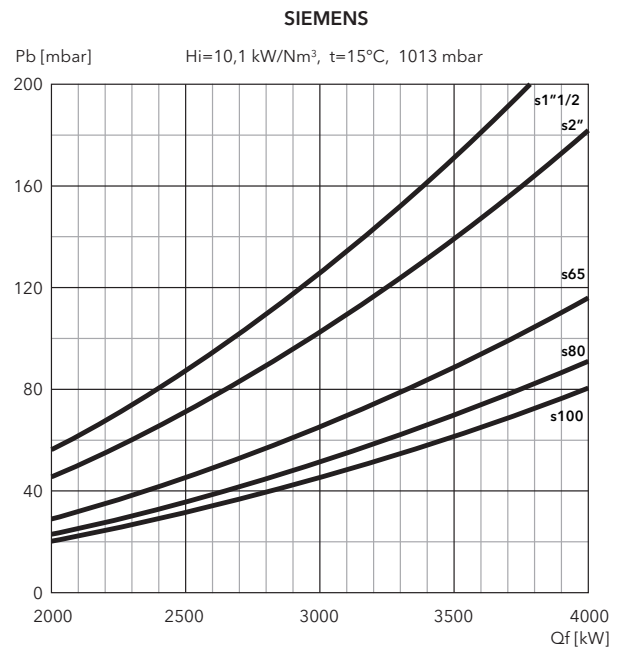
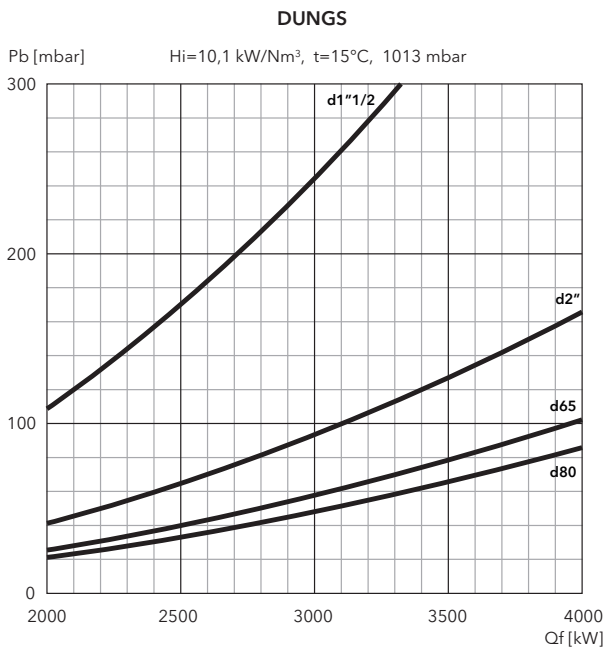

N7.4500 GL-EF3

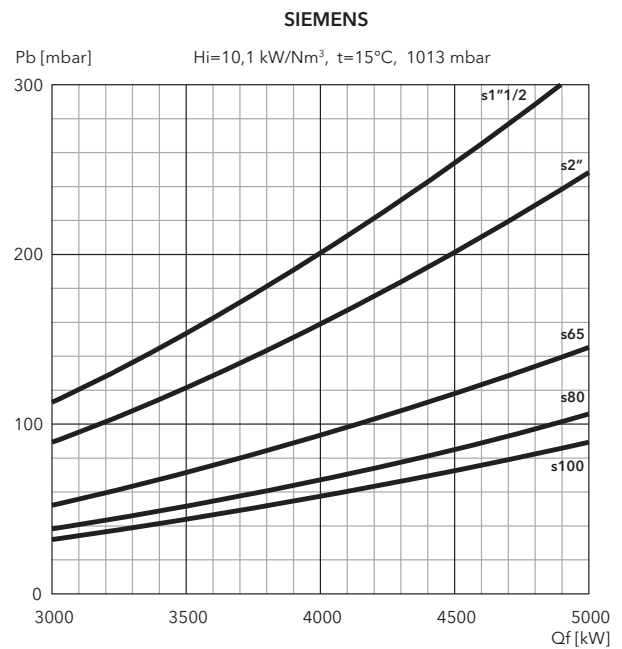

FILTERS

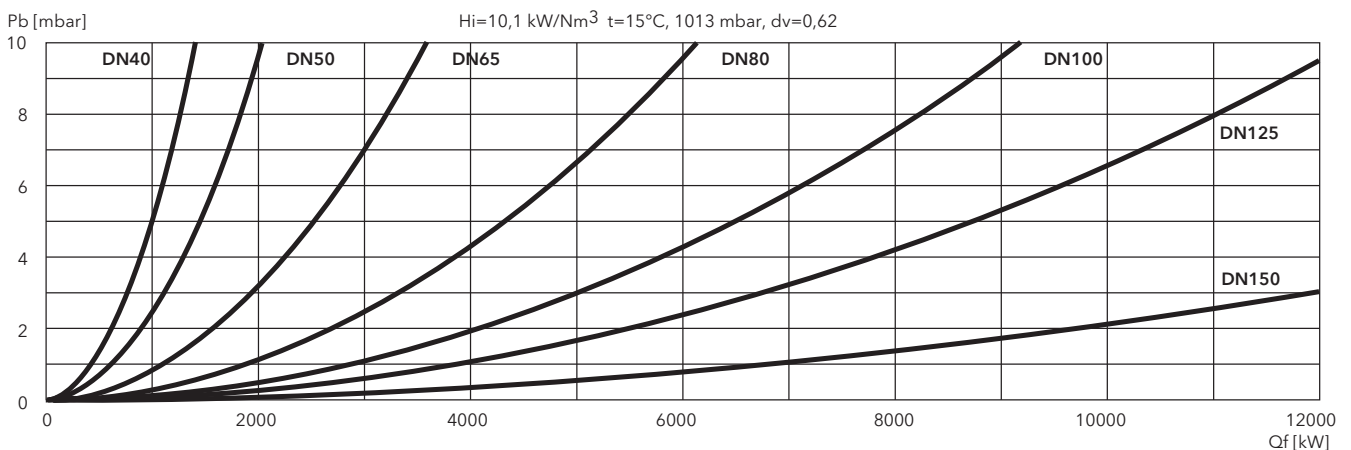

N8/N9 GL-EF3, N9 GL-EUF

830 ... 9570 kW

2 stage progressive/modulating electronic (Low NOx class 3)

- **Fuels:** natural gas, low calorific value 6,99 ... 11,39 kWh/m³;
light oil, viscosity 6 mm²/s at 20°C, low calorific value 11,86 kWh/kg
- **Emission class:** Low NOx class 3 (<80 mg/kWh) according to EN676 in gas
Low NOx class 3 (<120 mg/kWh) according to EN267 in light oil
- **Electrical power supply:** single-phase 230 V - 50 Hz
- **Protection level:** IP 41



TECHNICAL DATA

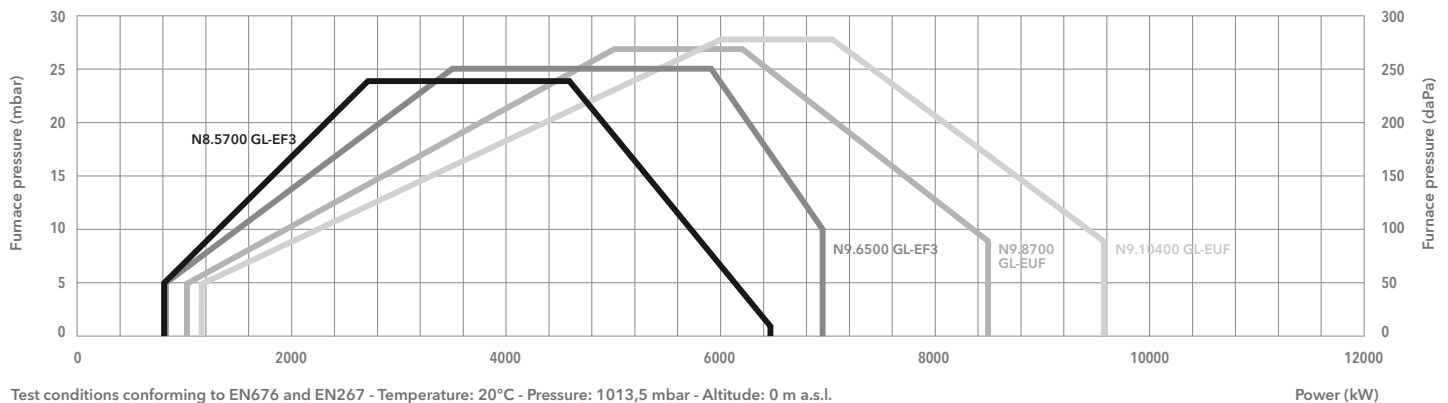

Test conditions conforming to EN676 and EN267 - Temperature: 20°C - Pressure: 1013,5 mbar - Altitude: 0 m a.s.l.

Power (kW)

	N8.5700 GL-EF3	N9.6500 GL-EF3	N9.8700 GL-EUF	N9.10400 GL-EUF
Operating range gas	830 - 6450 kW	830 - 6950 kW	1040 - 8500 kW	1160 - 9570 kW
Operating range oil	1030 - 6450 kW	1030 - 6600 kW	1800 - 8500 kW	2550 - 9570 kW
Gas pressure	100 - 500 mbar (100 - 360 mbar for d457 gas train)		100 - 500 mbar (100 - 360 mbar for d457 gas train)	
Auxiliary voltage	1NPE AC 230 V - 50 Hz TN-S	1NPE AC 230 V - 50 Hz TN-S	1NPE AC 230 V - 50 Hz TN-S	1NPE AC 230 V - 50 Hz TN-S
Power supply	3PE AC 400 V - 50 Hz	3PE AC 400 V - 50 Hz	3PE AC 400 V - 50 Hz	3PE AC 400 V - 50 Hz
Control box / flame detector	BT300 / Satronic 1020	BT300 / Satronic 1020	BT300 / D-LX 100 EK-S	BT300 / D-LX 100 EK-S
Fan motor	50 Hz - 15 kW	50 Hz - 22 kW	50 Hz - 18,5 kW	50 Hz - 22 kW
Pump	SMG1630 - 1700 l/h	SMG1630 - 1700 l/h	SMG1630 - 1700 l/h	SMG1631 - 2200 l/h
Motor pump	50 Hz - 3 kW	50 Hz - 3 kW	50 Hz - 3 kW	50 Hz - 4 kW
Acoustic level	<80 dB(A)	<83 dB(A)	<81 dB(A)	<81,7 dB(A)
CE certificate	0085CL0215	0085CL0215	0085CL0215	0085CL0215
Burner body	3751388	3751389	3751472	3751473
Combustion head	KN 3750673	3750685	3751476	3751479
	KM 3750672	3750684	3751477	3751480
	KL 3750671	3750683	3751478	3751481

GAS TRAINS

DUNGS

Model	Code
GT-d457-2"	3750515
GT-d458-65	3750516
GT-d459-80	3750517
GT-d460-100	3750518

SIEMENS

Model	Code
GT-s457-2"	3750537
GT-s458-65	3750538
GT-s459-80	3750539
GT-s460-100	3750540
GT-s461-125	3750541

FILTERS

Model	Code
FG-Rp2"	3750544
FG-DN65	3750545
FG-DN80	3750546
FG-DN100	3750547
FG-DN125	3750548

 **Pressure drops graphs:** see following pages
Dimensions of gas trains and gas filters: see pag. 201



DIMENSIONS (mm)

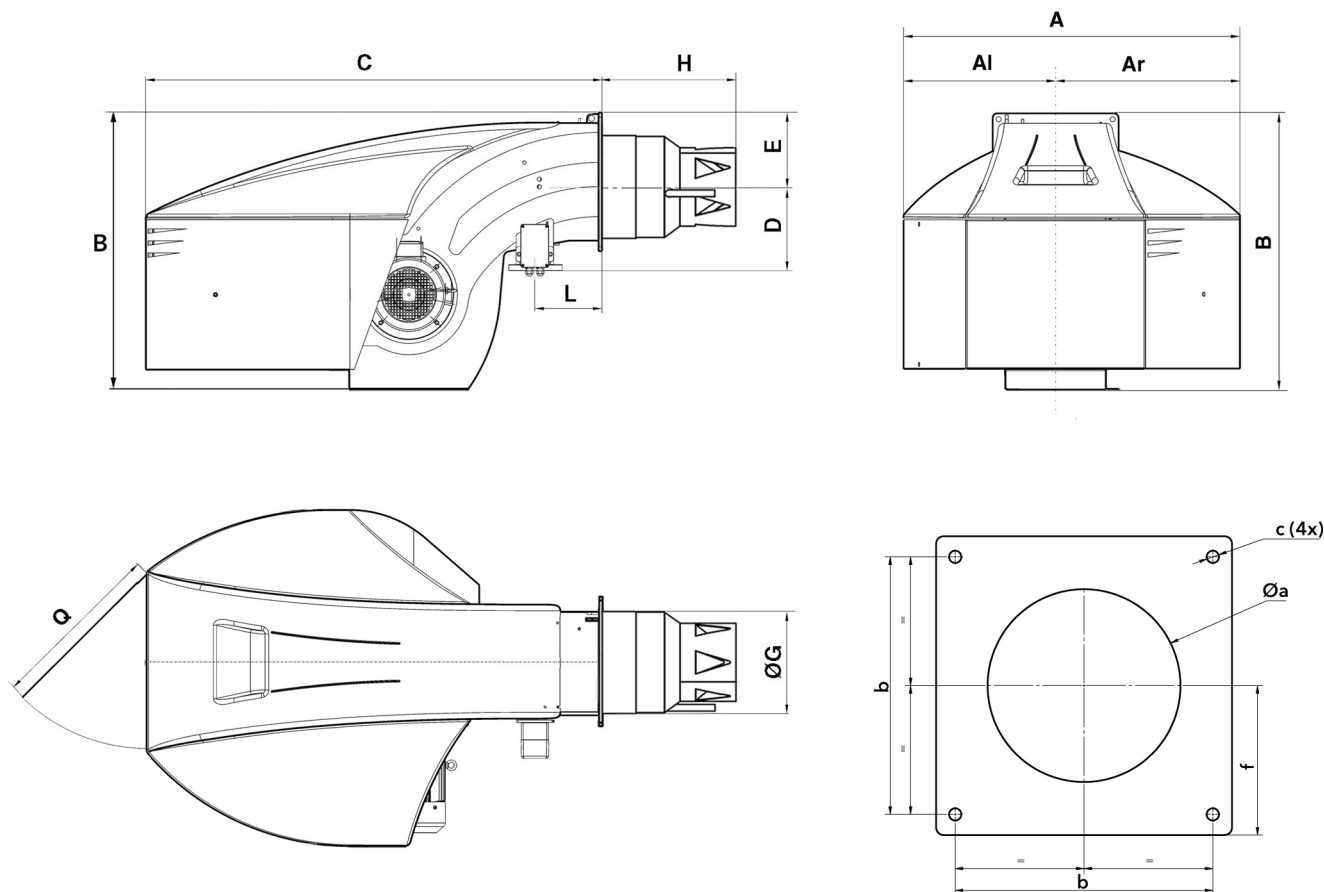

Model	A	Al	Ar	B	C	D	E	ØG	H			L	Q	Øa	b	c	f
									KN	KM	KL						
N8.5700	1414	669	745	1231	1930	391	293	369	528	668	808	230	800	380-410	505	M20	293
N9.6500	1414	669	745	1291	1928	434	293	431,5	543	693	843	230	800	445-480	505	M20	293
N9 GL-EUF	1414	669	745	1291	1928	434	293	431,5	575	725	875	230	800	445-480	505	M20	293

PACKAGING

- The burner is delivered in 2 packages containing:
- burner body with mounted combustion head, boiler fixing accessories and technical documentation;
 - gas train and filter.

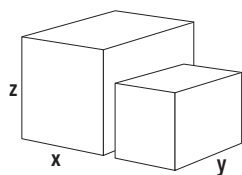

Models		Dimensions (mm)			Gross weight (kg)
		X	Y	Z	
N8.5700 GL-EF3	KN	2530	1414	1231	600
	KM	2670	1414	1231	608
	KL	2810	1414	1231	615
N9.6500 GL-EF3	KN	2550	1414	1291	670
	KM	2700	1414	1291	678
	KL	2850	1414	1291	685
N9.8700 GL-EUF	KN	2503	1414	1291	662
	KM	2653	1414	1291	670
	KL	2803	1414	1291	677
N9.10400 GL-EUF	KN	2503	1414	1291	672
	KM	2653	1414	1291	680
	KL	2803	1414	1291	687

PRESSURE LOSSES (BURNER HEAD + GAS TRAIN)

N8.5700 GL-EF3

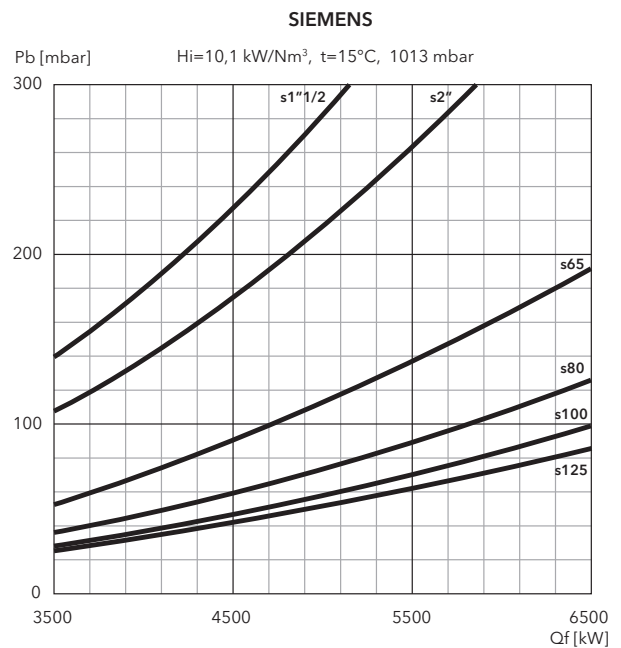
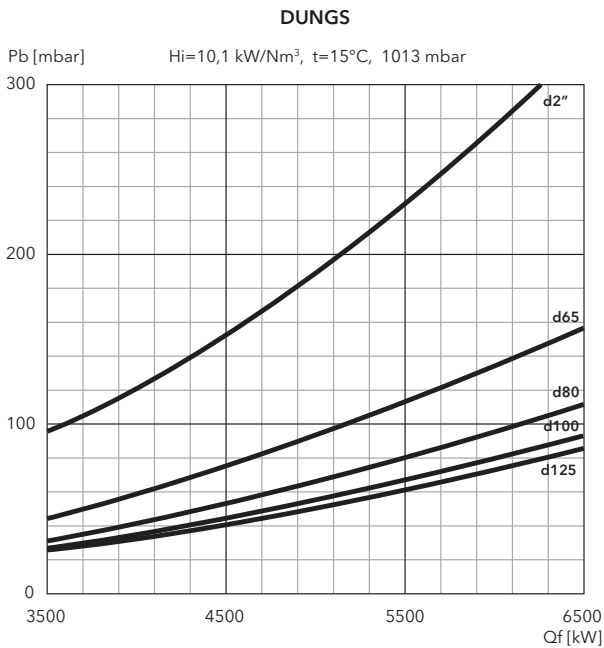

N9.6500 GL-EF3

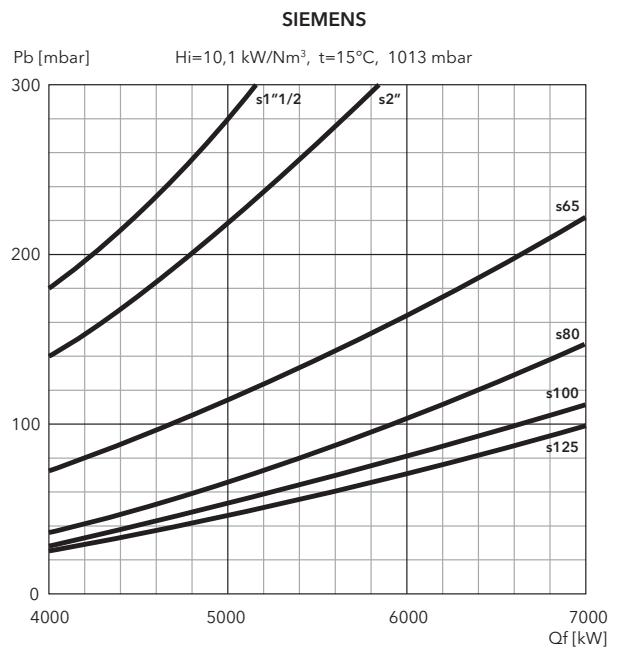
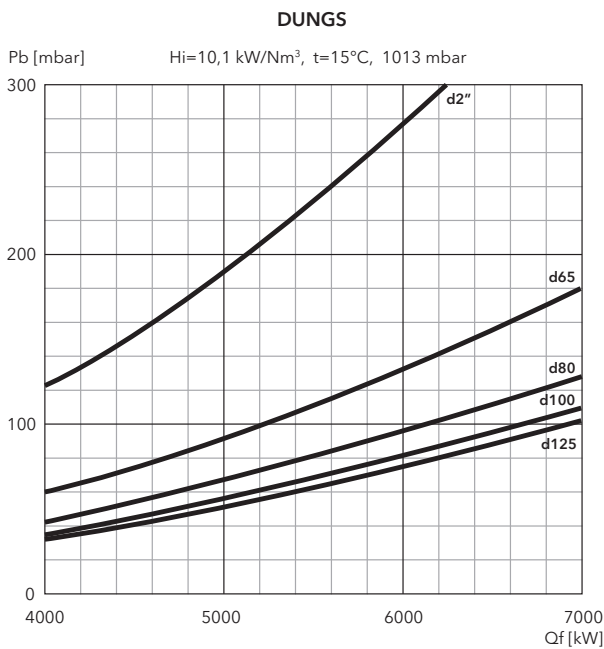

FILTERS

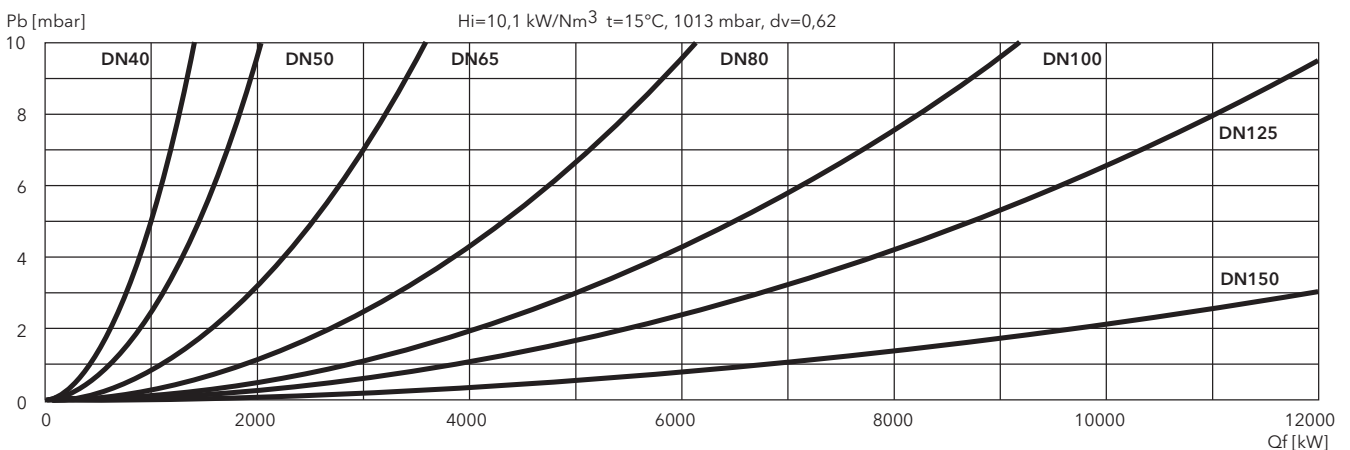

PRESSURE LOSSES (BURNER HEAD + GAS TRAIN)

N9.8700 GL-EUF

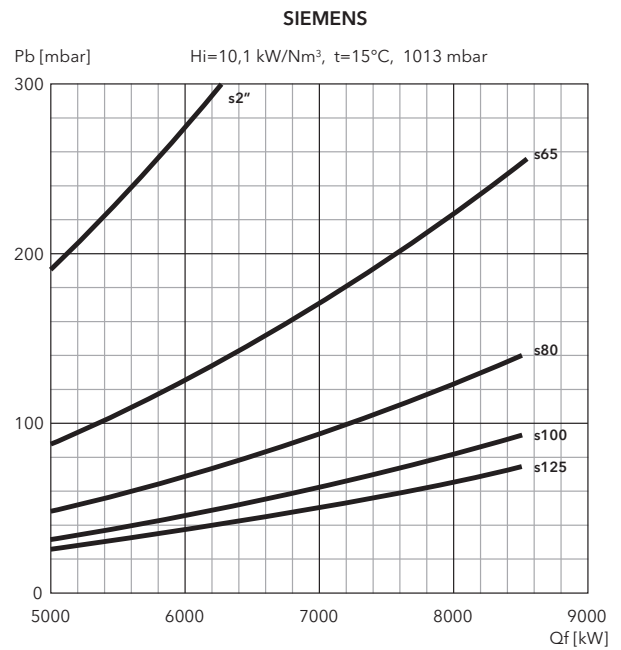
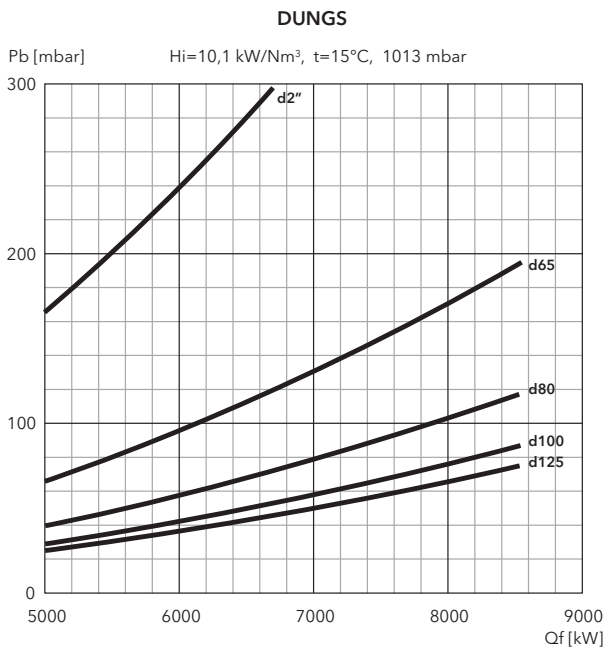

N9.10400 GL-EUF

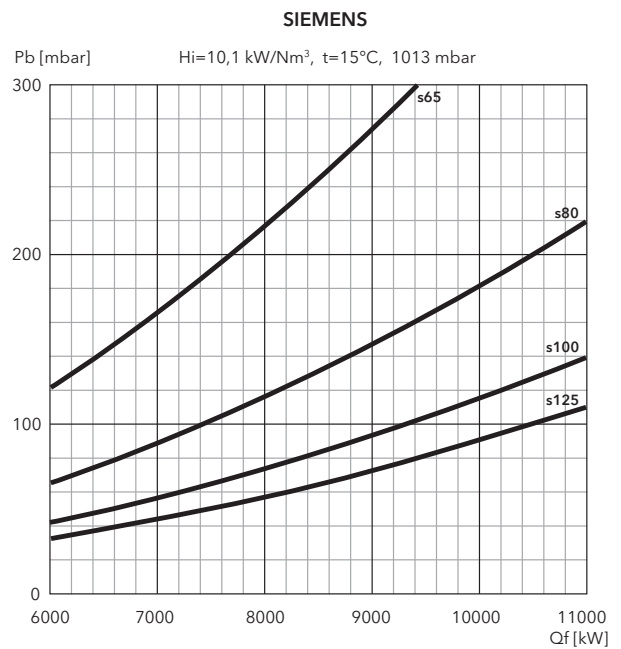
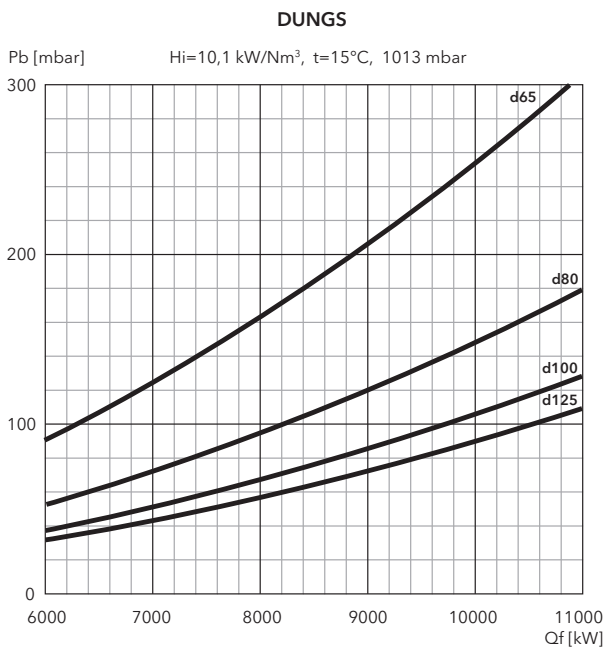

FILTERS

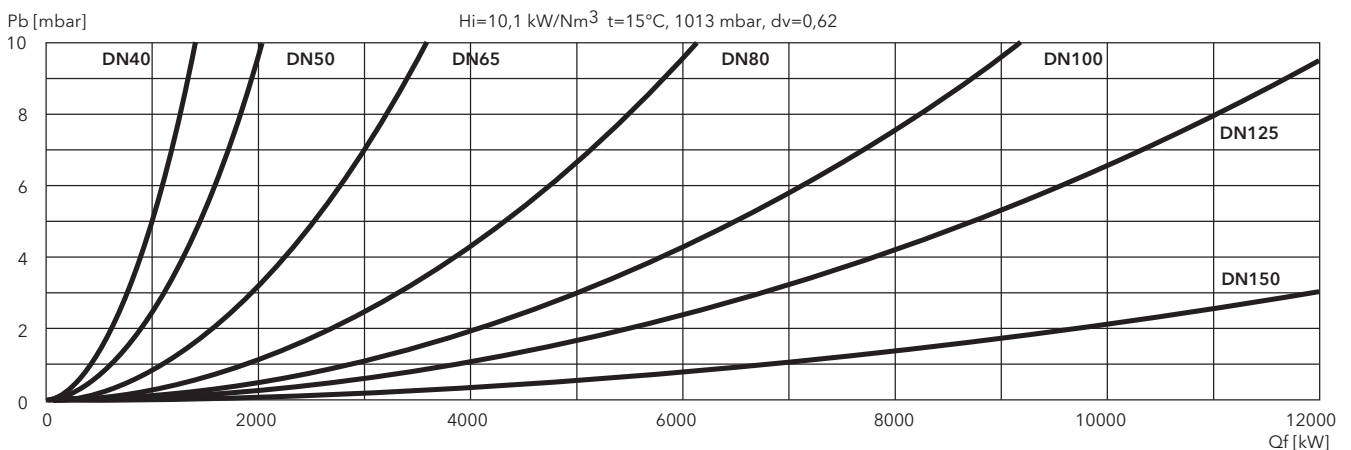

N6 L-E, N7 L-E

510 ... 4900 kW

2 stage progressive/modulating electronic

- **Fuels:** light oil, viscosity 6 mm²/s at 20°C, low calorific value 11,86 kWh/kg
- **Emission class:** Low NOx class 2 (<185 mg/kWh) according to EN267
- **Modulating ratio:** 1:3
- **Electrical power supply:** single-phase 230 V - 50 Hz
- **Protection level:** IP 41



TECHNICAL DATA

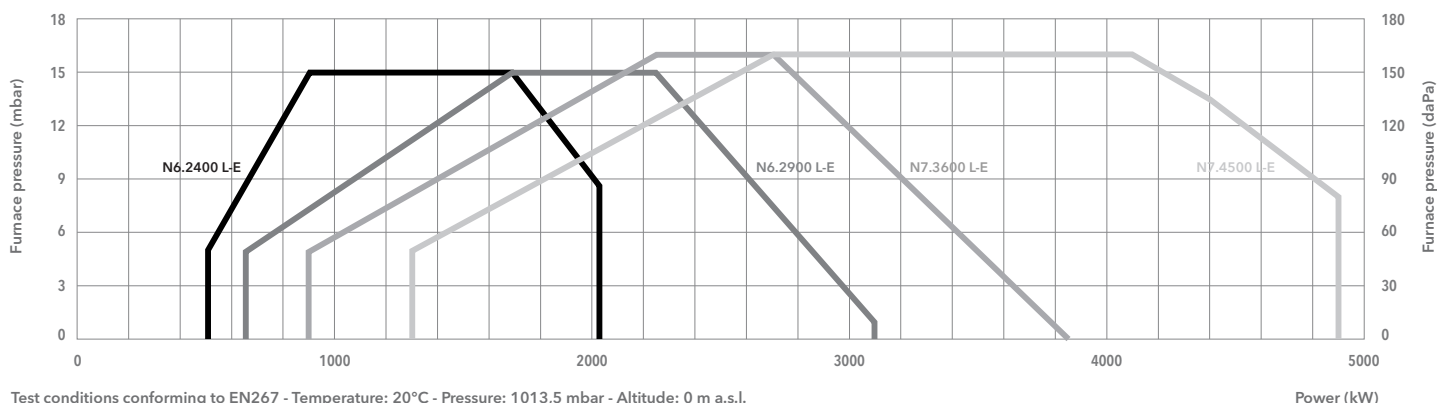

Test conditions conforming to EN267 - Temperature: 20°C - Pressure: 1013,5 mbar - Altitude: 0 m a.s.l.

	N6.2400 L-E	N6.2900 L-E	N7.3600 L-E	N7.4500 L-E
Operating range	510 - 2030 kW	650 - 3100 kW	900 - 3850 kW	1300 - 4900 kW
Fuel connection	DN20 x 1500 mm / R 1/2"	DN20 x 1500 mm / R 1/2"	DN20 x 1500 mm / R 3/4"	DN20 x 1500 mm / R 3/4"
Auxiliary voltage	1NPE AC 230 V - 50 Hz TN-S	1NPE AC 230 V - 50 Hz TN-S	1NPE AC 230 V - 50 Hz TN-S	1NPE AC 230 V - 50 Hz TN-S
Power supply	3PE AC 400 V - 50 Hz	3PE AC 400 V - 50 Hz	3PE AC 400 V - 50 Hz	3PE AC 400 V - 50 Hz
Control box / flame detector	BT300 / QRA2	BT300 / QRA2	BT300 / QRA2	BT300 / QRA2
Fan motor	50 Hz - 3 kW	50 Hz - 4 kW	50 Hz - 5,5 kW	50 Hz - 7,5 kW
Pump	SUNTEC TA3	SUNTEC TA3	SUNTEC TA4	SUNTEC TA5
Motor pump	50 Hz - 0,74 kW	50 Hz - 0,74 kW	50 Hz - 1,1 kW	50 Hz - 1,5 kW
Acoustic level	<70 dB(A)	<71 dB(A)	<74 dB(A)	<75 dB(A)
CE certificate	0085CL0215	0085CL0215	0085CL0215	0085CL0215
Burner body	3750568	3750581	3750594	3750607
	KN	3750688	3750691	3750706
Combustion head	KM	3750687	3750690	3750705
	KL	3750686	3750689	3750704
			3750706	3750709
			3750705	3750708
			3750704	3750707



DIMENSIONS (mm)

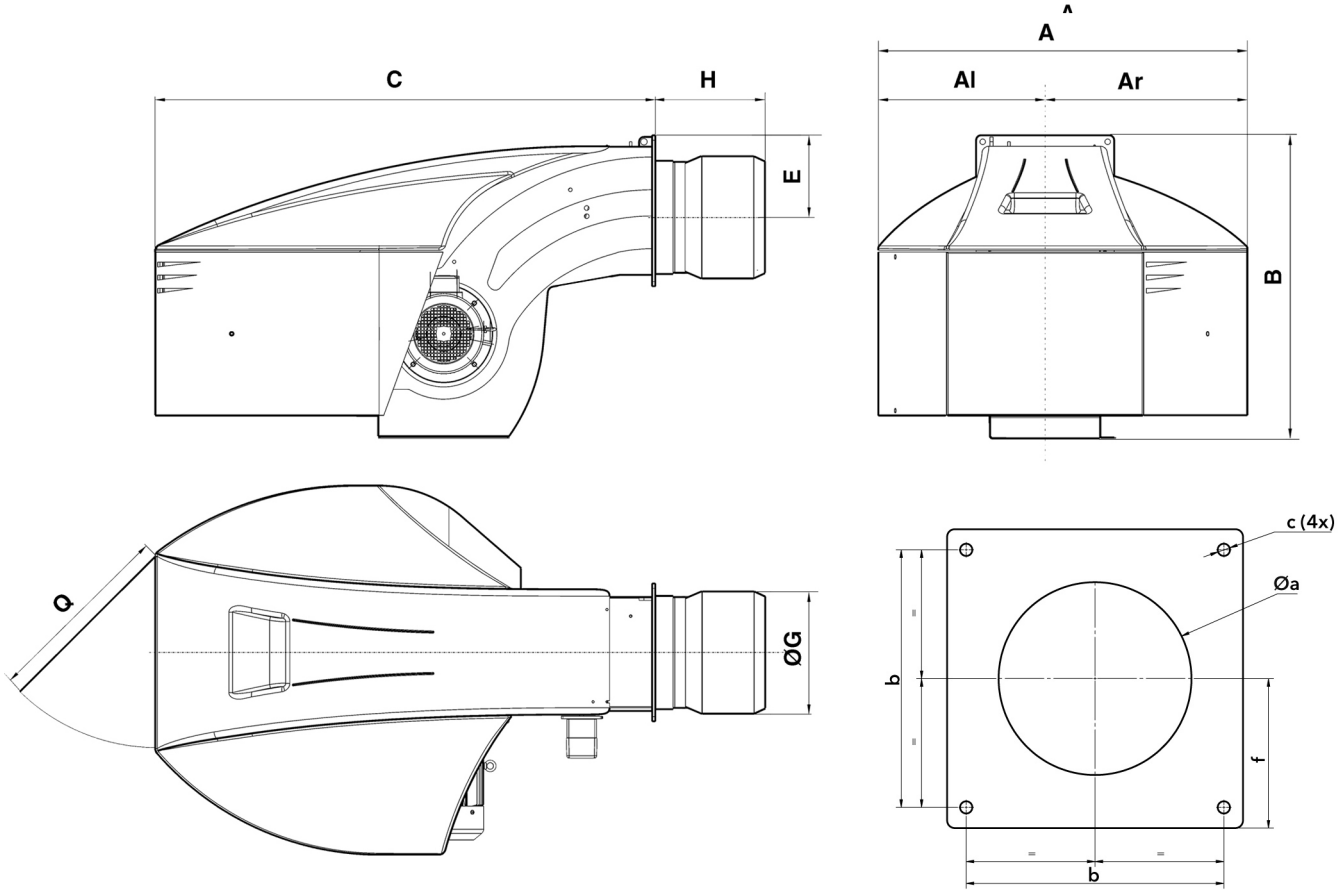

Model	A	AI	Ar	B	C	E	ØG	H			Q	Øa	b	c	f
								KN	KM	KL					
N6.2400 L-E	990	479	510	837	1361	225	290	330	450	570	600	300-340	340	M16	200
N6.2900 L-E	990	479	510	837	1361	225	310	330	450	570	600	320-340	340	M16	200
N7.3600 L-E	1128	511	618	961	1529	255	330	375	505	635	600	340-400	400	M16	235
N7.4500 L-E	1128	511	618	961	1529	255	370	375	505	635	600	380-400	400	M16	235

PACKAGING

The complete burner is delivered on a film-wrapped pallet composed of 1 package containing:

- burner body with mounted combustion head, boiler fixing accessories, technical data including electrical diagram, exploded view, spare parts list, and instruction manual.

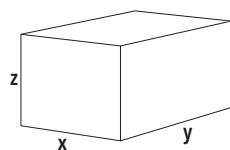

Models	Dimensions (mm)			Gross weight (kg)	
	X	Y	Z		
N6.2400 L-E	KN	1691	990	837	315
	KM	1811	990	837	315
	KL	1931	990	837	315
N6.2900 L-E	KN	1691	990	837	325
	KM	1811	990	837	325
	KL	1931	990	837	325
N7.3600 L-E	KN	1904	1128	961	360
	KM	2034	1128	961	360
	KL	2164	1128	961	360
N7.4500 L-E	KN	1904	1128	961	370
	KM	2034	1128	961	370
	KL	2164	1128	961	370

N8 L-E, N9 L-E

1350 ... 10620 kW

2 stage progressive/modulating electronic

- **Fuels:** light oil, viscosity 6 mm²/s at 20°C, low calorific value 11,86 kWh/kg
- **Emission class:** Low NOx class 2 (<185 mg/kWh) according to EN267
- **Modulating ratio:** 1:3
- **Electrical power supply:** single-phase 230 V - 50 Hz
- **Protection level:** IP 41



TECHNICAL DATA

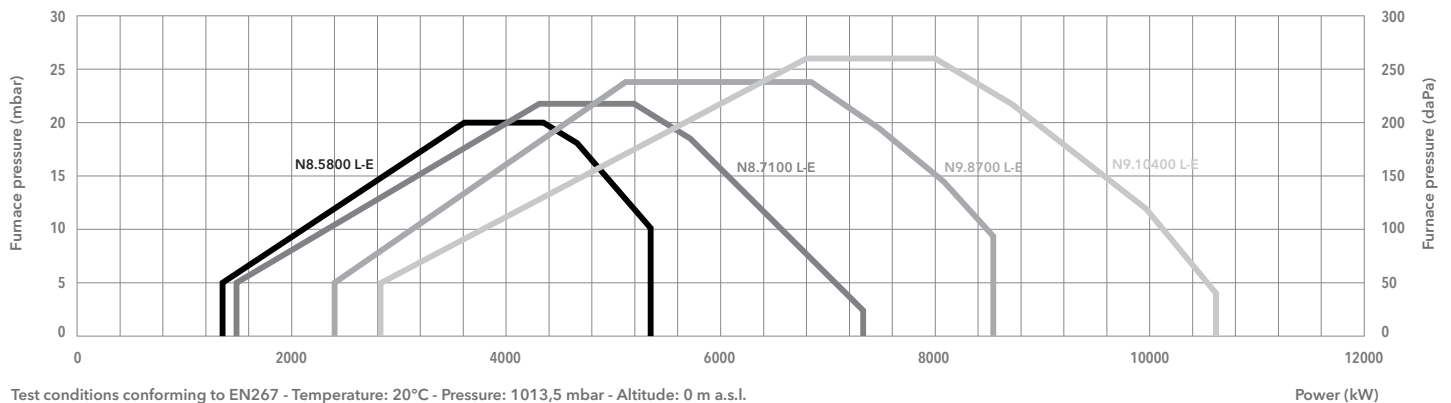

	N8.5800 L-E	N8.7100 L-E	N9.8700 L-E	N9.10400 L-E
Operating range	1350 - 5350 kW	1470 - 7340 kW	2400 - 8530 kW	2820 - 10620 kW
Fuel connection	DN20 x 1500 mm / R 3/4"	DN20 x 1500 mm / R 3/4"	DN25 x 1500 mm / R 1"	DN25 x 1500 mm / R 1"
Auxiliary voltage	1NPE AC 230 V - 50 Hz TN-S	1NPE AC 230 V - 50 Hz TN-S	1NPE AC 230 V - 50 Hz TN-S	1NPE AC 230 V - 50 Hz TN-S
Power supply	3PE AC 400 V - 50 Hz	3PE AC 400 V - 50 Hz	3PE AC 400 V - 50 Hz	3PE AC 400 V - 50 Hz
Control box / flame detector	BT300 / D-LX 100 EK-S	BT300 / D-LX 100 EK-S	BT300 / D-LX 100 EK-S	BT300 / D-LX 100 EK-S
Fan motor	50 Hz - 11 kW	50 Hz - 15 kW	50 Hz - 18,5 kW	50 Hz - 22 kW
Pump	SMG1630 - 1700 l/h	SMG1630 - 1700 l/h	SMG1631 - 2200 l/h	SMG1631 - 2200 l/h
Motor pump	50 Hz - 3 kW	50 Hz - 3 kW	50 Hz - 4 kW	50 Hz - 4 kW
Acoustic level	<77,4 dB(A)	<79,5 dB(A)	<81 dB(A)	<81,7 dB(A)
CE certificate	0085CL0215	0085CL0215	0085CL0215	0085CL0215
Burner body	3750612	3750616	3750624	3750620
	KN	3750724	3750727	3750736
Combustion head	KM	3750723	3750726	3750735
	KL	3750722	3750725	3750734
			3750733	3750738
			3750734	3750737



DIMENSIONS (mm)

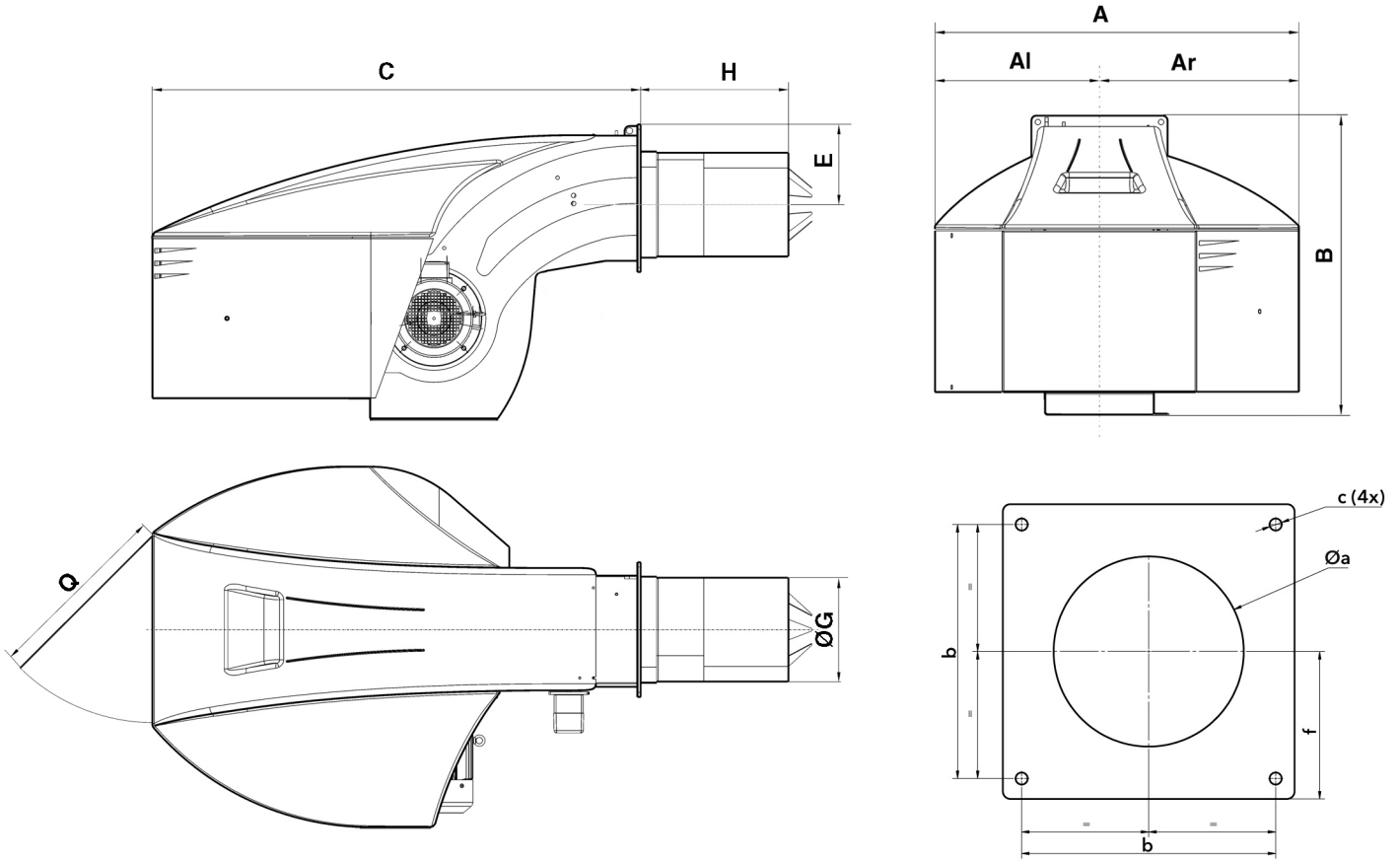

Model	A	Al	Ar	B	C	E	ØG	H			Q	Øa	b	c	f
								KN	KM	KL					
N8.5800 L-E	1414	669	745	1231	1930	293	400	562	702	842	800	430-480	505	M20	293
N8.7100 L-E	1414	669	745	1231	1930	293	415	583	723	863	800	454-480	505	M20	293
N9.8700 L-E	1414	669	745	1291	1928	293	431,5	355	505	655	800	445-480	505	M20	293
N9.10400 L-E	1414	669	745	1291	1928	293	431,5	355	505	655	800	445-480	505	M20	293

PACKAGING

The complete burner is delivered on a film-wrapped pallet composed of 1 package containing:

- burner body with mounted combustion head, boiler fixing accessories, technical data including electrical diagram, exploded view, spare parts list, and instruction manual.

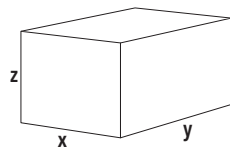

Models	Dimensions (mm)			Gross weight (kg)	
	X	Y	Z		
N8.5800 L-E	KN	2492	1414	1231	630
	KM	2632	1414	1231	637
	KL	2772	1414	1231	643
N8.7100 L-E	KN	2513	1414	1231	630
	KM	2653	1414	1231	639
	KL	2793	1414	1231	645
N9.8700 L-E	KN	2283	1414	1291	652
	KM	2433	1414	1291	660
	KL	2583	1414	1291	667
N9.10400 L-E	KN	2283	1414	1291	662
	KM	2433	1414	1291	670
	KL	2583	1414	1291	677

N6 L-EF3, N7 L-EF3

360 ... 4820 kW
2 stage progressive/modulating electronic (Low NOx class 3)

- **Fuels:** light oil, viscosity 6 mm²/s at 20°C, low calorific value 11,86 kWh/kg
- **Emission class:** Low NOx class 3 (<120 mg/kWh) according to EN267
- **Modulating ratio:** 1:3
- **Electrical power supply:** single-phase 230 V - 50 Hz
- **Protection level:** IP 41



TECHNICAL DATA

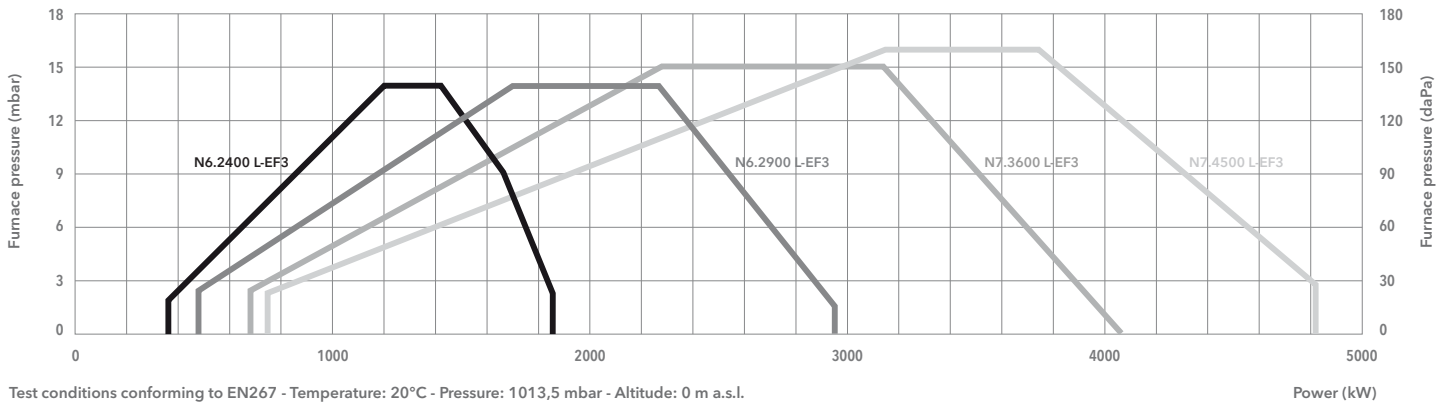

Test conditions conforming to EN267 - Temperature: 20°C - Pressure: 1013,5 mbar - Altitude: 0 m a.s.l.

	N6.2400 L-EF3	N6.2900 L-EF3	N7.3600 L-EF3	N7.4500 L-EF3
Operating range	360 - 1850 kW	480 - 2950 kW	680 - 4070 kW	740 - 4820 kW
Fuel connection	DN20 x 1500 mm / R 1/2"	DN20 x 1500 mm / R 1/2"	DN20 x 1500 mm / R 3/4"	DN20 x 1500 mm / R 3/4"
Auxiliary voltage	1NPE AC 230 V - 50 Hz TN-S	1NPE AC 230 V - 50 Hz TN-S	1NPE AC 230 V - 50 Hz TN-S	1NPE AC 230 V - 50 Hz TN-S
Power supply	3PE AC 400 V - 50 Hz	3PE AC 400 V - 50 Hz	3PE AC 400 V - 50 Hz	3PE AC 400 V - 50 Hz
Control box / flame detector	BT300 / D-LX 100 EK-S	BT300 / D-LX 100 EK-S	BT300 / D-LX 100 EK-S	BT300 / D-LX 100 EK-S
Fan motor	50 Hz - 3 kW	50 Hz - 4 kW	50 Hz - 7,5 kW	50 Hz - 7,5 kW
Pump	SUNTEC TA3	SUNTEC TA3	SUNTEC TA4	SUNTEC TA5
Motor pump	50 Hz - 0,74 kW	50 Hz - 0,74 kW	50 Hz - 1,1 kW	50 Hz - 1,5 kW
Acoustic level	<71 dB(A)	<71 dB(A)	<76 dB(A)	<74 dB(A)
CE certificate	0085CL0215	0085CL0215	0085CL0215	0085CL0215
Burner body	3750569	3750582	3750595	3750608
	KN 3750694	3750697	3750712	3750715
Combustion head	KM 3750693	3750696	3750711	3750714
	KL 3750692	3750695	3750710	3750713



DIMENSIONS (mm)

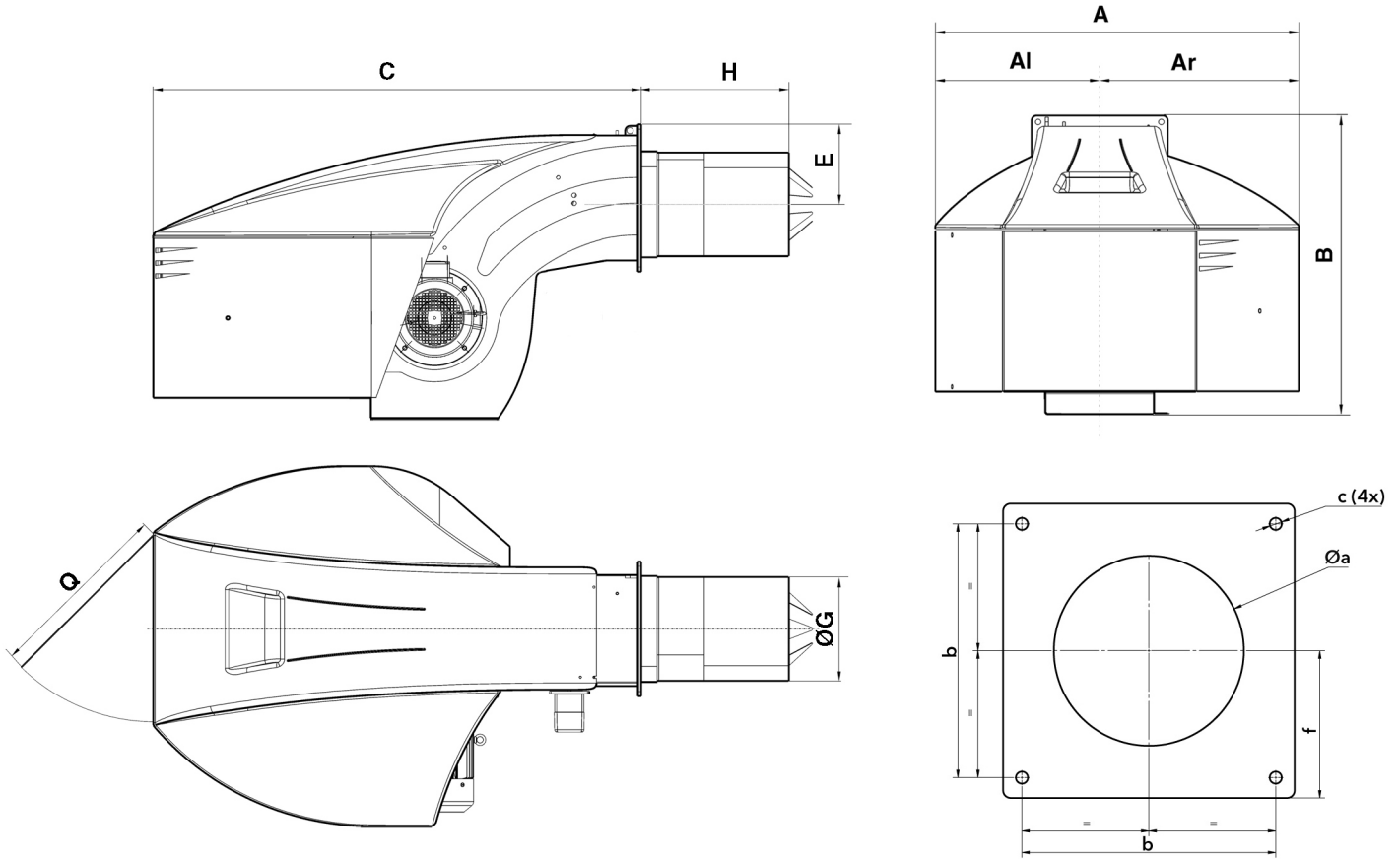

Model	A	Al	Ar	B	C	E	ØG	H			Q	Øa	b	c	f
								KN	KM	KL					
N6	990	479	510	837	1361	225	264	330	450	570	600	300-340	340	M16	200
N7	1128	511	618	961	1529	255	325	375	505	635	600	360-400	400	M16	235

PACKAGING

The complete burner is delivered on a film-wrapped pallet composed of 1 package containing:

- burner body with mounted combustion head, boiler fixing accessories, technical data including electrical diagram, exploded view, spare parts list, and instruction manual.

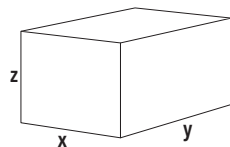

Models		Dimensions (mm)			Gross weight (kg)
		X	Y	Z	
N6.2400 L-EF3	KN	1861	990	837	315
	KM	1981	990	837	315
	KL	2101	990	837	315
N6.2900 L-EF3	KN	1861	990	837	325
	KM	1981	990	837	325
	KL	2101	990	837	325
N7.3600 L-EF3	KN	2029	1128	961	360
	KM	2179	1128	961	360
	KL	2309	1128	961	360
N7.4500 L-EF3	KN	2029	1128	961	370
	KM	2179	1128	961	370
	KL	2309	1128	961	370

N8 L-EF3, N9 L-EF3, N9 L-EUF

1100 ... 9570 kW

2 stage progressive/modulating electronic (Low NOx class 3)

- **Fuels:** light oil, viscosity 6 mm²/s at 20°C, low calorific value 11,86 kWh/kg
- **Emission class:** Low NOx class 3 (<120 mg/kWh) according to EN267
- **Modulating ratio:** 1:3
- **Electrical power supply:** single-phase 230 V - 50 Hz
- **Protection level:** IP 41



TECHNICAL DATA

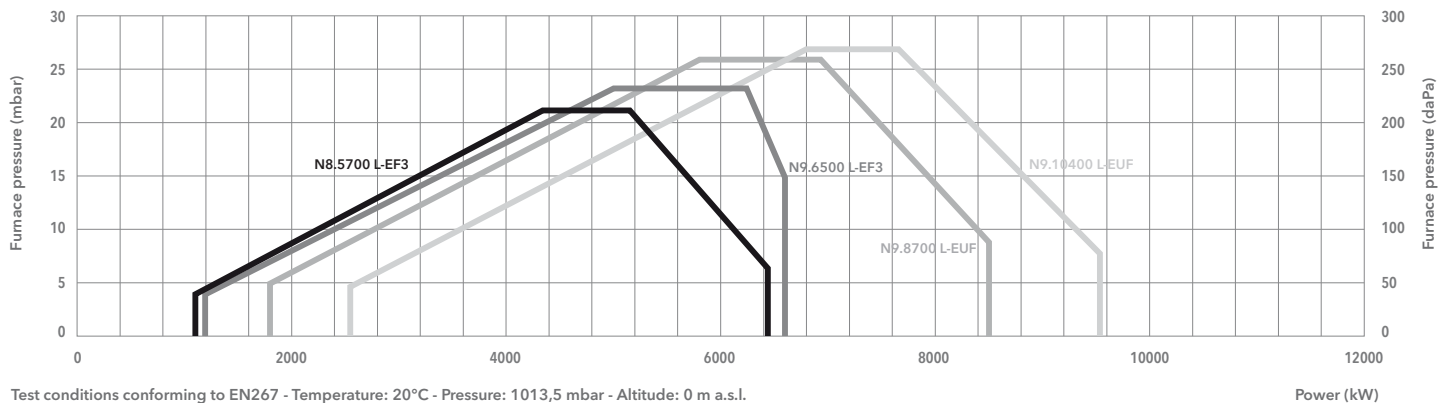

Test conditions conforming to EN267 - Temperature: 20°C - Pressure: 1013,5 mbar - Altitude: 0 m a.s.l.

	N8.5700 L-EF3	N9.6500 L-EF3	N9.8700 L-EUF	N9.10400 L-EUF
Operating range	1100 - 6450 kW	1200 - 6600 kW	1800 - 8500 kW	2550 - 9570 kW
Fuel connection	DN20 x 1500 mm / R 3/4"	DN20 x 1500 mm / R 3/4"	DN20 x 1500 mm / R 3/4"	DN25 x 1500 mm / R 1"
Auxiliary voltage	1NPE AC 230 V - 50 Hz TN-S	1NPE AC 230 V - 50 Hz TN-S	1NPE AC 230 V - 50 Hz TN-S	1NPE AC 230 V - 50 Hz TN-S
Power supply	3PE AC 400 V - 50 Hz	3PE AC 400 V - 50 Hz	3PE AC 400 V - 50 Hz	3PE AC 400 V - 50 Hz
Control box / flame detector	BT300 / D-LX 100 EK-S	BT300 / D-LX 100 EK-S	BT300 / D-LX 100 EK-S	BT300 / D-LX 100 EK-S
Fan motor	50 Hz - 15 kW	50 Hz - 22 kW	50 Hz - 18,5 kW	50 Hz - 22 kW
Pump	SMG1630 - 1700 l/h	SMG1630 - 1700 l/h	SMG1630 - 1700 l/h	SMG1631 - 2200 l/h
Motor pump	50 Hz - 3 kW	50 Hz - 3 kW	50 Hz - 3 kW	50 Hz - 4 kW
Acoustic level	<80,2 dB(A)	<82,9 dB(A)	<81 dB(A)	<81,7 dB(A)
CE certificate	0085CL0215	0085CL0215	0085CL0215	0085CL0215
Burner body	3751407	3751408	3751494	3751495
	KN 3751482	3751485	3751488	3751491
Combustion head	KM 3751483	3751486	3751489	3751492
	KL 3751484	3751487	3751490	3751493



DIMENSIONS (mm)

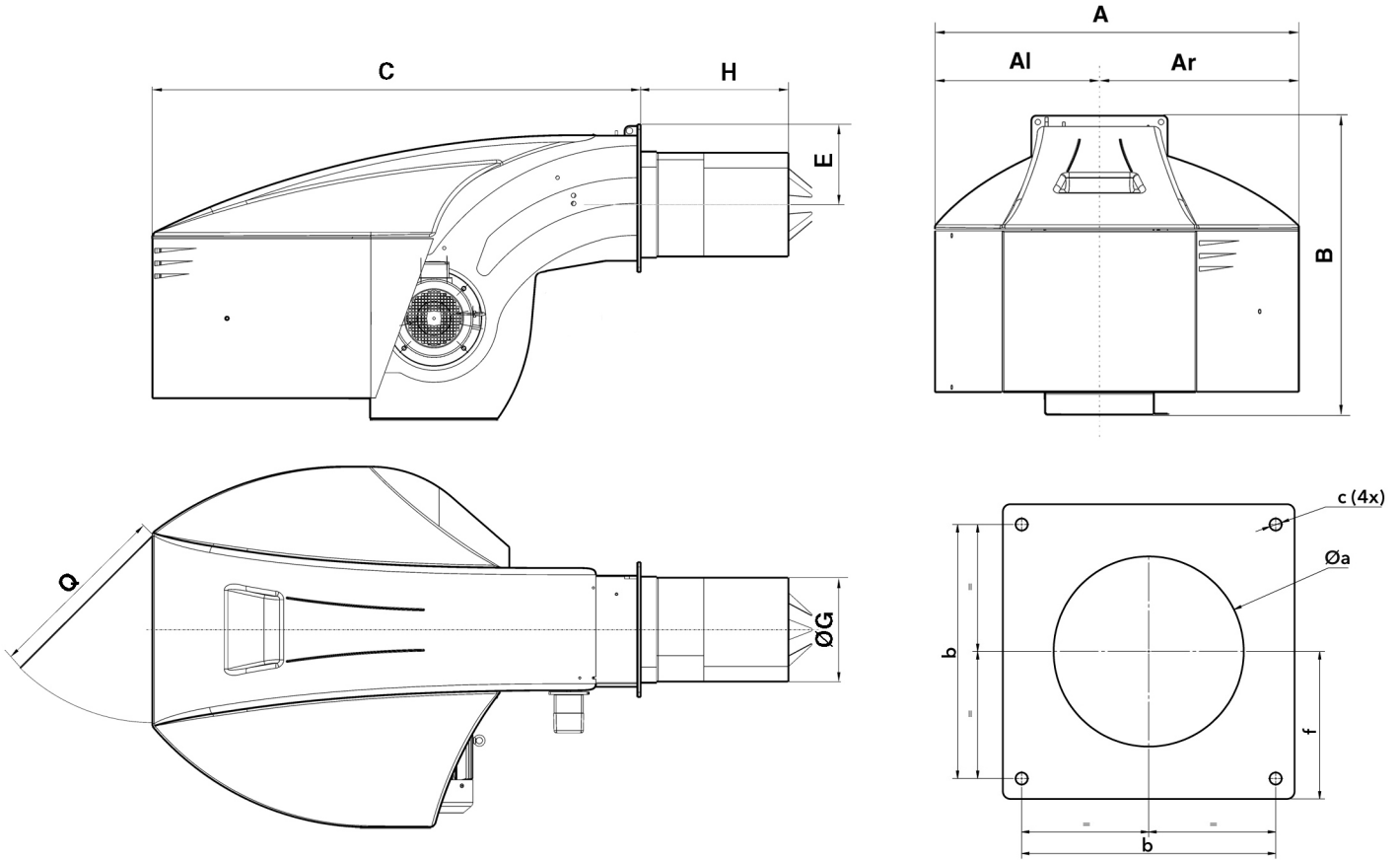

Model	A	Al	Ar	B	C	E	ØG	H			Q	Øa	b	c	f
								KN	KM	KL					
N8.5700	1414	669	745	1291	1928	293	369	528	668	808	800	380-410	505	M20	293
N9.6500	1414	669	745	1291	1928	293	431,5	543	693	843	800	445-480	505	M20	293
N9 L-EUF	1414	669	745	1291	1928	293	431,5	575	725	875	800	445-480	505	M20	293

PACKAGING

The complete burner is delivered on a film-wrapped pallet composed of 1 package containing:

- burner body with mounted combustion head, boiler fixing accessories, technical data including electrical diagram, exploded view, spare parts list, and instruction manual.

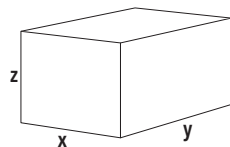

Models	Dimensions (mm)			Gross weight (kg)	
	X	Y	Z		
N8.5700 L-EF3	KN	2530	1414	1231	600
	KM	2670	1414	1231	608
	KL	2810	1414	1231	615
N9.6500 L-EF3	KN	2550	1414	1291	670
	KM	2700	1414	1291	678
	KL	2850	1414	1291	685
N9.8700 L-EUF	KN	2503	1414	1291	652
	KM	2653	1414	1291	660
	KL	2803	1414	1291	667
N9.10400 L-EUF	KN	2503	1414	1291	662
	KM	2653	1414	1291	670
	KL	2803	1414	1291	677

BURNER VARIANTS (options already mounted in factory)

LCM MODULE (for communication, O₂ control, frequency converter)

Module mounted in factory, requested for O ₂ control, Variatron and communication buses connections (the module is available also on request as a separate kit) Note: only one LCM module is necessary for these 3 options	3751118
------------------------------------------------------------------------------------------------------------------------------------------------------------------------------------------------------------------------------------------	---------

MODULATING OPERATION

Regulator RWF55 + instruction manual mounted in factory on the switch cabinet to be connected to the appropriate probe (see "BURNER KITS" session)	for N6/N7 G-R/VVF3	3752363
	for N6...N9 in electronic configuration	3752364
	for N6/N7 GL-RZ3	3752365

FREQUENCY CONVERTER

Variatron mounted in factory inside the switch cabinet including the VSM module for the burners with BT300 control box
Note: one LCM module is required and must be ordered separately (for burners equipped with the BT300)

Frequency converter for N6.2400 G-V and G-VF3	3750782
Frequency converter for N6.2900 G-V and G-VF3	3750783
Frequency converter for N7.3600 G-V	3750784
Frequency converter for N7.4500 G-V, N7.3600 G-VF3 and N7.4500 G-VF3	3750785
Frequency converter for N6.2400 G-E/G-EF3, GL... and L-E	3751418
Frequency converter for N6.2900 G-E/G-EF3, GL... and L-E	3751419
Frequency converter for N7.3600 G-E/G-EF3, GL... and L-E	3751420
Frequency converter for N7.4500 G-E/G-EF3, GL... and L-E	3751421
Frequency converter for N8.5800 G-E/G-EU3	3750778
Frequency converter for N8.7100 G-E/G-EU3	3750779
Frequency converter for N9.8700 G-E/G-EU3	3750780
Frequency converter for N9.10400 G-E/G-EU3	3750781
Frequency converter for N8.5800 GL... and L-E	3751422
Frequency converter for N8.7100 GL... and L-E	3751423
Frequency converter for N9.8700 GL... and L-E	3751424
Frequency converter for N9.10400 GL... and L-E	3751425
Frequency converter for N9.8700 GL-EUF	3751498
Frequency converter for N9.10400 GL-EUF	3751499

FREQUENCY CONVERTER ARRANGEMENT

Burner prepared to be connected to an external frequency inverter
Note: one LCM module is required and must be ordered separately (for burners equipped with the BT300)

N6 G-V prepared for an external frequency converter	3751453
N7.3600 G-V/G-VF3 prepared for an external frequency converter of 5,5 kW	3751456
N7.4500 G-V/G-VF3 prepared for an external frequency converter of 7,5 kW	3751457
N6.2400 G-E/G-EF3 prepared for an external frequency converter of 3 kW	3751426
N6.2900 G-E/G-EF3 prepared for an external frequency converter of 4 kW	3751427
N7.3600 G-E prepared for an external frequency converter of 5,5 kW	3751428
N7.3600 G-EF3 and N7.4500 G-E/G-EF3 prepared for an external frequency converter of 7,5 kW	3751429
N8.5800 G-E prepared for an external frequency converter of 11 kW	3751113
N8.7100 G-E prepared for an external frequency converter of 15 kW	3751114
N9.8700 G-E prepared for an external frequency converter of 18,5 kW	3751115
N9.10400 G-E prepared for an external frequency converter of 22 kW	3751116
N6 GL... and N6 L... prepared for an external frequency converter of 3 kW	3751430
N6 GL... and N6 L... prepared for an external frequency converter of 4 kW	3751431
N7 GL... and N7 L... prepared for an external frequency converter of 5,5 kW	3751432
N7 GL... and N7 L... prepared for an external frequency converter of 7,5 kW	3751433
N8 GL... and N8 L... prepared for an external frequency converter of 11 kW	3751434
N8 GL... and N8 L... prepared for an external frequency converter of 15 kW	3751435
N9 GL-E and N9 L... prepared for an external frequency converter of 18,5 kW	3751436
N9 GL-E/GL-EF3 and N9 L... prepared for an external frequency converter of 22 kW	3751437
N9.8700 GL-EUF prepared for an external frequency converter of 18,5 kW	3751500
N9.10400 GL-EUF prepared for an external frequency converter of 22 kW	3751501

PED EQUIPMENT

Equipment of the gas train and the burner body for continuous operation (PED): controller and flame sensor approved for continuous operation, maximum gas pressure switch on the gas train, test burner (to bleed the gas train), PED Conformity Declaration.

Note: if required, the antivibrating coupling (to avoid mechanical tension) has to be selected as option

PED for N6/N7 G-R	with Siemens threaded gas trains	3750315
	with Siemens flanged gas trains	3750413
	with Dungs threaded gas trains	3750746
	with Dungs flanged gas trains	3750747
PED for N6/N7 G-V	with Siemens threaded gas trains	3750752
	with Siemens flanged gas trains	3750753
PED for N6/N7 G-VF3	with Siemens threaded gas trains	3750756
	with Siemens flanged gas trains	3750757
PED for N6/N7 G-E	with Siemens threaded gas trains	3750768
	with Siemens flanged gas trains	3750769
	with Dungs threaded gas trains	3750770
	with Dungs flanged gas trains	3750771
PED for N8/N9 G-E	with Siemens threaded gas trains	3751120
	with Siemens flanged gas trains	3751121
	with Dungs threaded gas trains	3751122
	with Dungs flanged gas trains	3751123
PED for N6/N7 G-EF3	with Siemens threaded gas trains	3750772
	with Siemens flanged gas trains	3750773
	with Dungs threaded gas trains	3750.873
	with Dungs flanged gas trains	3751058
PED for N6/N7 GL-RZ3	with Siemens threaded gas trains	3750760
	with Siemens flanged gas trains	3750761
	with Dungs threaded gas trains	3750762
	with Dungs flanged gas trains	3750763
PED for N6/N7 GL-E	with Siemens threaded gas trains	3751059
	with Siemens flanged gas trains	3751060
	with Dungs threaded gas trains	3751061
	with Dungs flanged gas trains	3750447
PED for N6/N7 GL-EF3	with Siemens threaded gas trains	3751062
	with Siemens flanged gas trains	3751063
	with Dungs threaded gas trains	3750450
	with Dungs flanged gas trains	3751064
PED for N8/N9 GL-E	with Siemens threaded gas trains	3751069
	with Siemens flanged gas trains	3751070
	with Dungs threaded gas trains	3751071
	with Dungs flanged gas trains	3751072
PED for N8/N9 GL-EF3	with Siemens threaded gas trains	3750460
	with Siemens flanged gas trains	3751073
	with Dungs threaded gas trains	3751074
	with Dungs flanged gas trains	3751075
PED for N6...N9 G-... and GL-... with terminal block switch cabinet	with Siemens threaded gas trains	3750764
	with Siemens flanged gas trains	3750765
	with Dungs threaded gas trains	3750766
	with Dungs flanged gas trains	3750767
PED for N6/N7 L-E		3751065
PED for N6/N7 L-EF3		3751066
PED for N8/N9 L-E		3751067
PED for N8/N9 L-EF3		3751068

MAX GAS PRESSURE SWITCH (mounted on the gas train)

N6/N7 G-R/V/VF3 and GL-RZ3 with Siemens threaded gas trains	with Siemens threaded gas trains	3751080
	with Siemens flanged gas trains	3751081
	with Dungs threaded gas trains	3751082
	with Dungs flanged gas trains	3751083
N6/N7 G/GL	with Siemens threaded gas trains	3751088
	with Siemens flanged gas trains	3751089
	with Dungs threaded gas trains	3751090
	with Dungs flanged gas trains	3751091
N8/N9 G-E/EU3 and N8/N9 GL-E/EF3	with Siemens threaded gas trains	3751124
	with Siemens flanged gas trains	3751125
	with Dungs threaded gas trains	3751126
	with Dungs flanged gas trains	3751127
N6...N9 G-E with terminal block switch cabinet	with Siemens threaded gas trains	3751076
	with Siemens flanged gas trains	3751077
	with Dungs threaded gas trains	3751078
	with Dungs flanged gas trains	3751079

STAR/DELTA MOTOR STARTER

Star/Delta 3,0 G/BT3 for N6.2400	3751414
Star/Delta 4,0 G/BT3 for N6.2900	3751415
Star/Delta 5,5 G/BT3 for N7.3600	3751416
Star/Delta 7,5 G/BT3 for N7.4500	3751417

BLIND DOOR

Door of the switch cabinet without any component. The switches and the power regulator (if required) are mounted inside the switch cabinet

For N6/N7 in gas and light oil	3751411
For N6/N7 in dual fuel	3751412
For N8/N9 in gas and light oil	3751119
For N8/N9 in dual fuel	3751413

REMOTE SIGNAL 4-20 mA

Remote signal 4-20 mA for BT300 burner variant (Note: one LCM module is required for the burners equipped with the BT300)	14099397
------------------------------------------------------------------------------------------------------------------------------	----------

BURNER KITS (delivered separately)
O₂/CO REGULATION

Kit for O ₂ and CO control Note: one LCM module is required	Kit O ₂ LT2/LS2 / 300 mm	3751129
	Kit O ₂ /CO LT2/KS1 / 300 mm	3751128

REMOTE SOFTWARE

Kit to connect a PC laptop to the BT300 for its parametrization	LSA100 + USB/CAN + CD-Rom	3751130
-----------------------------------------------------------------	---------------------------	---------

COMMUNICATION MODULES

Module for external installation Note: one LCM module is required	ModBus/BT3	on request
	ProfiBus/BT3	3752986
	Ethernet/BT3	in progress

POWER REGULATOR

Power regulator RWF55 stand-alone and kit wiring	on request
--------------------------------------------------	------------

PROBES

Immersion probes	130°C + pocket tube	3750070
	Pt 100 - 400°C (160 mm)	1758574269
	Pt 100 - 480°C (250 mm)	3751009
Pressure probes	0...1,6 bar	3752217
	0...2,5 bar	1758713722
	0...6 bar	1758640660
	0...10 bar	1758577280
	0...16 bar	1758577291
	0...25 bar	3751015

COUNTER FACE PLATE

CP11	for N6	3833908
CP12	for N7	3833909
CP13	for N8	3833910
CP14	for N9	3833911

SEALS AND CONNECTING KIT

DN40	3751040
DN50	3751041
DN65	3751042
DN80	3751043
DN100	3751044
DN125	3751045
DN150	3751046

SPECIAL CONFIGURATION (on request)

Equipment according EN746-2, permanent ventilation, 60 Hz versions, remote display (BT3xx), separate switch box / terminal strip version (Etamatic OEM), LGP firing, hinge flange, "Burner ON" feedback signal.
Other special requests can be submitted to Your Sales Reference for feasibility evaluation.

Monoblock burners from 1300 to 16000 kW

Gas, light oil and dual fuel

High power and ease of use up to 16 MW

Wherever a compact solution is needed, a monoblock burner offers advantages over individual components. However, above a power output of 10 MW, the conventional burner becomes too heavy: ease of handling during installation and maintenance work suffers, the strain on the boiler door is too high. N10 burner solves this problem with innovative, weight-saving enclosure technology. The key feature is the physical division of the burner into a support frame and a separate air-routing housing. Thanks to its innovative solutions N10 provides high performance and ease of use up to 16 MW.



Load distribution and reduced weight

N10 is characterised by a chassis frame mounted directly on the door of the generator; this independently supports the fan and motor assembly, which constitutes a large proportion of the total weight of the burner. This structure significantly reduces the torque generated by the motor and, consequently, reduces the strain on the boiler door.

The choice of materials has been dictated by the need to reduce weight: as a result, the combustion air inlet is made of composite materials, and the air register flaps in aluminium.

Simplified structure to improve usability

The burner head and the housing have been almost entirely separated in order to allow sufficient space for the combustion components to be easily removed. The air pipe between the housing and the burner head is simply closed by a removable cover. It is no longer necessary to pivot the entire body of the burner to one side or the other.

An added advantage is the ability to fix the frame to the ground, depending on the application, thus relieving the generator door from any mechanical stress.

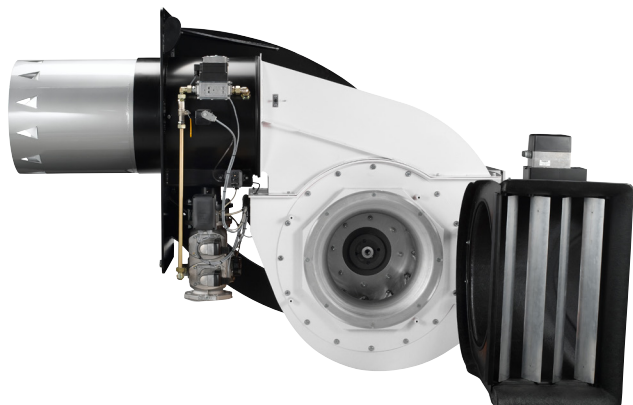

Advanced design for low noise levels

Special attention has been paid to fan design. The burner's acoustic level meets industry standards, providing a more comfortable working environment. The two main characteristics which limit the noise emitted by a fan are a high and constant static pressure and the use of a wheel with rearward facing blades. The result is a stable combustion and reduced noise at the air inlet.

MAIN TECHNICAL FEATURES

- Two stage progressive/modulating forced draught burner
- Fuels:
 - natural gas, low calorific value 6,99...11,39 kWh/Nm³
 - light oil, viscosity 6 mm²/s at 20°C, low calorific value 11,86 kWh/kg
- Combustion technology:
 - Low NOx class 2 (<120 mg/kWh) and class 3 (<80 mg/kWh) in gas operation according to EN676
 - Low NOx class 2 (<185 mg/kWh) and class 3 (<120 mg/kWh) in light oil operation according to EN267
- Control box: built-in or external according to customer requirements
- Three flame tube lengths available
- Secured burner head adjustments during maintenance (RTC System)
- Closing of the air damper on burner shut-down
- Multiple gas train matching according to the inlet gas pressure
- Gas train factory assembled and tested for tightness and electrical security
- Products are in compliance with EN676 and EN267 European standards and with the following directives:
 - 2014/35/UE Low Voltage Directive
 - 2014/30/UE EMC Directive
 - 2009/142/CEE Gas Appliances Directive
 - 2006/42/EC Machinery Directive
 - 2011/65/EU RoHS2 Directive

RANGE OVERVIEW

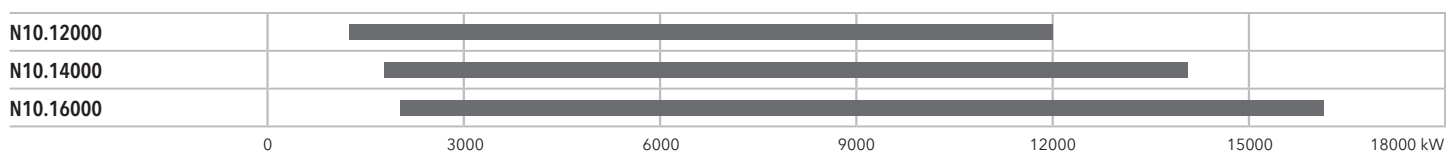

N10 G-E

1300 ... 16000 kW

2 stage progressive/modulating electronic

- **Fuels:** natural gas, low calorific value 8,83 ... 10,53 kWh/m³
- **Emission class:** Low NOx class 2 (<120 mg/kWh) according to EN676
- **Electrical power supply:** three-phase 230 V - 50 HZ
- **Protection level:** IP 40 (IP 54 as option).



TECHNICAL DATA

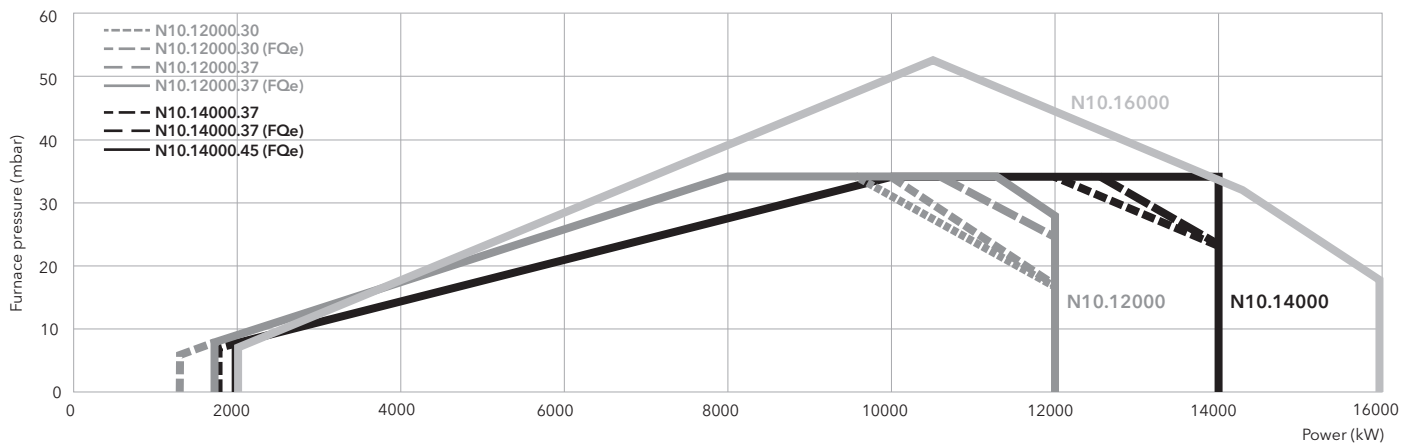

	N10.12000.30 G-E	N10.12000.37 G-E	N10.14000.37 G-E	N10.14000.45 G-E	N10.16000.45 G-E
Operating range	1300* - 12000 kW (*: 1750 without FQ)	1300* - 12000 kW (*: 1750 without FQ)	1750* - 14000 kW (*: 2000 without FQ)	1750 - 14000 kW	2000 - 16000 kW
Fan motor	2950 rpm - 400/690 V 50/60 Hz - 30 kW	2950 rpm - 400/690 V 50/60 Hz - 37 kW	2950 rpm - 400/690 V 50/60 Hz - 37 kW	2950 rpm - 400/690 V 50/60 Hz - 45 kW	2950 rpm - 400/690 V 50/60 Hz - 45 kW
Acoustic level	< 97 dB(A)	< 97 dB(A)	< 97 dB(A)	< 97 dB(A)	< 97 dB(A)
CE certificate	if requested: to be carried out on site, not included in our offer				
Complete burner code	on request				

GAS TRAINS

DUNGS

Model	Code
d80	on request
d100	on request
d125	on request

SIEMENS

Model	Code
s80	on request
s100	on request
s125	on request
s150	on request

FILTERS

Model	Code
FG-DN80	3750546
FG-DN100	3750547
FG-DN125	3750548
FG-DN150	on request

 **Pressure drops graphs:** see following pages
Dimensions of gas trains and gas filters: see pag.202

DIMENSIONS (mm)

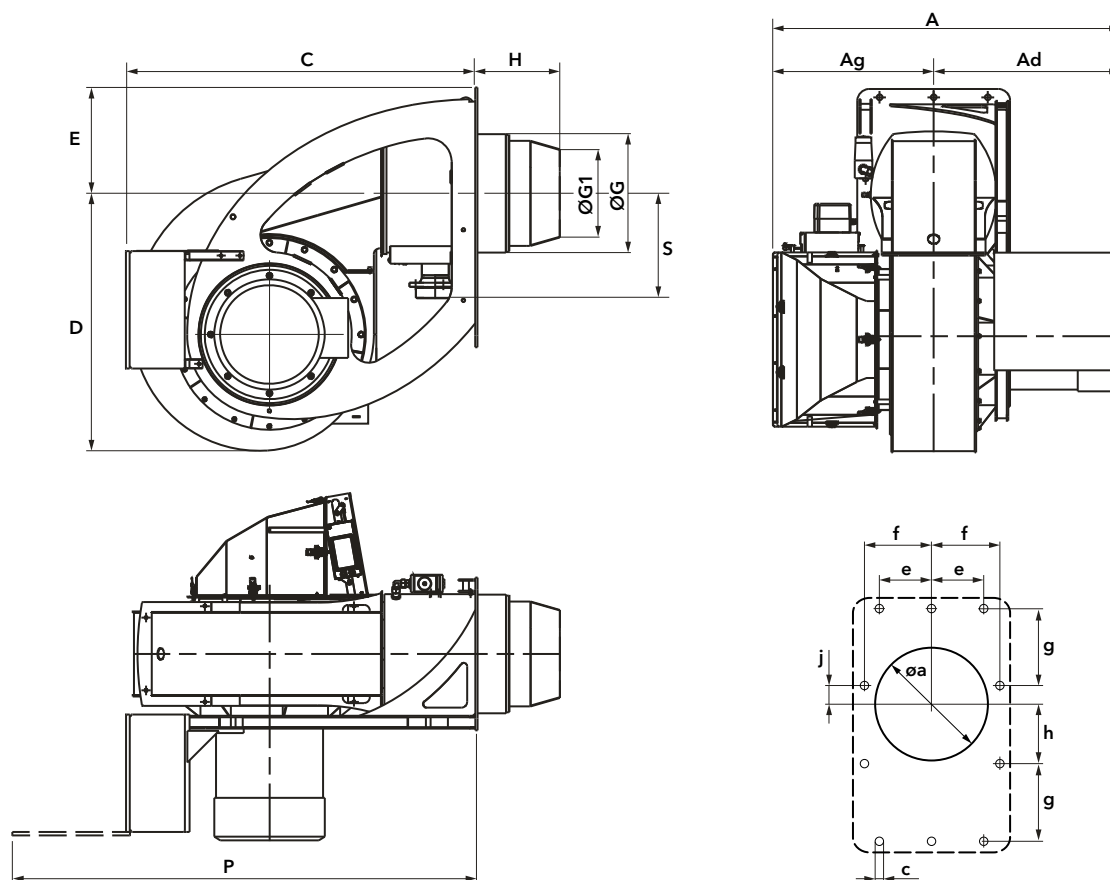

Model	A	Ad	Ag	C	D	E	ØG	ØG1	H			P	S	Øa	c	e	f	g	h	j
									kN	KM	KL									
N10 G-E	1480	795	685	1500	1095	450	369	504	350	450	550	1980	446	525	M20	230	290	345	275	70

PACKAGING

The complete burner is delivered on a pallet with:

- 1 carton box for gas train and filter
- 1 carton box for boiler fixing accessories
- 1 bag with technical documentation

Models	Dimensions (mm)			Gross weight (kg)
	X	Y	Z	
N10 G-E	1505	2125	1545	550 (+100 for transport rack)

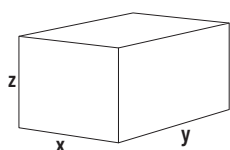

PRESSURE LOSSES (BURNER HEAD + GAS TRAIN)

N10.12000 G-E

DUNGS

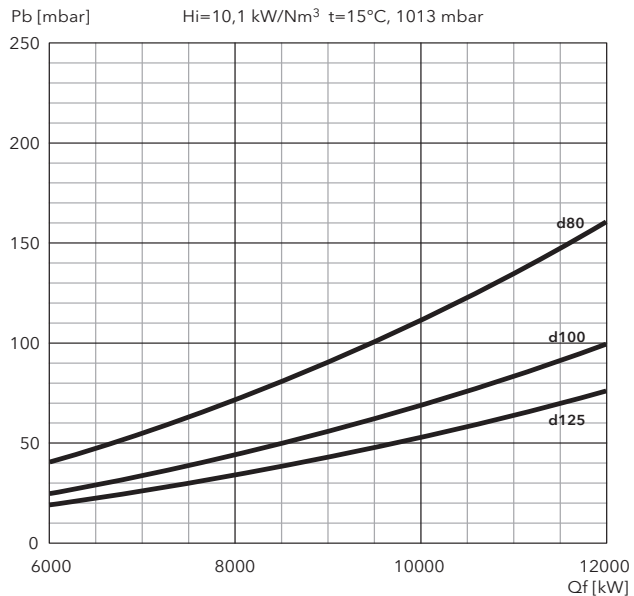

SIEMENS

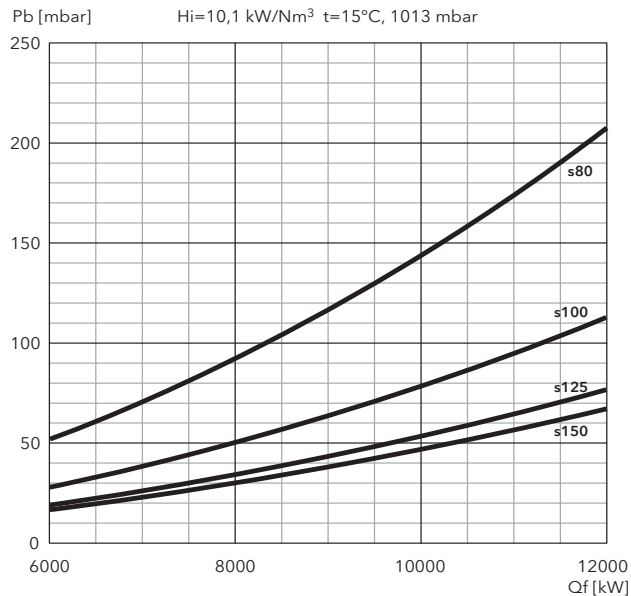

N10.14000 G-E

DUNGS

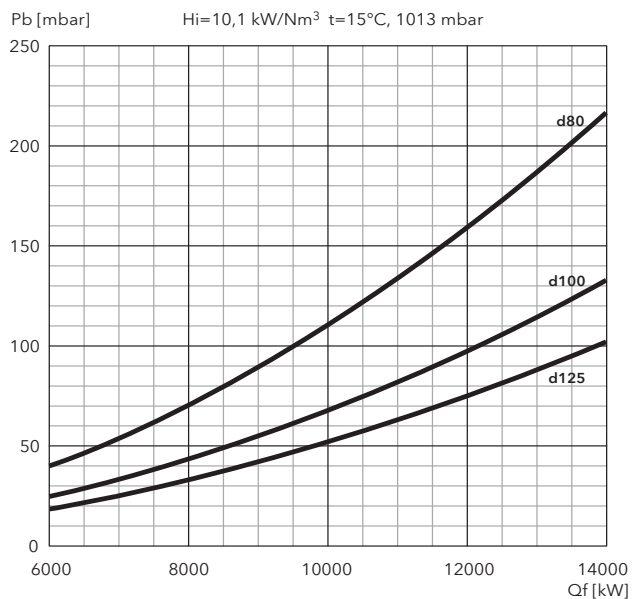

SIEMENS

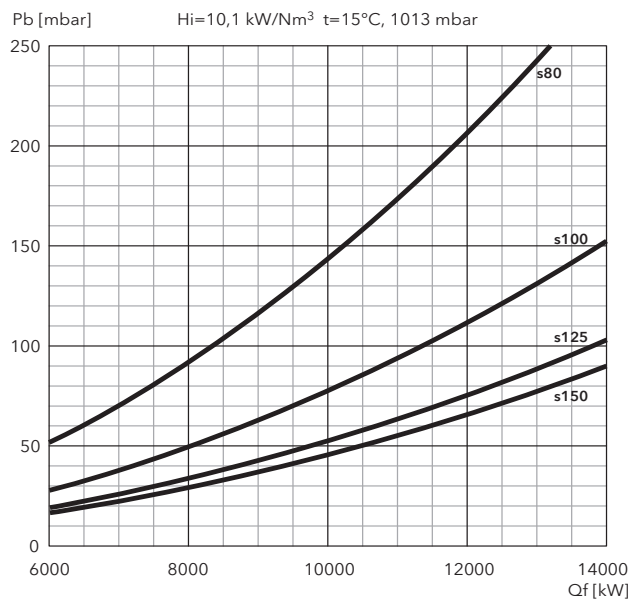

PRESSURE LOSSES (BURNER HEAD + GAS TRAIN)

N10.16000 G-E

DUNGS

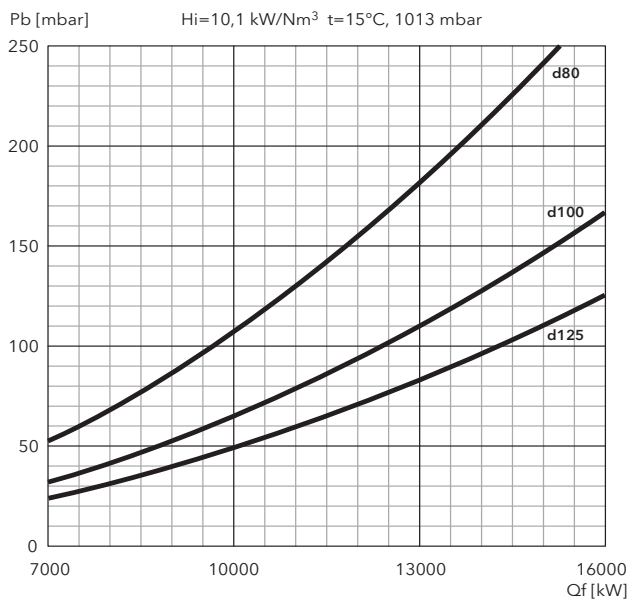

SIEMENS

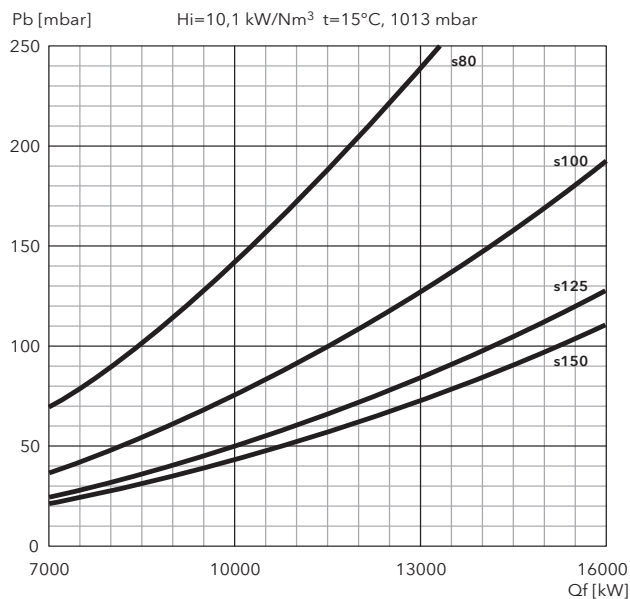

FILTERS

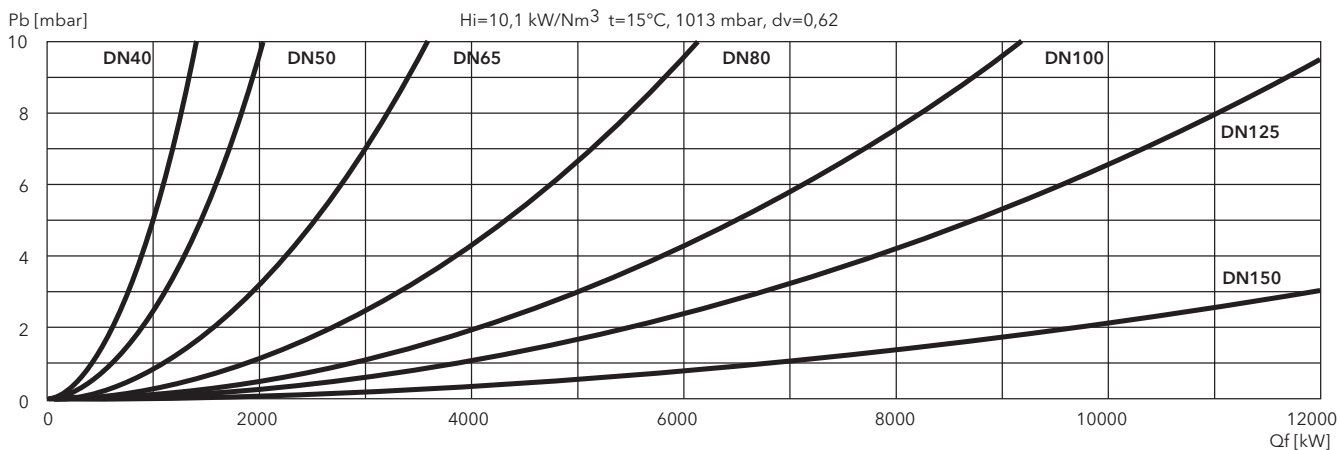

N10 G-EU2

1500 ... 16000 kW

2 stage progressive/modulating electronic (Low NOx class 3)

- **Fuels:** natural gas, low calorific value 8,83 ... 10,53 kWh/m³
- **Emission class:** Low NOx class 3 (<80 mg/kWh) according to EN676
- **Electrical power supply:** three-phase 230 V - 50 HZ
- **Protection level:** IP 40 (IP 54 as option).



TECHNICAL DATA

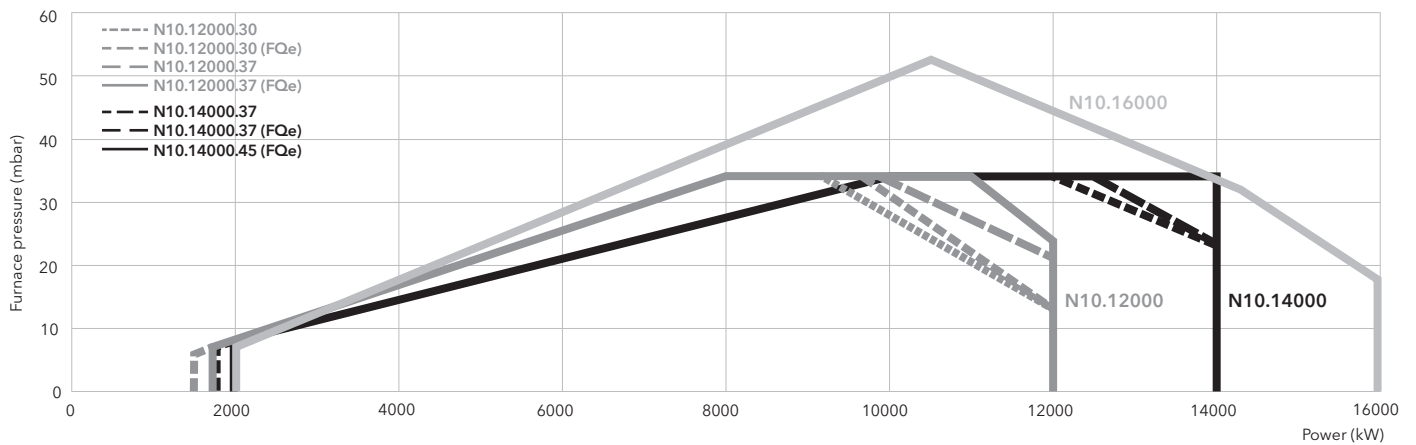

	N10.12000.30 G-EU2	N10.12000.37 G-EU2	N10.14000.37 G-EU2	N10.14000.45 G-EU2	N10.16000.45 G-EU2
Operating range	1500* - 12000 kW (*: 1750 without FQ)	1500* - 12000 kW (*: 1750 without FQ)	1750* - 14000 kW (*: 2 000 without FQ)	1750 - 14000 kW	2000 - 16000 kW
Fan motor	2950 rpm - 400/690 V 50/60 Hz - 30 kW	2950 rpm - 400/690 V 50/60 Hz - 37 kW	2950 rpm - 400/690 V 50/60 Hz - 37 kW	2950 rpm - 400/690 V 50/60 Hz - 45 kW	2950 rpm - 400/690 V 50/60 Hz - 45 kW
Acoustic level	< 97 dB(A)	< 97 dB(A)	< 97 dB(A)	< 97 dB(A)	< 97 dB(A)
CE certificate	if requested: to be carried out on site, not included in our offer				
Complete burner code	on request				

GAS TRAINS

DUNGS

Model	Code
d80	on request
d100	on request
d125	on request

SIEMENS

Model	Code
s80	on request
s100	on request
s125	on request
s150	on request

FILTERS

Model	Code
FG-DN80	3750546
FG-DN100	3750547
FG-DN125	3750548
FG-DN150	on request

Pressure drops graphs: see following pages
Dimensions of gas trains and gas filters: see pag. 202

DIMENSIONS (mm)

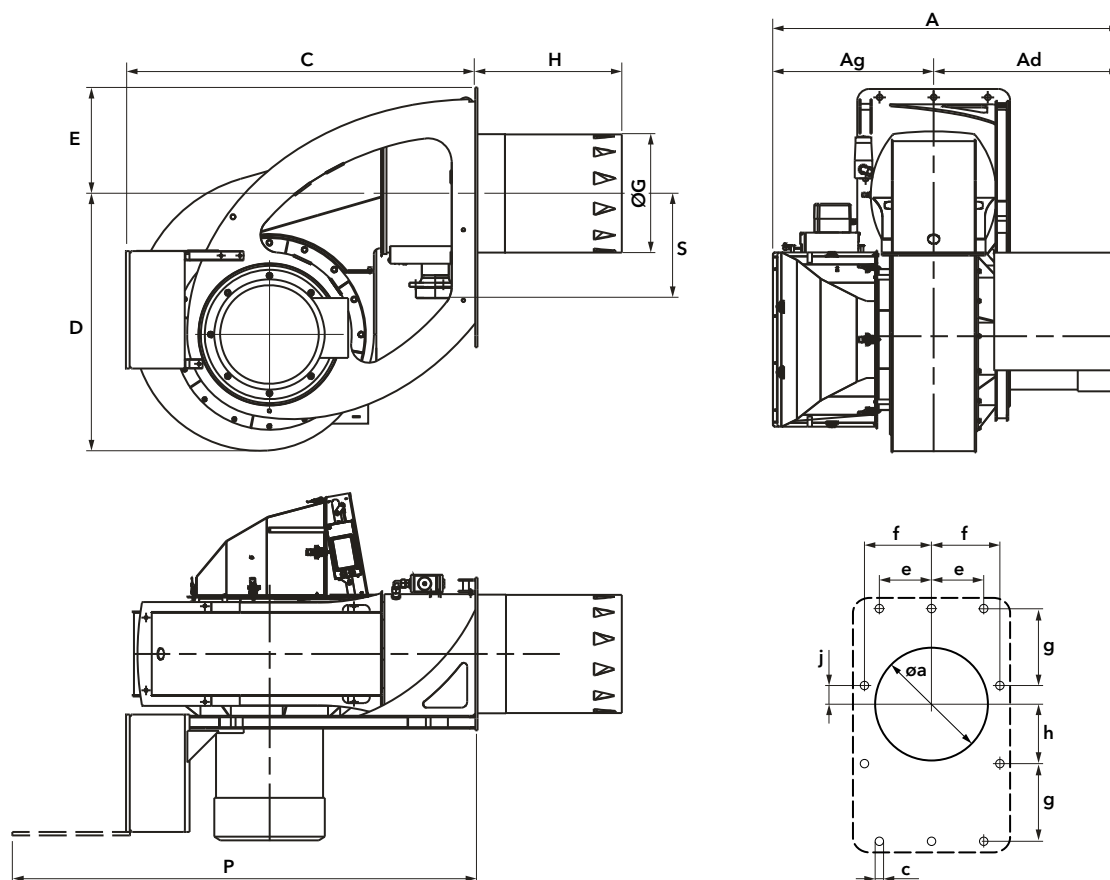

Model	A	Ad	Ag	C	D	E	ØG	H			P	S	Øa	c	e	f	g	h	j
								kN	KM	KL									
N10 G-EU2	1480	795	685	1500	1095	450	504	620	720	820	1980	446	525	M20	230	290	345	275	70

PACKAGING

The complete burner is delivered on a pallet with:

- 1 carton box for gas train and filter
- 1 carton box for boiler fixing accessories
- 1 bag with technical documentation

Models	Dimensions (mm)			Gross weight (kg)
	X	Y	Z	
N10 G-EU2	1505	2125	1545	550 (+100 transport rack)

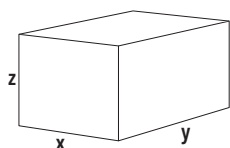

PRESSURE LOSSES (BURNER HEAD + GAS TRAIN)

N10.12000 G-EU2

DUNGS

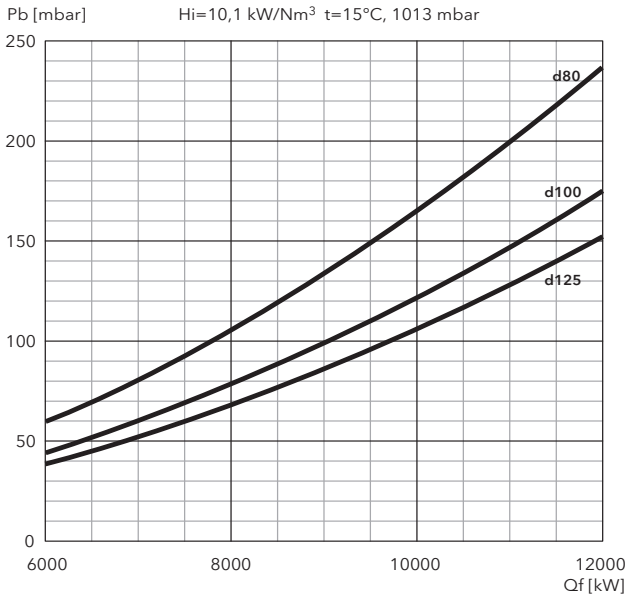

SIEMENS

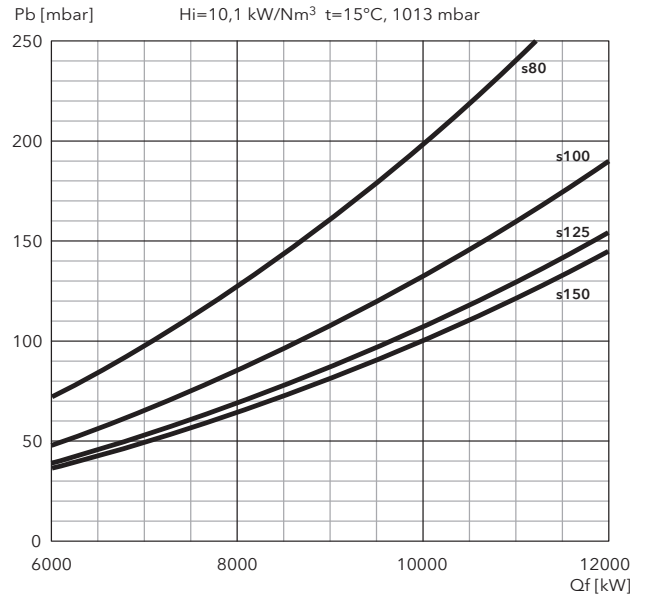

N10.14000 G-EU2

DUNGS

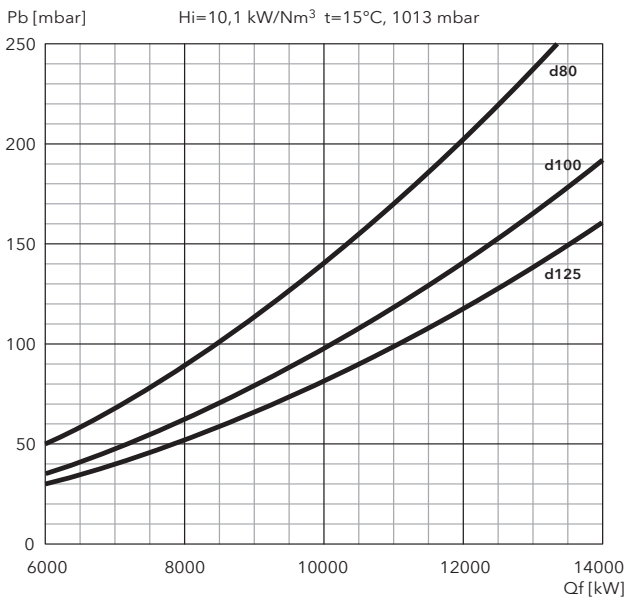

SIEMENS

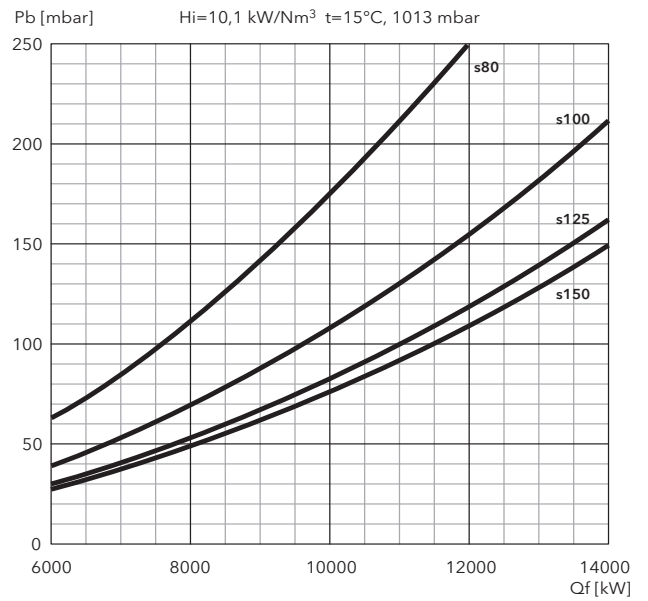

PRESSURE LOSSES (BURNER HEAD + GAS TRAIN)

N10.16000 G-EU2

DUNGS

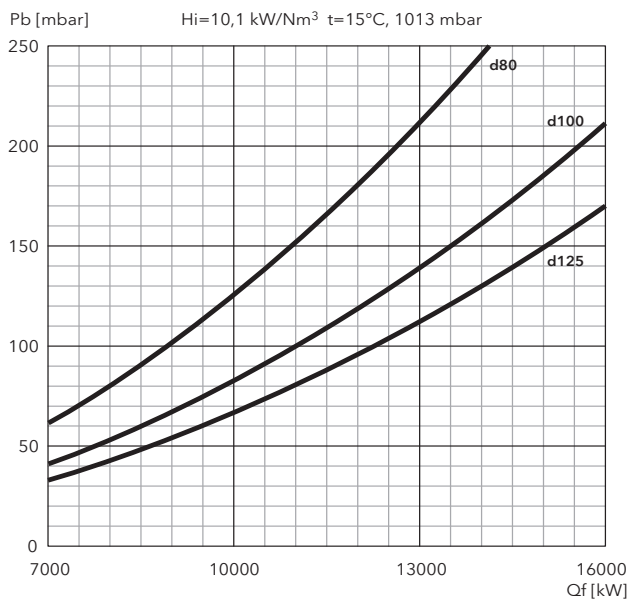

SIEMENS

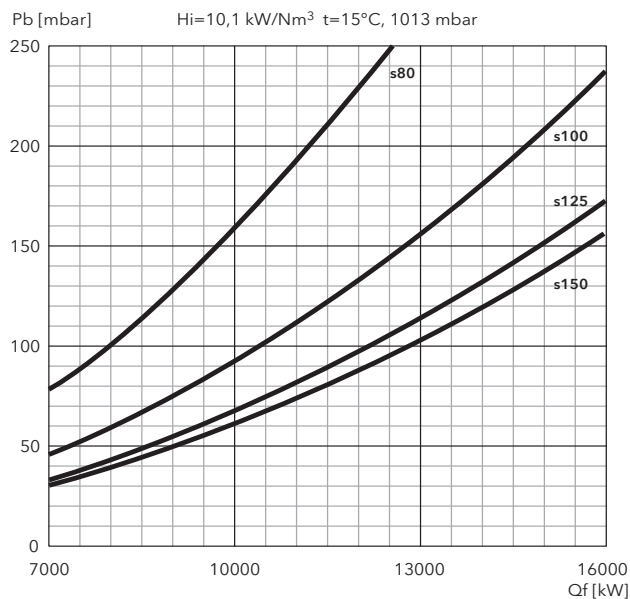

FILTERS

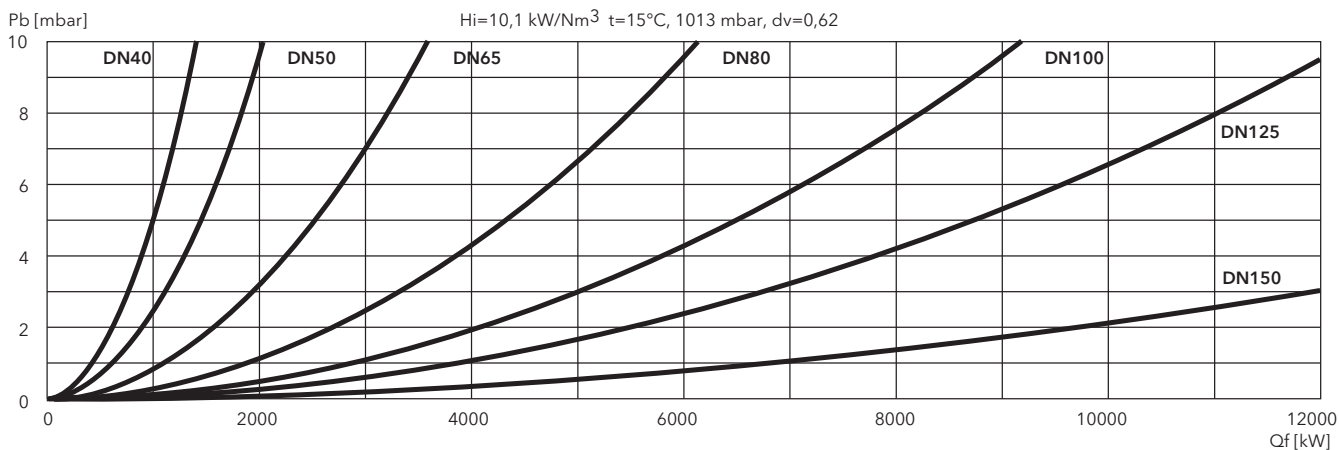

N10 GL-E

1300 ... 12000 kW

2 stage progressive/modulating electronic

- **Fuels:** natural gas, low calorific value 6,99 ... 11,39 kWh/m³;
light oil, viscosity 6 mm²/s at 20°C, low calorific value 11,86 kWh/kg
- **Emission class:** Low NOx class 2 (<120 mg/kWh) according to EN676 in gas
Low NOx class 2 (<185 mg/kWh) according to EN267 in light oil
- **Electrical power supply:** three-phase 230 V - 50 Hz
- **Protection level:** IP 40 (IP 54 as option).



TECHNICAL DATA

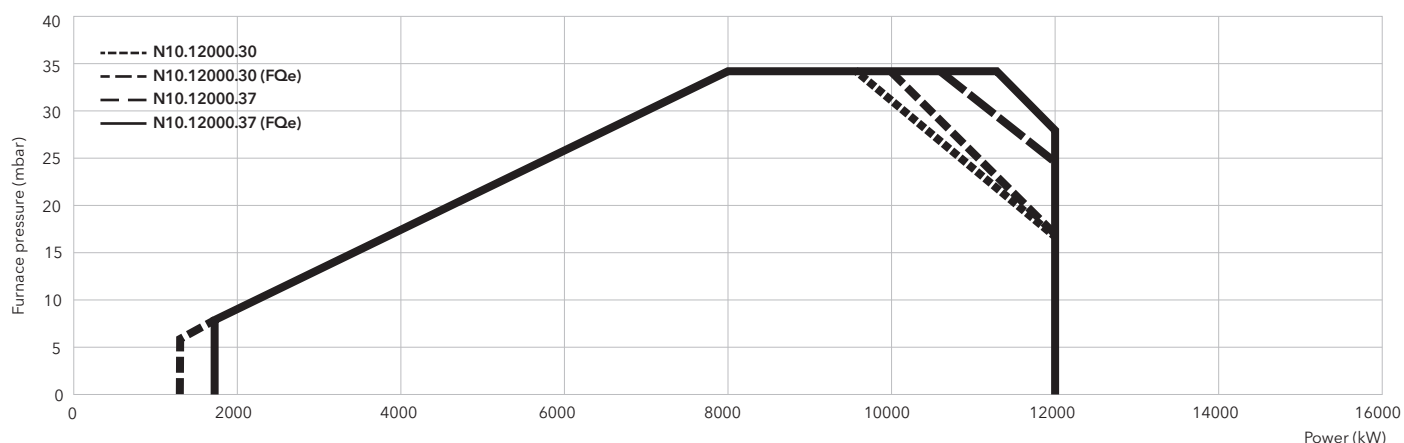

	N10.12000.30 G-EU2	N10.12000.37 G-EU2
Operating range gas	1300* - 12000 kW (*: 1750 without FQ)	1300* - 12000 kW (*: 1750 without FQ)
Operating range oil	3600 - 12000 kW	3600 - 12000 kW
Fan motor	2950 rpm - 400/690 V - 50/60 Hz - 30 kW	2950 rpm - 400/690 V - 50/60 Hz - 37 kW
Pump	2700 l/h - 4 kW	2700 l/h - 4 kW
Acoustic level	< 97 dB(A)	< 97 dB(A)
CE certificate	if requested: to be carried out on site, not included in our offer	
Complete burner code	on request	

GAS TRAINS

DUNGS

Model	Code
d80	on request
d100	on request
d125	on request

SIEMENS

Model	Code
s80	on request
s100	on request
s125	on request
s150	on request

FILTERS

Model	Code
FG-DN80	3750546
FG-DN100	3750547
FG-DN125	3750548
FG-DN150	on request

 **Pressure drops graphs:** see following pages
Dimensions of gas trains and gas filters: see pag. 202



DIMENSIONS (mm)

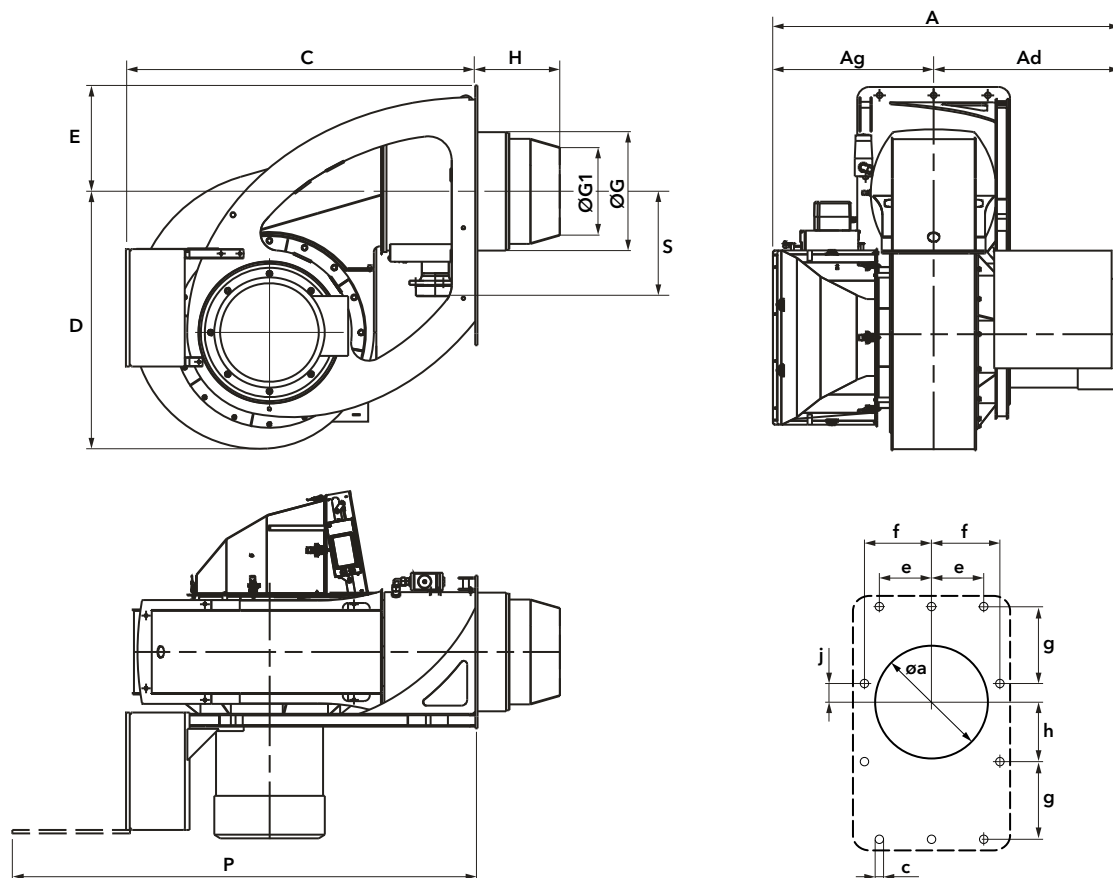

Model	A	Ad	Ag	C	D	E	ØG	ØG1	H			P	S	Øa	c	e	f	g	h	j
									kN	KM	KL									
N10 GL-E	1480	795	685	1500	1095	450	504	369	350	450	550	1980	446	525	M20	230	290	345	275	70

PACKAGING

The complete burner is delivered on a pallet with:

- 1 carton box for gas train and filter
- 1 carton box for flexible hoses
- 1 carton box for boiler fixing accessories
- 1 bag with technical documentation

Models	Dimensions (mm)			Gross weight (kg)
	X	Y	Z	
N10 GL-E	1505	2125	1545	650 (+100 transport rack)

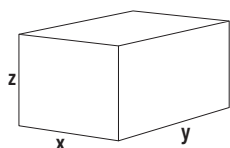

N10 GL-EUF

1500 ... 12000 kW

2 stage progressive/modulating electronic (Low NOx class 3)

- **Fuels:** natural gas, low calorific value 6,99 ... 11,39 kWh/m³;
light oil, viscosity 6 mm²/s at 20°C, low calorific value 11,86 kWh/kg
- **Emission class:** Low NOx class 3 (<80 mg/kWh) according to EN676 in gas
Low NOx class 3 (<120 mg/kWh) according to EN267 in light oil
- **Electrical power supply:** three-phase 230 V - 50 Hz
- **Protection level:** IP 40 (IP 54 as option).



TECHNICAL DATA

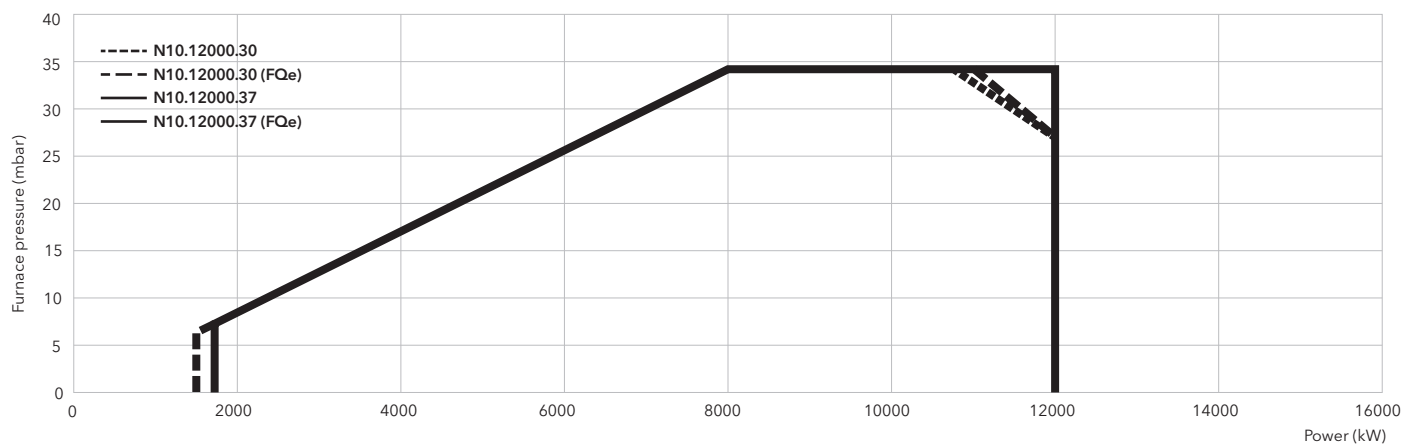

	N10.12000.30 GL-EUF	N10.12000.37 GL-EUF
Operating range gas	1500* - 12000 kW (*: 1750 without FQ)	1500* - 12000 kW (*: 1750 without FQ)
Operating range oil	3000 - 12000 kW	3000 - 12000 kW
Fan motor	2950 rpm - 400/690 V - 50/60 Hz - 30 kW	2950 rpm - 400/690 V - 50/60 Hz - 37 kW
Pump	2200 l/h - 4 kW	2200 l/h - 4 kW
Acoustic level	< 97 dB(A)	< 97 dB(A)
CE certificate	if requested: to be carried out on site, not included in our offer	
Complete burner code	on request	

GAS TRAINS

DUNGS

Model	Code
d80	on request
d100	on request
d125	on request

SIEMENS

Model	Code
s80	on request
s100	on request
s125	on request
s150	on request

FILTERS

Model	Code
FG-DN80	3750546
FG-DN100	3750547
FG-DN125	3750548
FG-DN150	on request

 **Pressure drops graphs:** see following pages
Dimensions of gas trains and gas filters: see pag. 202

DIMENSIONS (mm)

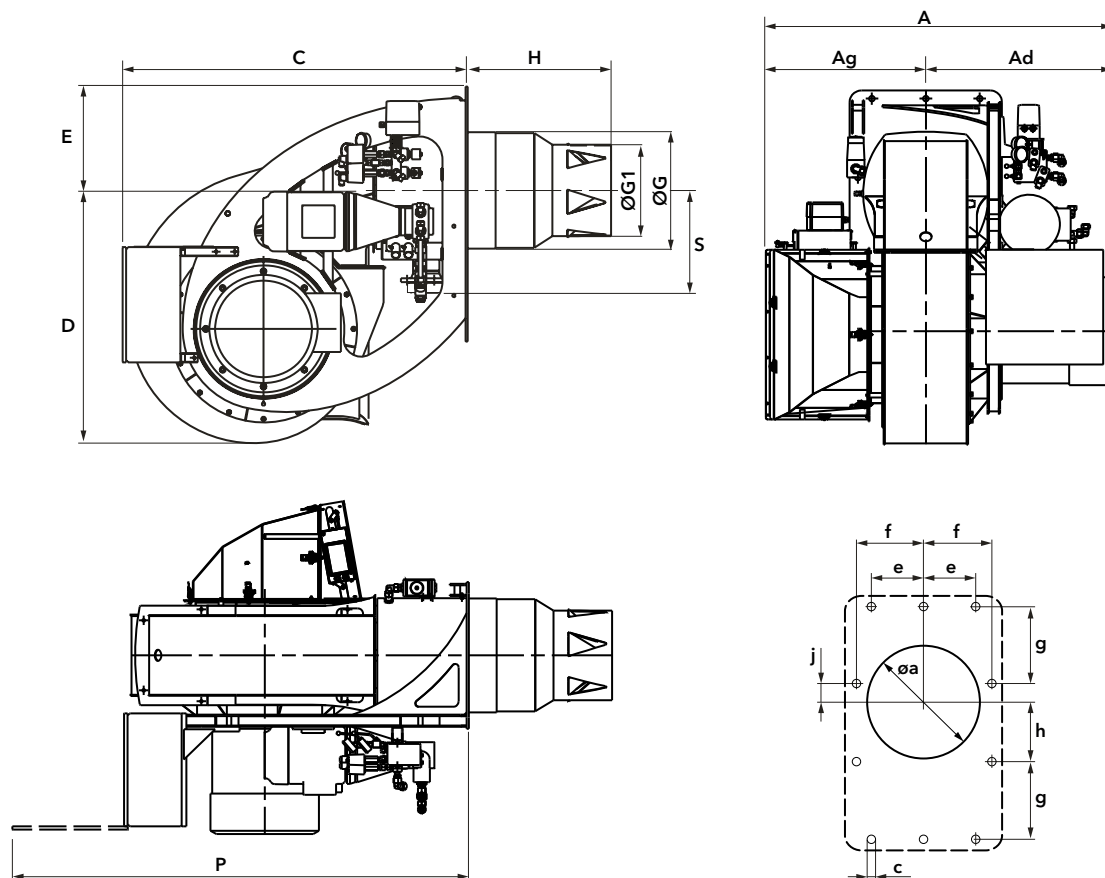

Model	A	Ad	Ag	C	D	E	ØG	ØG1	H			P	S	Øa	c	e	f	g	h	j
									kN	KM	KL									
N10 GL-EUF	1480	795	685	1500	1095	450	504	390	620	720	820	1980	446	525	M20	230	290	345	275	70

PACKAGING

The complete burner is delivered on a pallet with:

- 1 carton box for gas train and filter
- 1 carton box for flexible hoses
- 1 carton box for boiler fixing accessories
- 1 bag with technical documentation

Models	Dimensions (mm)			Gross weight (kg)
	X	Y	Z	
N10 GL-EUF	1505	2125	1545	650 (+100 transport rack)

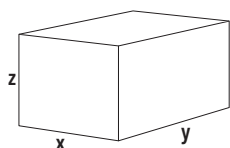

PRESSURE LOSSES (BURNER HEAD + GAS TRAIN)

N10.12000 GL-E

DUNGS

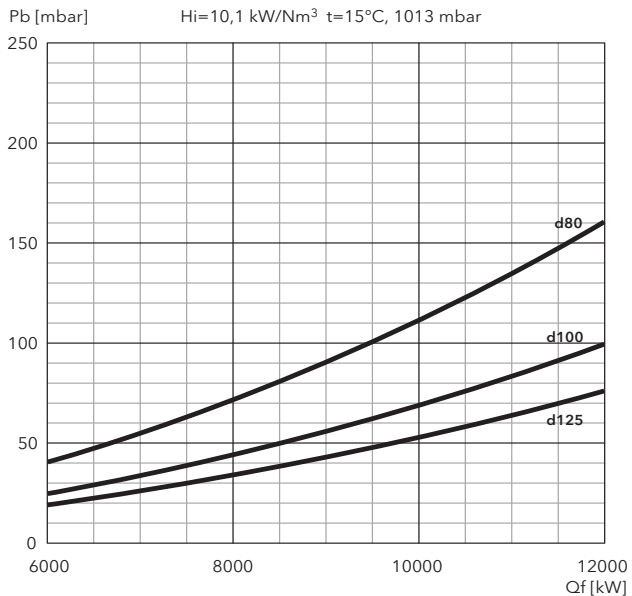

SIEMENS

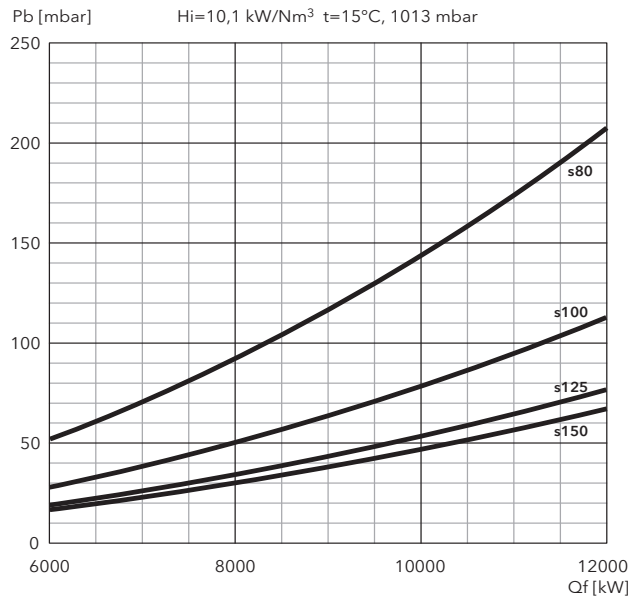

FILTERS

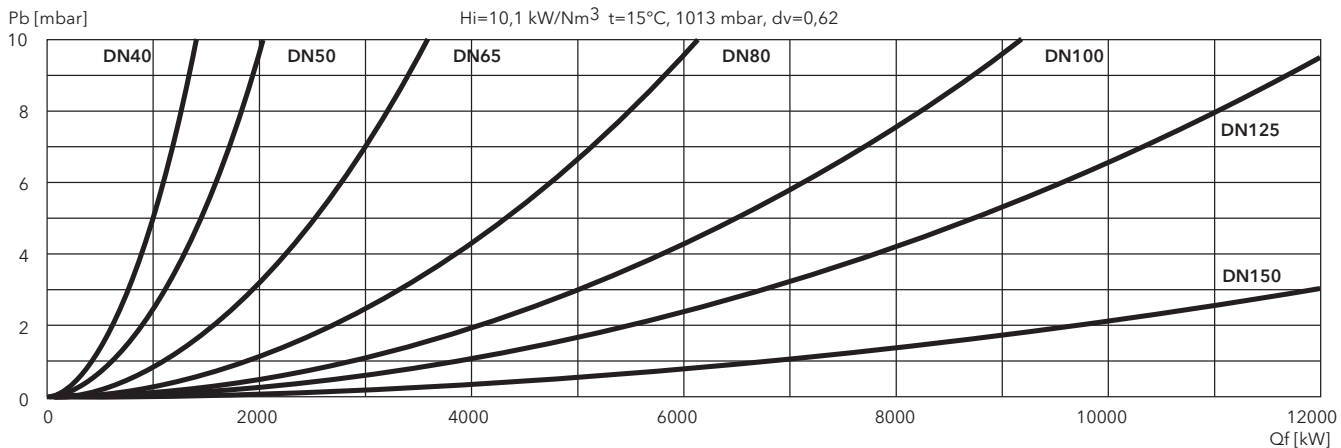

PRESSURE LOSSES (BURNER HEAD + GAS TRAIN)

N10.12000 GL-EUF

DUNGS

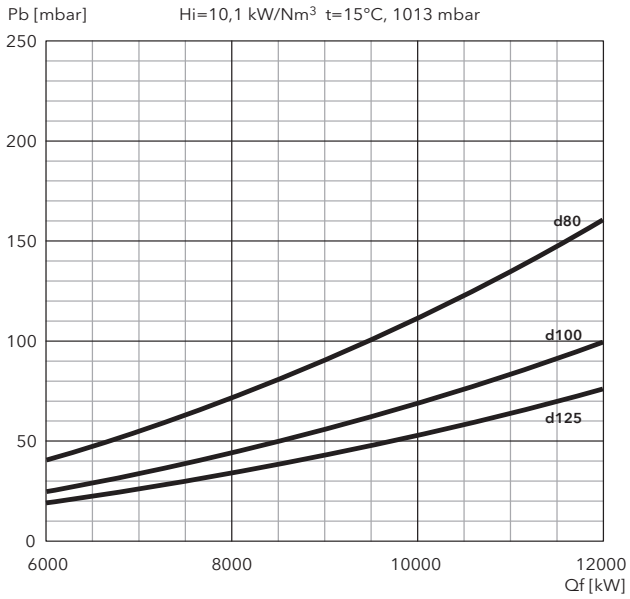

SIEMENS

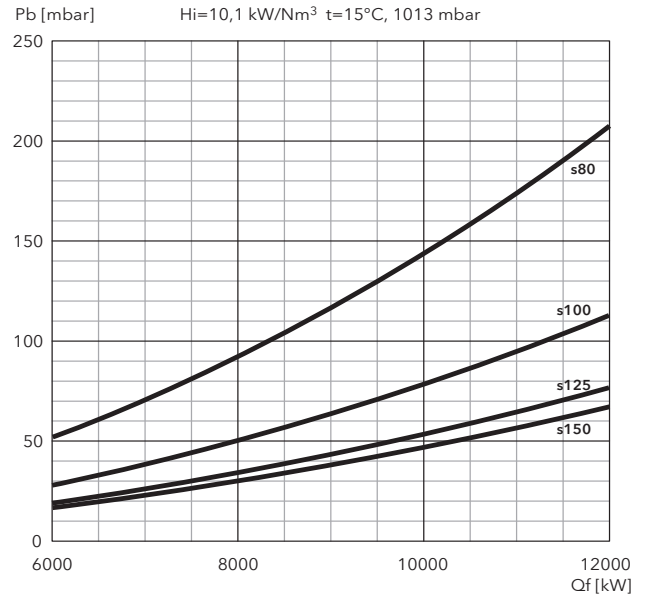

FILTERS

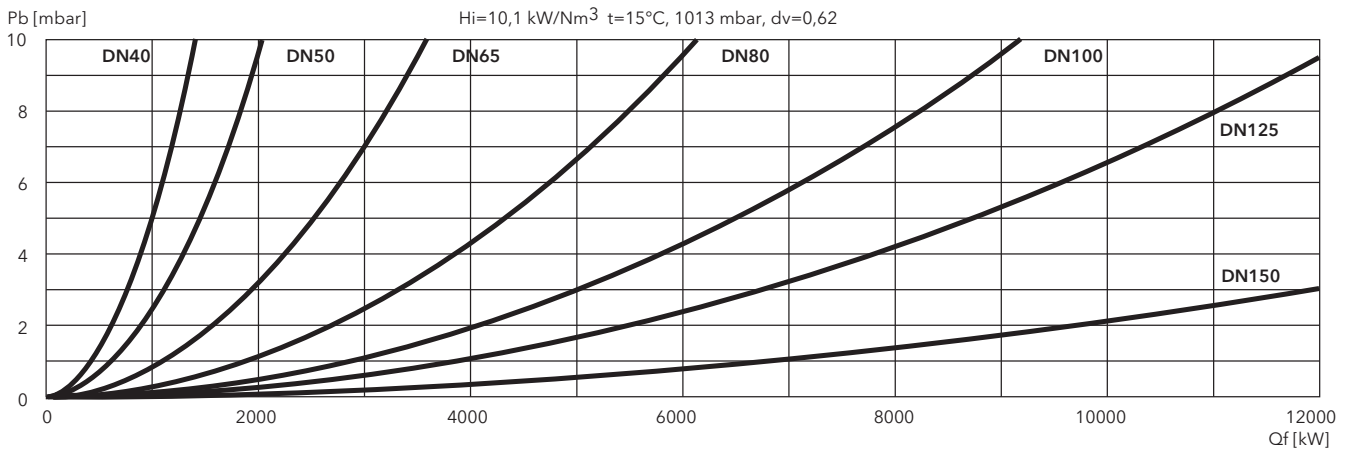

N10 L-E

3600 ... 12000 kW

2 stage progressive/modulating electronic

- **Fuels:** light oil, viscosity 6 mm²/s at 20°C, net calorific value 11,86 kWh/kg
- **Emission class:** Low NO_x class 2 (<185 mg/kWh) according to EN267 in light oil
- **Electrical power supply:** three-phase 230 V - 50 Hz
- **Protection level:** IP 40 (IP 54 as option).



TECHNICAL DATA

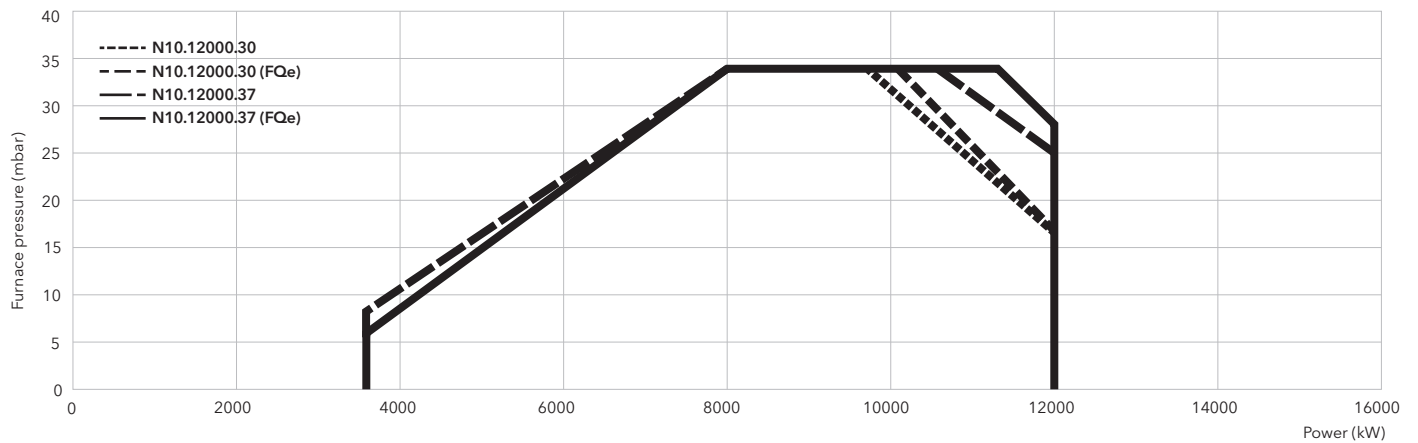

	N10.12000.30 L-E	N10.12000.37 L-E
Operating range	3 600 - 12 000 kW	3 600 - 12 000 kW
Fan motor	2 950 rpm - 400/690 V - 50/60 Hz - 30 kW	2 950 rpm - 400/690 V - 50/60 Hz - 37 kW
Pump	2 200 l/h - 4 kW	2 200 l/h - 4 kW
Acoustic level	< 97 dB(A)	< 97 dB(A)
CE certificate	if requested: to be carried out on site, not included in our offer	
Complete burner code	on request	

DIMENSIONS (mm)

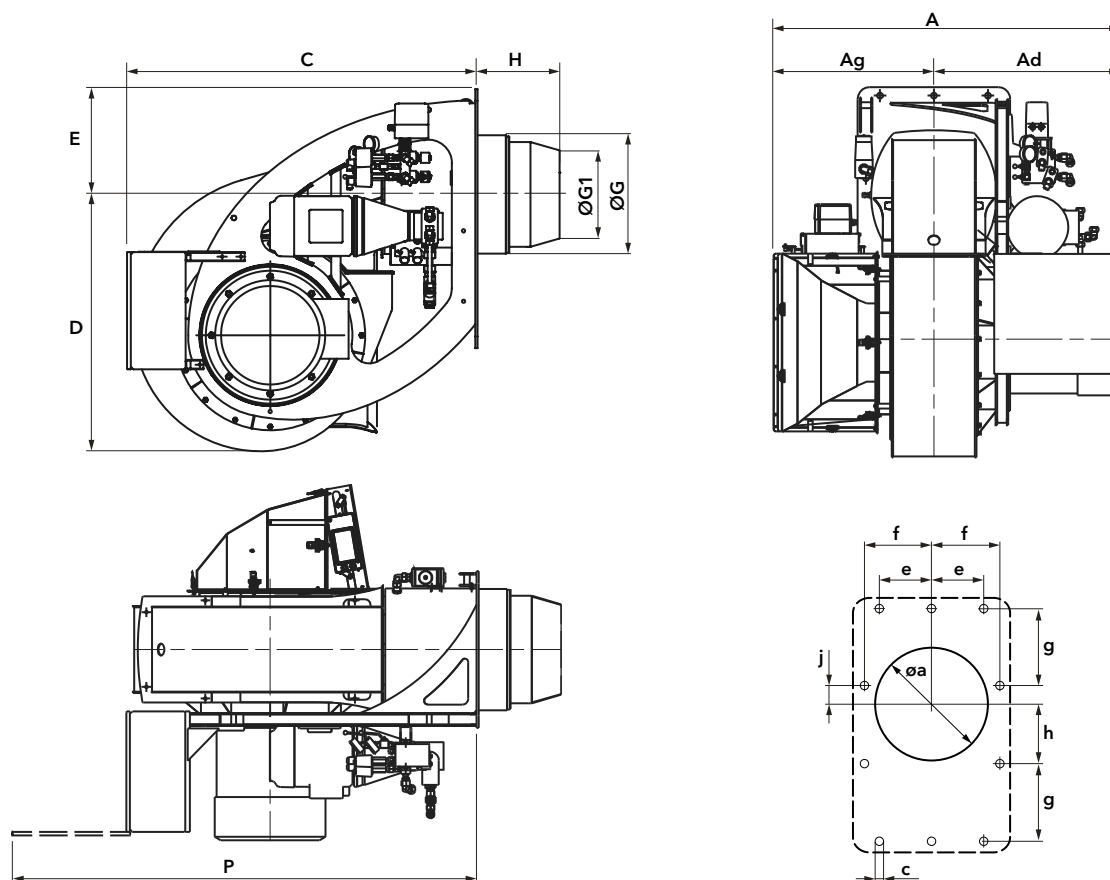

Model	A	Ad	Ag	C	D	E	ØG	H			P	Øa	c	e	f	g	h	j
								kN	KM	KL								
N10 L-E	1480	795	685	1500	1095	450	504	350	450	550	1980	525	M20	230	290	345	275	70

PACKAGING

The complete burner is delivered on a pallet with:

- 1 carton box for gas train and filter
- 1 carton box for boiler fixing accessories
- 1 bag with technical documentation

Models	Dimensions (mm)			Gross weight (kg)
	X	Y	Z	
N10 L-E	1505	2125	1545	650 (+100 transport rack)

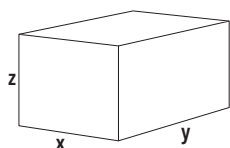

N10 L-EUF

3000 ... 16000 kW

2 stage progressive/modulating electronic (Low NOx class 3)

- **Fuels:** light oil, viscosity 6 mm²/s at 20°C, net calorific value 11,86 kWh/kg
- **Emission class:** Low NOx class 3 (<80 mg/kWh) according to EN676 in gas
Low NOx class 2 (<185 mg/kWh) according to EN267 in light oil
- **Electrical power supply:** three-phase 230 V - 50 Hz
- **Protection level:** IP 40 (IP 54 as option).



TECHNICAL DATA

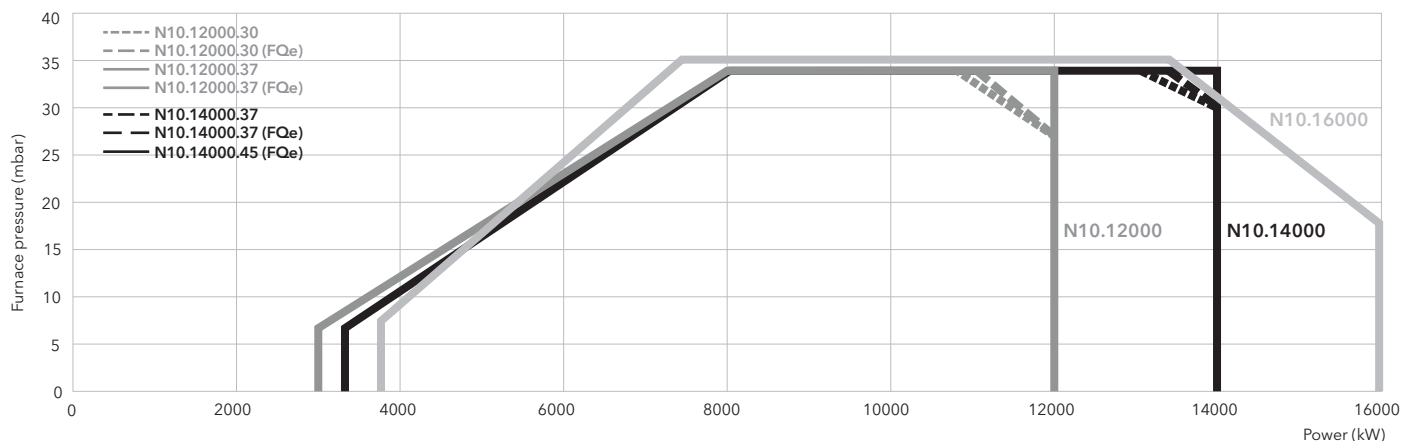

	N10.12000.30 L-EUF	N10.12000.37 L-EUF	N10.14000.37 L-EUF	N10.14000.45 L-EUF	N10.16000.45 L-EUF
Operating range	3000 - 12000 kW	3000 - 12000 kW	3300 - 14000 kW	3300 - 14000 kW	3800 - 16000 kW
Fan motor	2950 rpm - 400/690 V 50/60 Hz - 30 kW	2950 rpm - 400/690 V 50/60 Hz - 37 kW	2950 rpm - 400/690 V 50/60 Hz - 37 kW	2950 rpm - 400/690 V 50/60 Hz - 45 kW	2950 rpm - 400/690 V 50/60 Hz - 45 kW
Pump	2700 l/h - 4 kW	2700 l/h - 4 kW	2700 l/h - 4 kW	2700 l/h - 4 kW	2700 l/h - 4 kW
Acoustic level	< 97 dB(A)	< 97 dB(A)	< 97 dB(A)	< 97 dB(A)	< 97 dB(A)
CE certificate	if requested: to be carried out on site, not included in our offer				
Complete burner code	on request				

DIMENSIONS (mm)

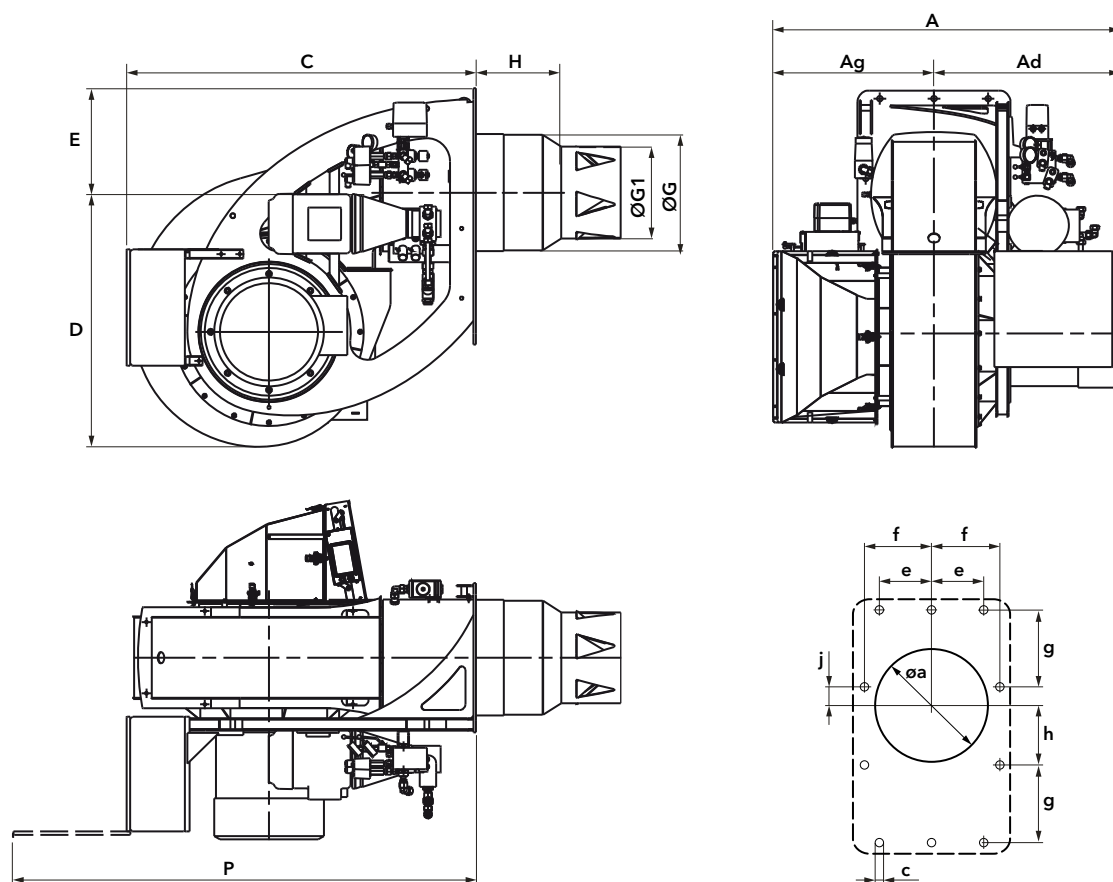

Model	A	Ad	Ag	C	D	E	ØG	ØG1	H			P	Øa	c	e	f	g	h	j
									kN	KM	KL								
N10 L-EUF	1480	795	685	1500	1095	450	504	390	620	720	820	1980	525	M20	230	290	345	275	70

PACKAGING

The complete burner is delivered on a pallet with:

- 1 carton box for gas train and filter
- 1 carton box for boiler fixing accessories
- 1 bag with technical documentation

Models	Dimensions (mm)			Gross weight (kg)
	X	Y	Z	
N10 L-EUF	1505	2125	1545	650 (+100 transport rack)

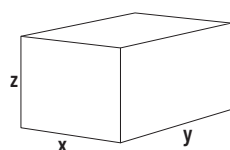

Monoblock burners from 68 to 17000 kW Heavy oil

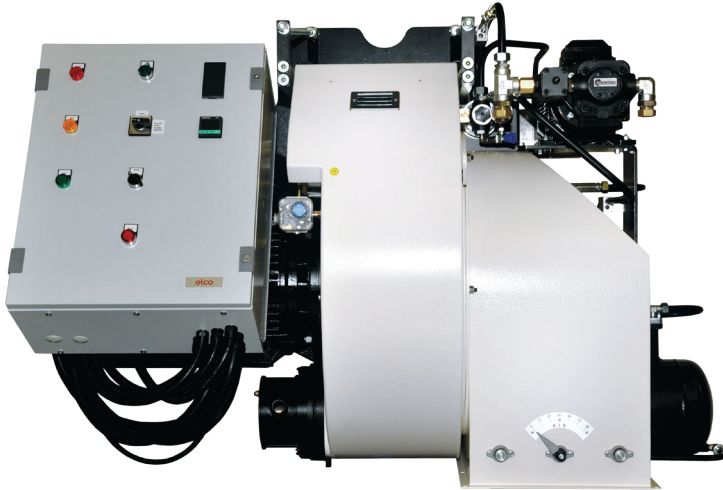

ELCO offers a wide range of heavy oil burners designed for traditional applications and industrial process applications. All models are suitable to work with heavy oil up to 50°E at 50°C.

HO-TRON range is available in different configurations with a power output covering a range from 68 kW to 17 MW.

Burners are available in the following versions:

- one stage, for HO-TRON 0 and HO-TRON 1, models up to 340 kW;
- two stages, up to the model HO-TRON 4;
- two stage progressive mechanical operation (up to 17 MW).

All burners feature easy access to the combustion component in order to simplify the maintenance operations. The maintenance activities are simplified also thanks to the slide bar system, which allows easy access to the combustion components, available on all models up to HO-TRON 6.

All models are fitted with heavy oil electric heating system on board and integrated electrical panel complete with pre-heater management system.

Ring system components for oil preparation can be designed and supply on request.

For a large extent of applications customized solutions can be offered in order to meet plants requirements.

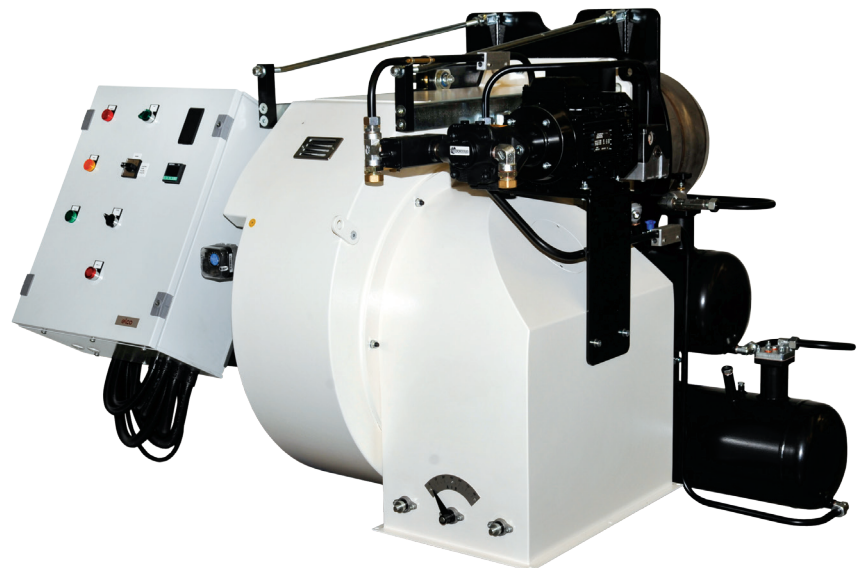

MAIN TECHNICAL FEATURES

- One stage, two stages and two stage progressive/modulating mechanical forced draught burners
- Electronic version available on request
- Fuel: heavy oil, viscosity 50°E at 50°C, low calorific value 10,97 kWh/kg
- Two combustion head lengths available
- Pump mounted on the body up to model HO-TRON 6.8500 and separated motor-pump starting from model HO-TRON 6.10500
- Electrical heavy oil heater on board (oil supply to the burner at 80°C and 3 bar)
- Additional heaters on the pipes and the valves, into the pump and the nozzle holder
- Closing of the air flap on burner shut-down
- Complete control panel mounted on the burner with electrical equipment
- Products are in compliance with EN267 European standards and with the following directives:
 - 2014/35/UE Low Voltage Directive
 - 2014/30/UE EMC Directive
 - 2006/42/EC Machinery Directive
 - 2011/65/EU RoHS2 Directive

RANGE OVERVIEW

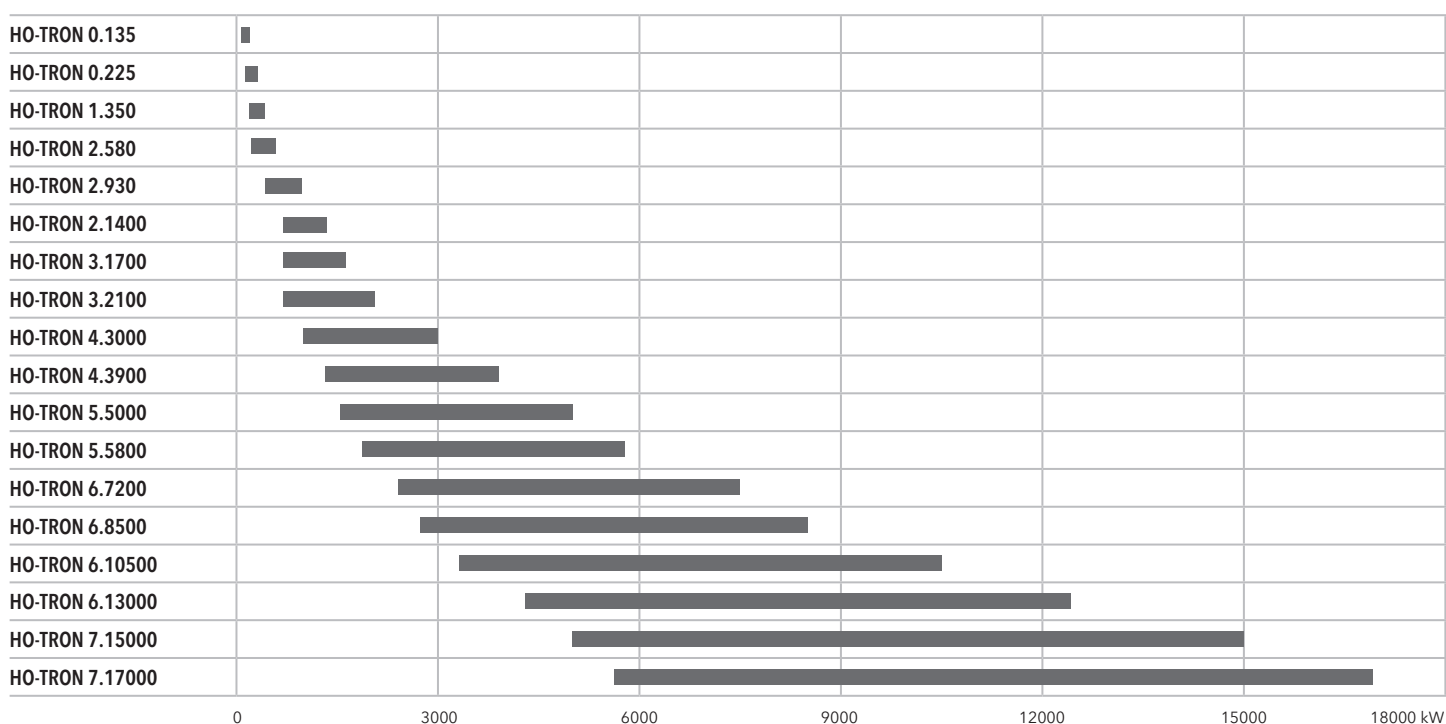

HO-TRON 0

68 ... 227 kW

1 stage

- **Fuel:** heavy oil, viscosity 50°E at 50°C, low calorific value 10,5...11,5 kWh/kg
- **Emission class:** class 1 (250 mg/kWh) according to EN267
- **Electrical power supply:** single-phase 230 V - 50 Hz
- **Protection level:** IP 42 (IP54 on request)

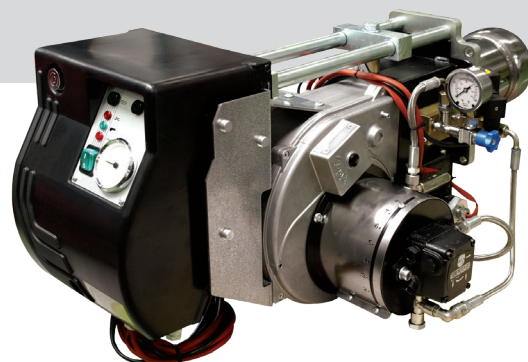

TECHNICAL DATA

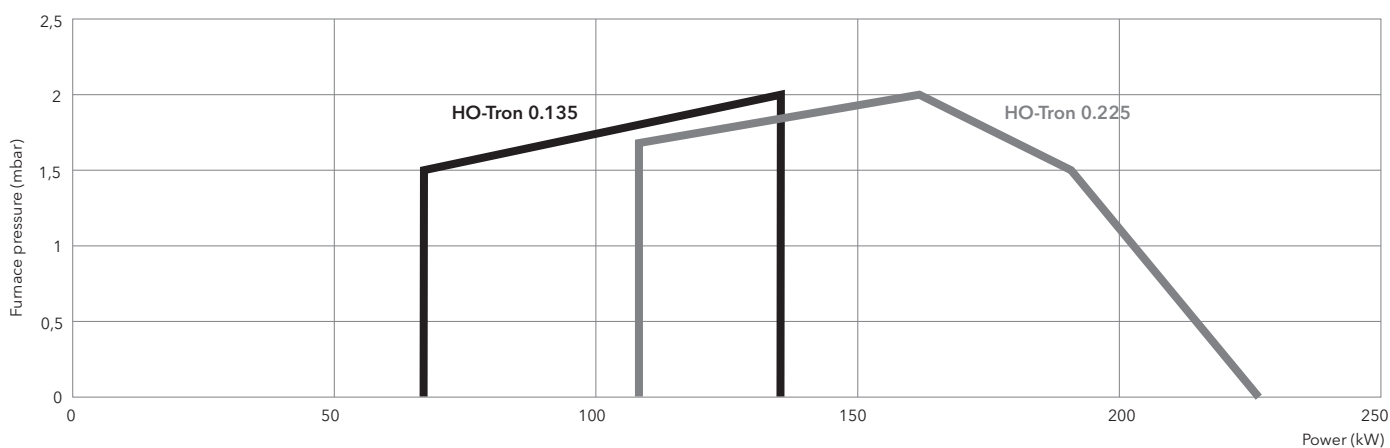

	HO-TRON 0.135		HO-TRON 0.225	
Operating range	68 - 136 kW		108 - 227 kW	
Fuel flow	6 - 12 kg/h		9,5 - 20 kg/h	
Nozzles	according to required power		according to required power	
Control box	LMO 44		LMO 44	
Fan motor	2 800 rpm - 230 V - 50 Hz - 450 W		2 800 rpm - 230 V - 50 Hz - 450 W	
Pump	D67C		D67C	
Resistance on pre-heaters	2 x 650 W		3 x 650 W	
Head lenght	KN	KL	KN	KL
Complete burner code	3 142 568	3 142 569	3 142 570	3 142 571



DIMENSIONS (mm)

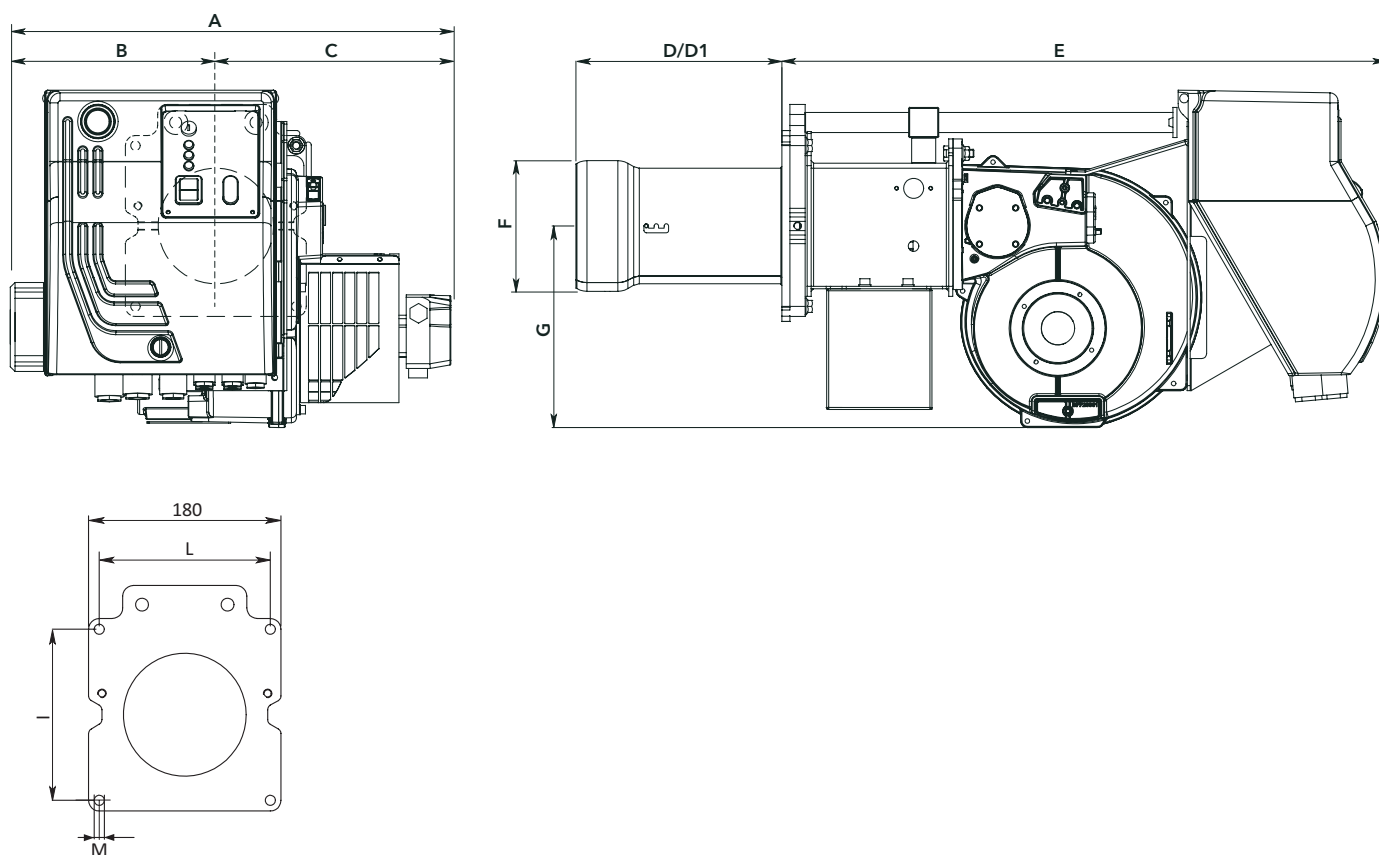

Model	A	B	C	D	D1	E	F	G	I	L	M
HO-TRON 0	520	290	230	205	325	535	130	201	160	160	M8

PACKAGING

The complete burner with combustion head is delivered in a single carton box with flexible hoses and operating manual including electrical terminal diagram and spare parts list.

Models	Dimensions (mm)		
	X	Y	Z
HO-TRON 0	900	780	700

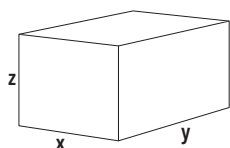

HO-TRON 1, HO-TRON 1 Z, HO-TRON 2 Z

170 ... 570 kW
1 and 2 stages

- **Fuel:** heavy oil, viscosity 50°E at 50°C, low calorific value 10,5...11,5 kWh/kg
- **Emission class:** class 1 (250 mg/kWh) according to EN267
- **Electrical power supply:** three-phase 230/400 V - 50 Hz
- **Protection level:** IP 40

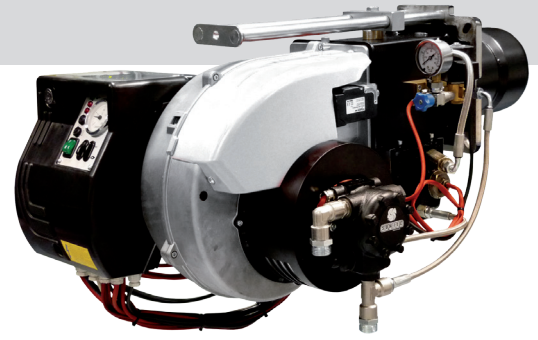

TECHNICAL DATA

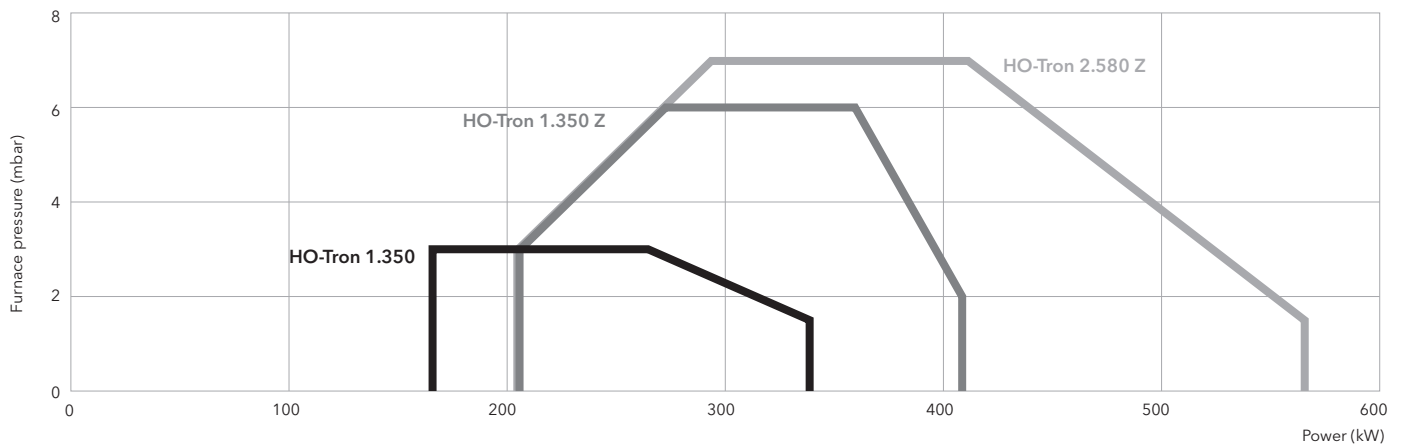

	HO-TRON 1.350		HO-TRON 1.350 Z		HO-TRON 2.580 Z	
Operating range	170 - 340 kW		205 - 410 kW		205 - 570 kW	
Fuel flow	15 - 30 kg/h		18 - 36 kg/h		18 - 50 kg/h	
Nozzles	according to required power		according to required power		according to required power	
Control box	LMO 44		LMO 44		LMO 44	
Fan motor	2 800 rpm - 230/400 V - 50 Hz - 740 W				2 800 rpm - 230/400 V - 50 Hz - 1 100 W	
Pump	E4 NC 1069		E4 NC 1069		E4 NC 1069	
Resistance on pre-heaters	3,9 kW		3,9 kW		3,9 kW	
Head lenght	KN	KL	KN	KL	KN	KL
Complete burner code	on request		on request		3 142 671	on request



DIMENSIONS (mm)

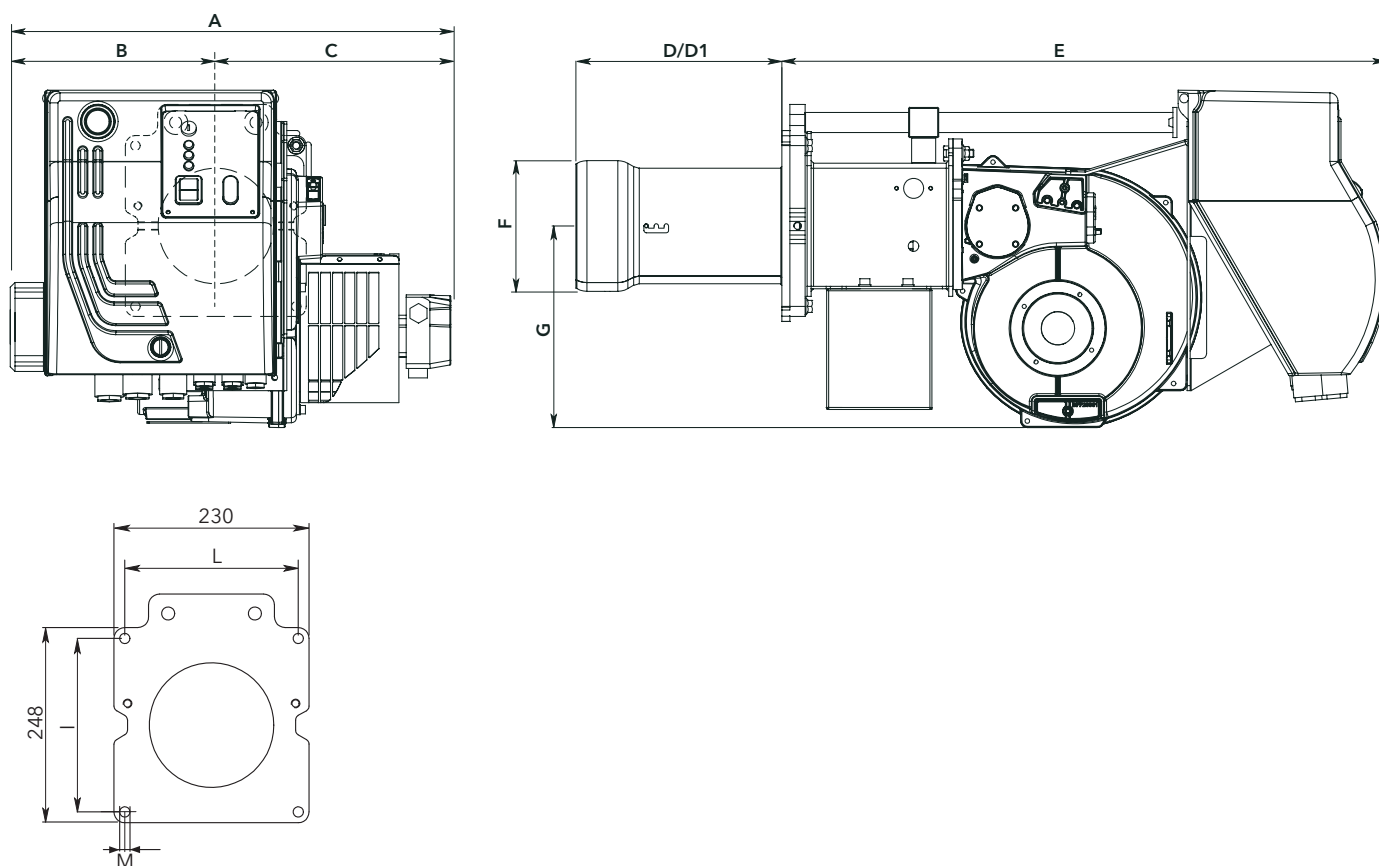

Model	A	B	C	D	D1	E	F	G	I	L	M
HO-TRON 1-2	562	302	260	205	325	653	160	280	185/200	185/200	M10

PACKAGING

The complete burner with combustion head is delivered in a single carton box with flexible hoses and operating manual including electrical terminal diagram and spare parts list.

Models	Dimensions (mm)		
	X	Y	Z
HO-TRON 1-2	900	780	700

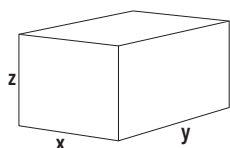

HO-TRON 2 Z

465 ... 1395 kW
2 stages

- **Fuel:** heavy oil, viscosity 50°E at 50°C, low calorific value 10,5...11,5 kWh/kg.
- **Emission class:** class 1 (250 mg/kWh) according to EN267
- **Electrical power supply:** three-phase 230/400 V - 50 Hz
- **Protection level:** IP 42 (IP54 on request).



TECHNICAL DATA

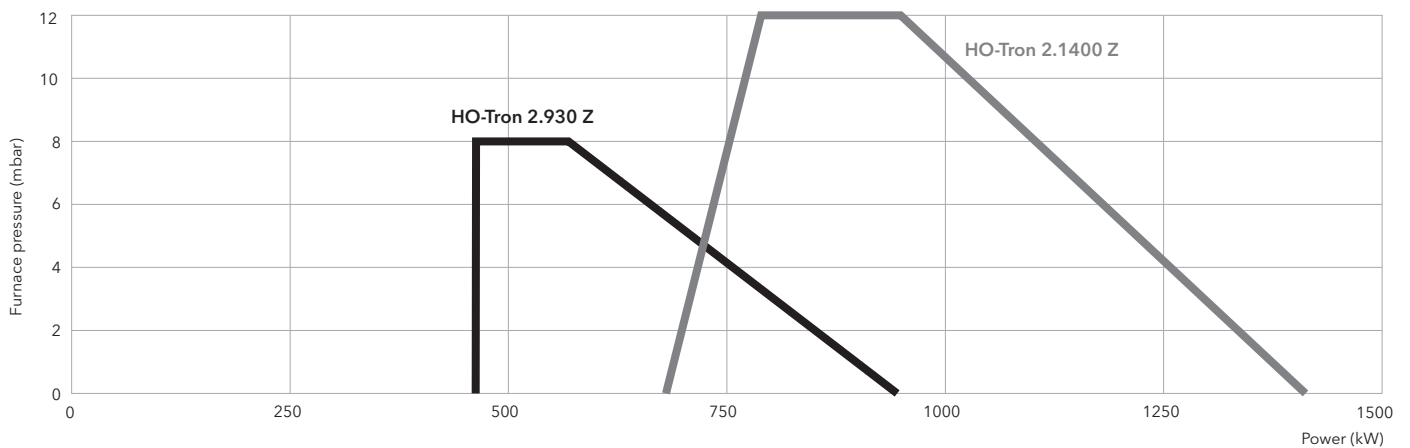

	HO-TRON 2.930 Z		HO-TRON 2.1400 Z	
Operating range	465 - 930 kW		682 - 1 395 kW	
Fuel flow	41 - 82 kg/h		60 - 122 kg/h	
Nozzles	according to required power		according to required power	
Control box	LMO 44		LMO 44	
Fan motor	2 800 rpm - 230 V - 50 Hz - 1,5 kW		2 800 rpm - 230 V - 50 Hz - 2,2 kW	
Pump	E4 NC 1069		E4 NC 1069	
Resistance on pre-heaters	4,65 kW		7,05 kW	
Head lenght	KN	KL	KN	KL
Complete burner code	3 142 672	3 142 215	3 142 673	3 143 193



DIMENSIONS (mm)

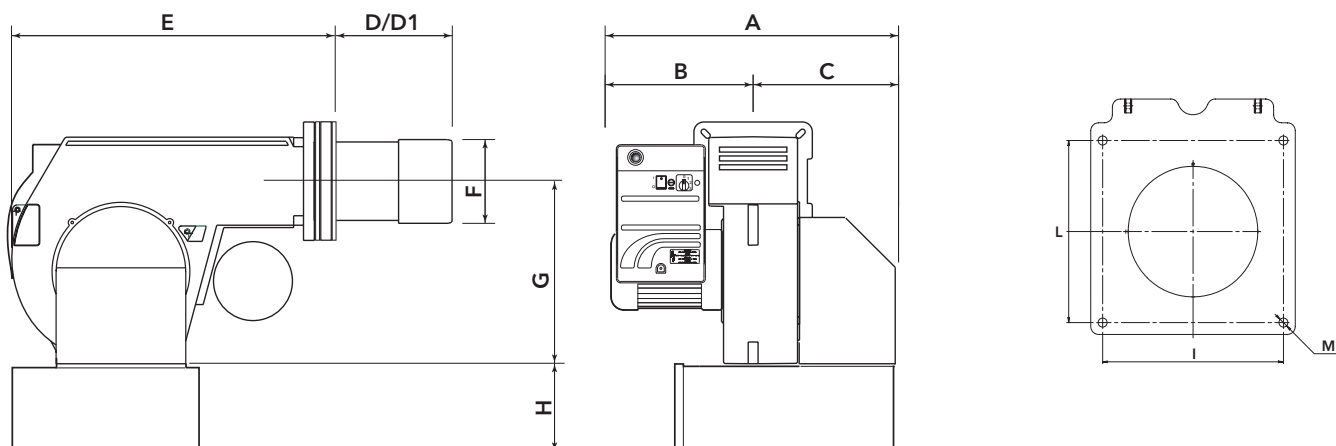

Model	A	B	C	D	D1	E	F	G	H	I	L	M
HO-TRON 2	758	388	370	170	310	600	185	390	210*	190	190	M10

* optional silencer

PACKAGING

The complete burner with combustion head is delivered in a single carton box with flexible hoses and operating manual including electrical terminal diagram and spare parts list.

Models	Dimensions (mm)		
	X	Y	Z
HO-TRON 2	1100	780	700

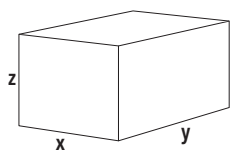

HO-TRON 3 Z

682 ... 2093 kW
2 stages

- **Fuel:** heavy oil, viscosity 50°E at 50°C, low calorific value 10,5...11,5 kWh/kg.
- **Emission class:** class 1 (250 mg/kWh) according to EN267
- **Electrical power supply:** three-phase 230/400 V - 50 Hz
- **Protection level:** IP 42 (IP54 on request).

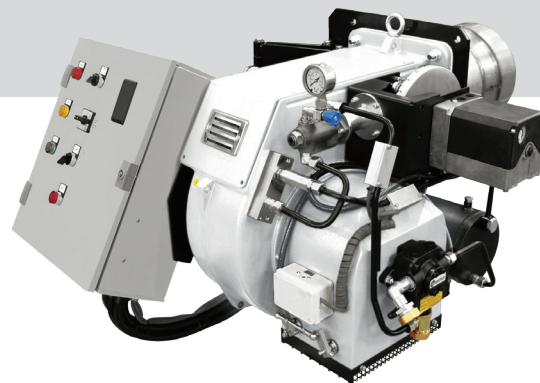

TECHNICAL DATA

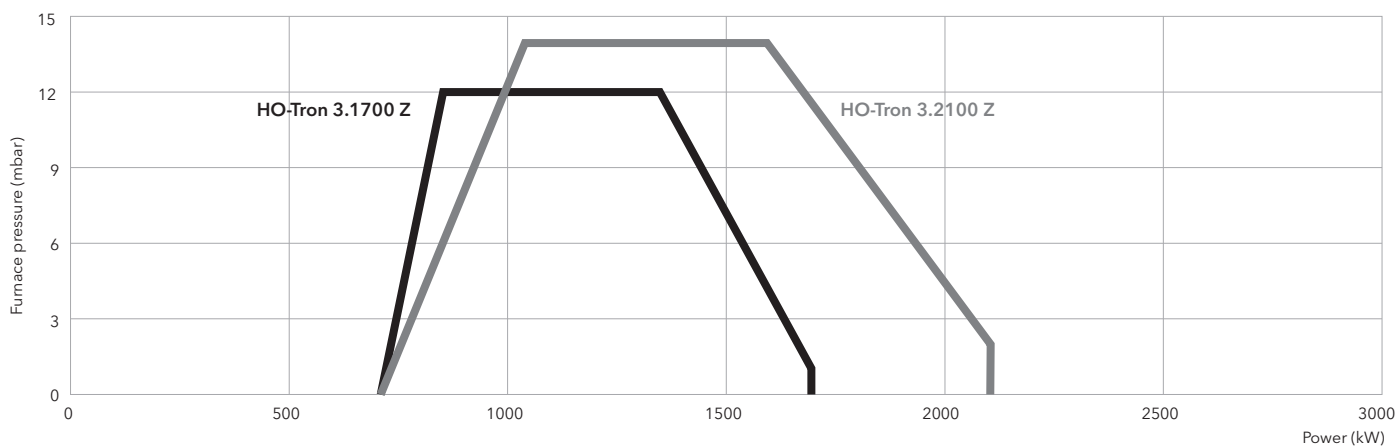

	HO-TRON 3.1700 Z		HO-TRON 3.2100 Z	
Operating range	682 - 1 700 kW		682 - 2 093 kW	
Fuel flow	60 - 148 kg/h		60 - 184 kg/h	
Nozzles	according to required power		according to required power	
Control box	LMO 44		LMO 44	
Fan motor	2 800 rpm - 230/400 V - 50 Hz - 3 kW		2 800 rpm - 230/400 V - 50 Hz - 4 kW	
Pump	E6 NC 1069		E6 NC 1069	
Resistance on pre-heaters	9 kW		10,5 kW	
Head lenght	KN	KL	KN	KL
Complete burner code	3 142 675	3 143 194	3 142 441	3 142 677

DIMENSIONS (mm)

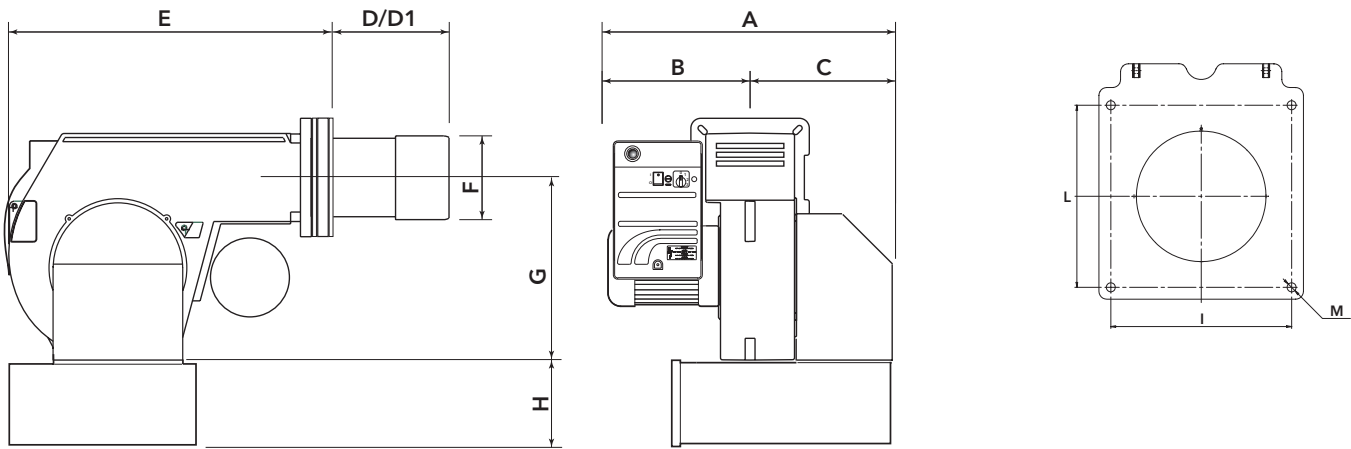

Model	A	B	C	D	D1	E	F	G	H	I	L	M
HO-TRON 3.1700 Z	920	450	470	280	480	710	250	420	260*	315	315	M14
HO-TRON 3.2100 Z	920	450	470	280	480	710	270	420	260*	315	315	M14

PACKAGING

The complete burner with combustion head is delivered in a single carton box with flexible hoses and operating manual including electrical terminal diagram and spare parts list.

Models	Dimensions (mm)		
	X	Y	Z
HO-TRON 3	1370	1140	950

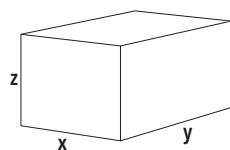

HO-TRON 4 Z/Z3

1000 ... 3900 kW
2 stages

- **Fuel:** heavy oil, viscosity 50°E at 50°C, low calorific value 10,5...11,5 kWh/kg.
- **Emission class:** class 1 (250 mg/kWh) according to EN267
- **Electrical power supply:** three-phase 230/400 V - 50 Hz
- **Protection level:** IP 42 (IP54 on request).

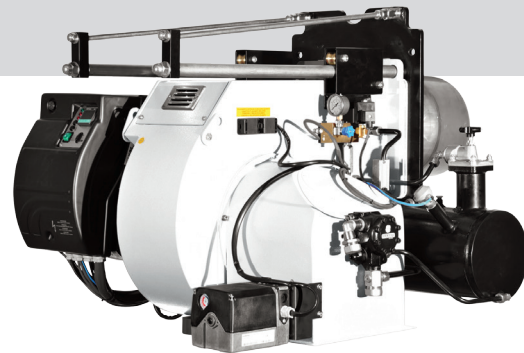

TECHNICAL DATA

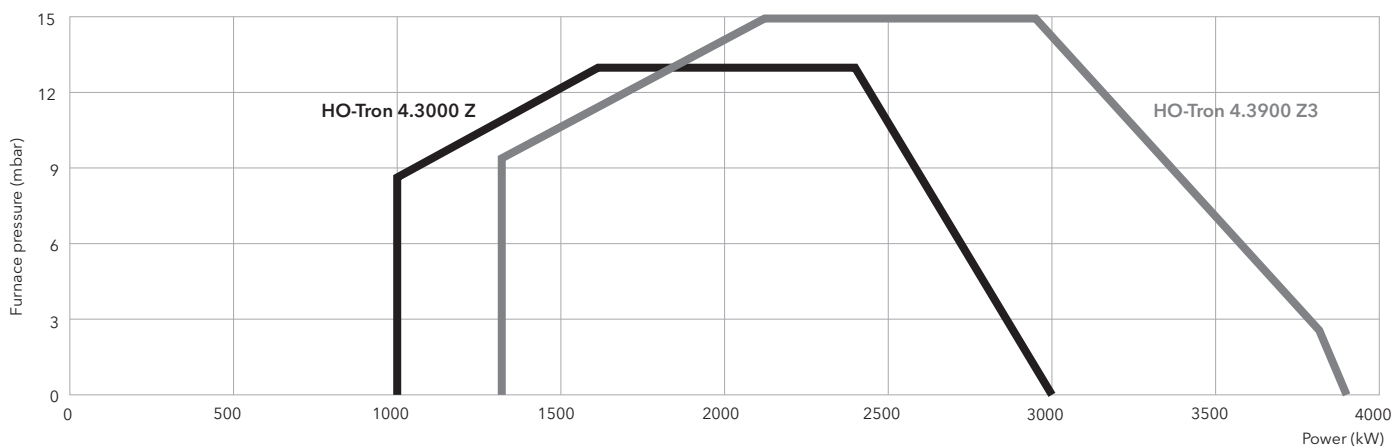

	HO-TRON 4.3000 Z		HO-TRON 4.3900 Z3	
Operating range	1 000 - 3 000 kW		1 300 - 3 900 kW	
Fuel flow	88,5 - 264 kg/h		115 - 343 kg/h	
Nozzles	according to required power		according to required power	
Control box	LMO 44		LMO 44	
Fan motor	2 800 rpm - 230/400 V - 50 Hz - 7,5 kW		2 800 rpm - 230/400 V - 50 Hz - 9 kW	
Pump	E7 NC 1069		E7 NC 1069	
Resistance on pre-heaters	18 kW		21 kW	
Head lenght	KN	KL	KN	KL
Complete burner code	3 142 678	3 142 679	3 142 680	3 142 681

DIMENSIONS (mm)

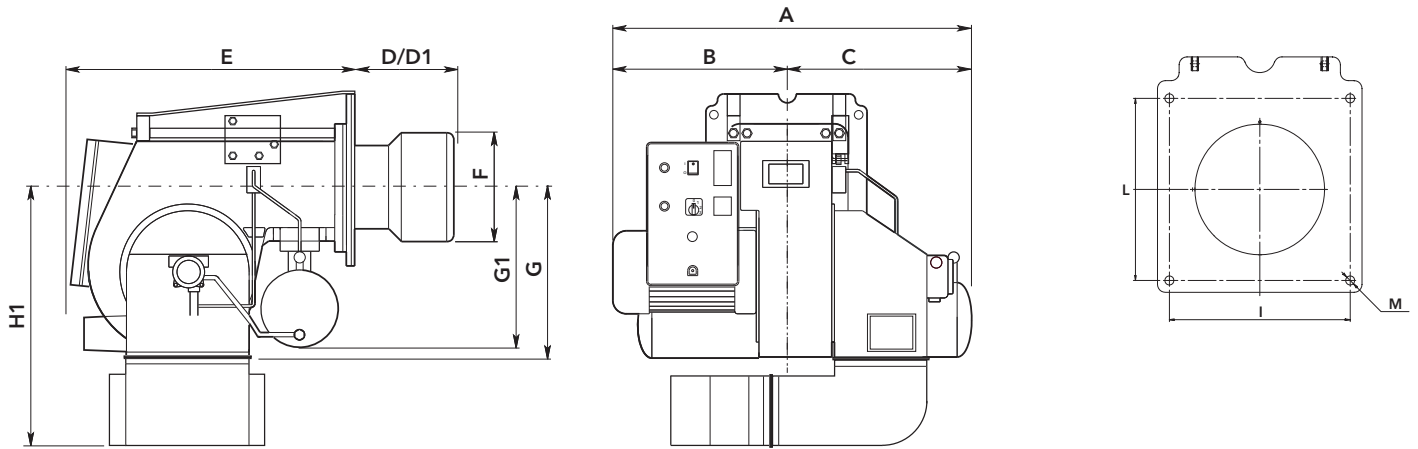

Model	A	B	C	D	D1	E	F	G	G1	H1	I	L	M
HO-TRON 4.3000 Z	1205	603	602	350	600	925	290	470	430	746	400	400	M16
HO-TRON 4.3900 Z3	1205	603	602	350	600	925	320	470	430	746	400	400	M16

PACKAGING

The complete burner with combustion head is delivered in a single carton box with flexible hoses and operating manual including electrical terminal diagram and spare parts list.

Models	Dimensions (mm)		
	X	Y	Z
HO-TRON 4	1580	1580	1050

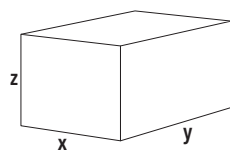

HO-TRON 4 R

1000 ... 3900 kW

2 stage progressive/modulating mechanical

- **Fuel:** heavy oil, viscosity 50°E at 50°C, low calorific value 10,5...11,5 kWh/kg.
- **Emission class:** class 1 (250 mg/kWh) according to EN267
- **Electrical power supply:** three-phase 230/400 V - 50 Hz
- **Protection level:** IP 42 (IP54 on request).

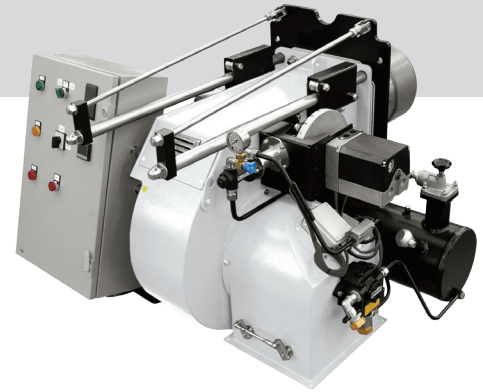

TECHNICAL DATA

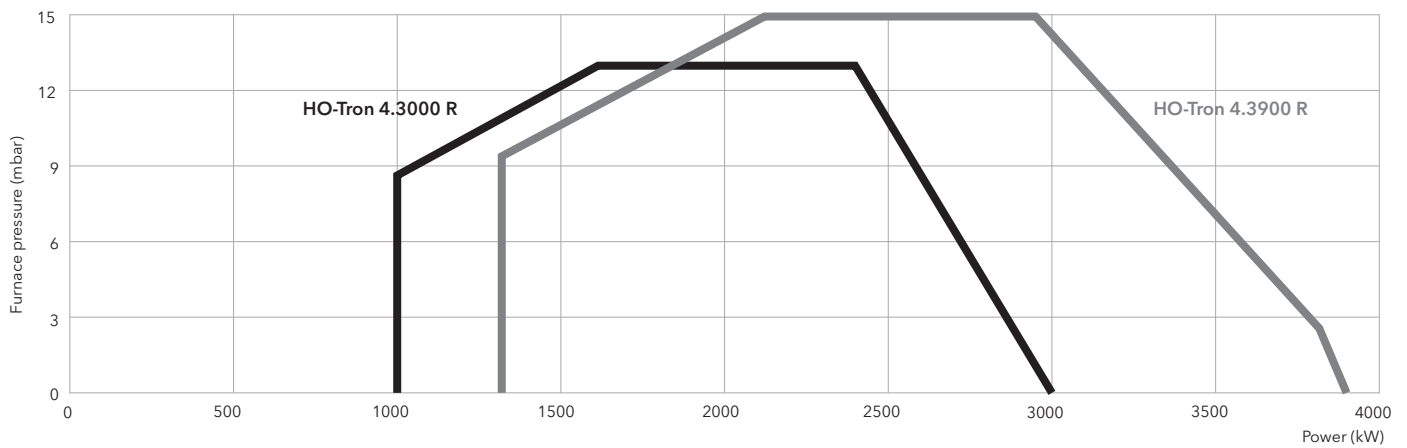

	HO-TRON 4.3000 R		HO-TRON 4.3900 R	
Operating range	1 000 - 3 000 kW		1 300 - 3 900 kW	
Fuel flow	88,5 - 264 kg/h		115 - 343 kg/h	
Nozzles	according to required power		according to required power	
Control box	LAL 1.25		LAL 1.25	
Fan motor	2 800 rpm - 230/400 V - 50 Hz - 7,5 kW		2 800 rpm - 230/400 V - 50 Hz - 9 kW	
Pump	TA 3C		TA 3C	
Resistance on pre-heaters	18 kW		21 kW	
Head lenght	KN	KL	KN	KL
Complete burner code	on request	on request	on request	on request

DIMENSIONS (mm)

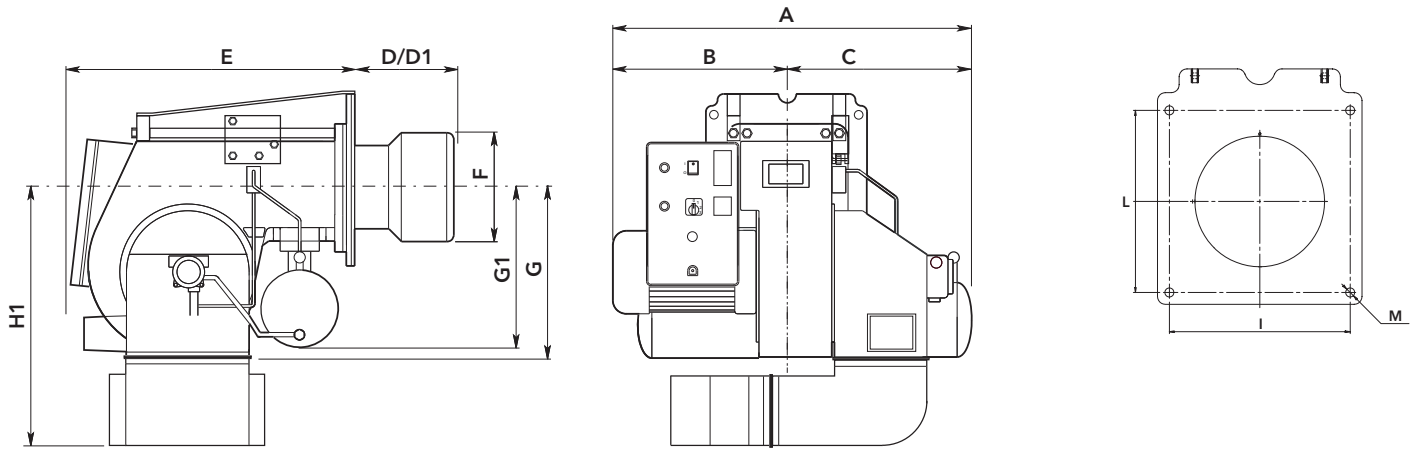

Model	A	B	C	D	D1	E	F	G	G1	H1	I	L	M
HO-TRON 4.3000 R	1205	603	602	350	600	925	290	470	430	746	400	400	M16
HO-TRON 4.3900 R	1205	603	602	350	600	925	320	470	430	746	400	400	M16

PACKAGING

The complete burner with combustion head is delivered in a single carton box with flexible hoses and operating manual including electrical terminal diagram and spare parts list.

Models	Dimensions (mm)		
	X	Y	Z
HO-TRON 4 R	1580	1580	1050

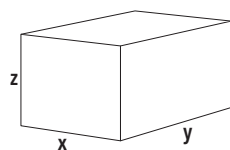

HO-TRON 5 R

1578 ... 5800 kW

2 stage progressive/modulating mechanical

- **Fuel:** heavy oil, viscosity 50°E at 50°C, low calorific value 10,5...11,5 kWh/kg.
- **Emission class:** class 1 (250 mg/kWh) according to EN267
- **Electrical power supply:** three-phase 230/400 V - 50 Hz
- **Protection level:** IP 42 (IP54 on request).

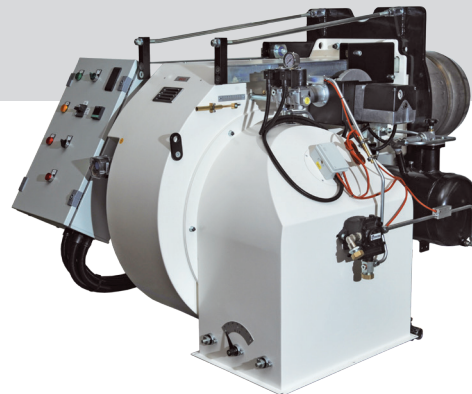

TECHNICAL DATA

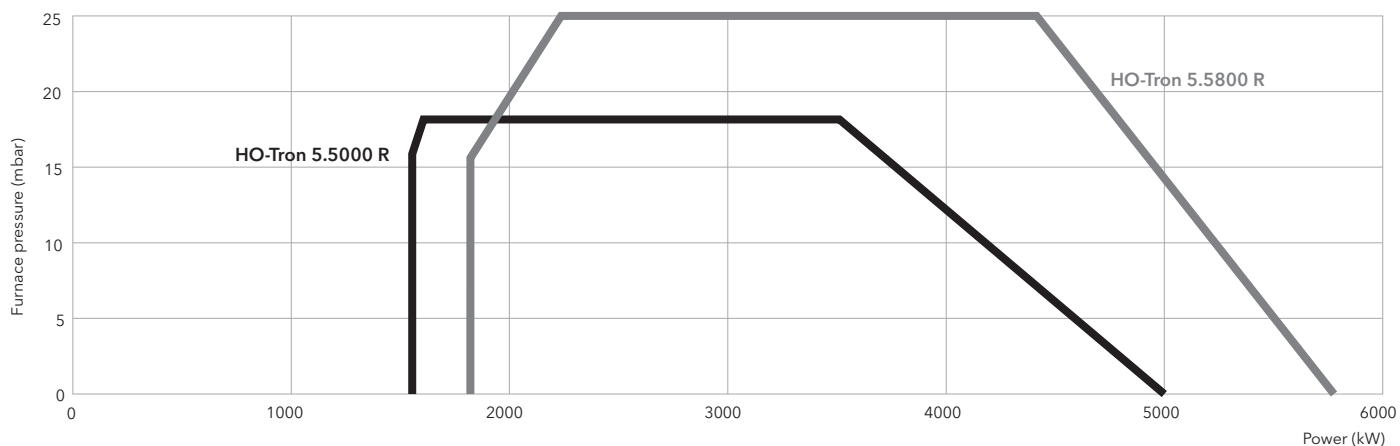

	HO-TRON 5.5000 R		HO-TRON 5.5800 R	
Operating range	1 578 - 5 000 kW		1 795 - 5 800 kW	
Fuel flow	140 - 440 kg/h		159 - 510 kg/h	
Nozzles	according to required power		according to required power	
Control box	LAL 1.25		LAL 1.25	
Fan motor	2 800 rpm - 230/400 V - 50 Hz - 11 kW		2 800 rpm - 230/400 V - 50 Hz - 15 kW	
Pump	TA 4C		TA 4C	
Resistance on pre-heaters	24 kW		24 kW	
Head lenght	KN	KL	KN	KL
Complete burner code	3 143 183	on request	on request	on request



DIMENSIONS (mm)

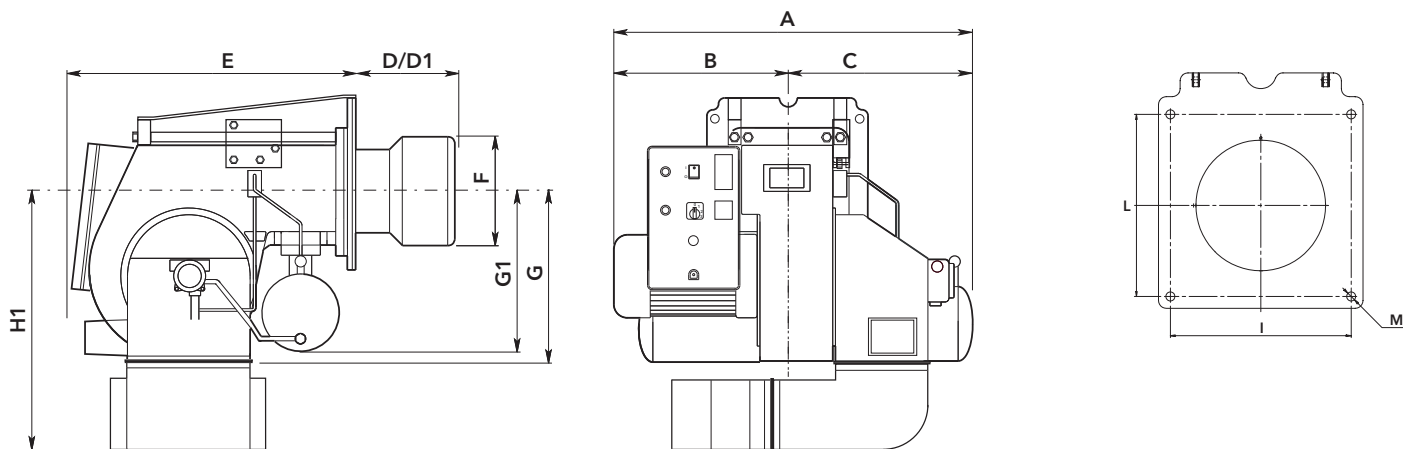

Model	A	B	C	D	D1	E	F	G	G1	H1	I	L	M
HO-TRON 5 R	1300	610	690	370	670	990	320	570	480	965	460	460	M16

PACKAGING

The complete burner with combustion head is delivered in a single carton box with flexible hoses and operating manual including electrical terminal diagram and spare parts list.

Models	Dimensions (mm)		
	X	Y	Z
HO-TRON 5 R	1580	1580	1050

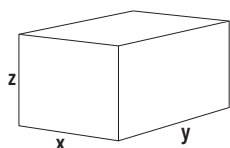

HO-TRON 6 R

2417 ... 12500 kW

2 stage progressive/modulating mechanical

- **Fuel:** heavy oil, viscosity 50°E at 50°C, low calorific value 10,5...11,5 kWh/kg.
- **Emission class:** class 1 (250 mg/kWh) according to EN267
- **Electrical power supply:** three-phase 230/400 V - 50 Hz
- **Protection level:** IP 42 (IP54 on request).

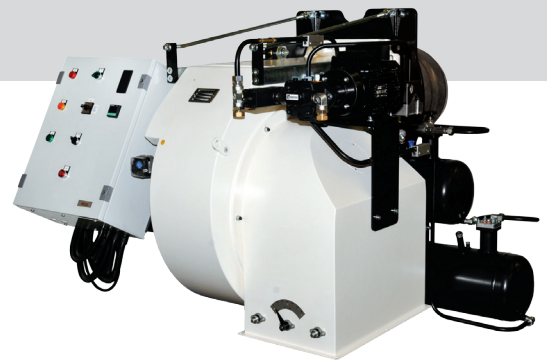

TECHNICAL DATA

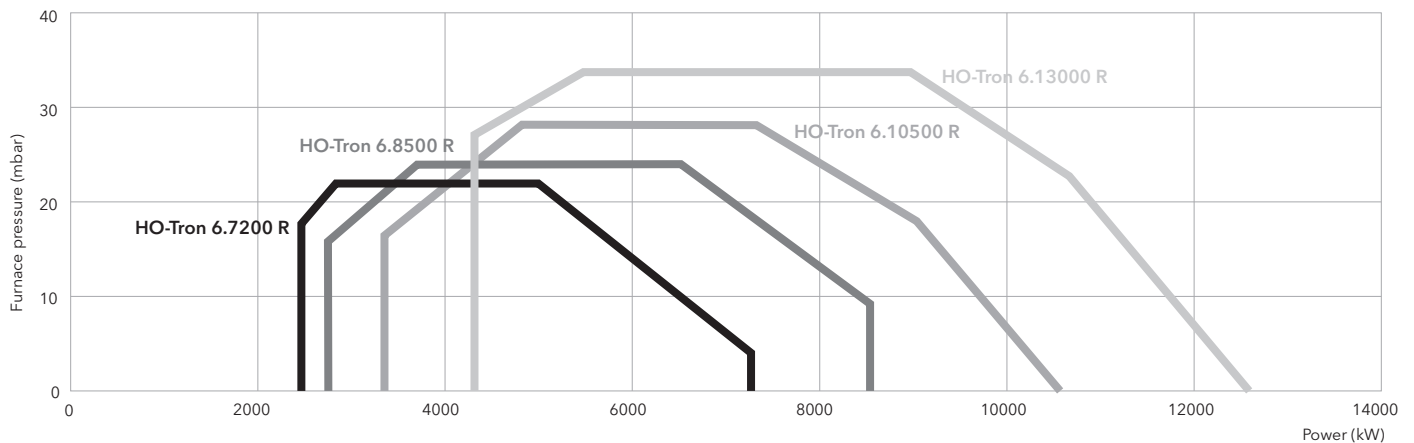

	HO-TRON 6.7200 R		HO-TRON 6.8500 R		HO-TRON 6.10500 R		HO-TRON 6.13000 R	
Operating range	2 417 - 7 500 kW		2 750 - 8 500 kW		3 300 - 10 500 kW		4 367 - 12 500 kW	
Fuel flow	214 - 660 kg/h		243 - 748 kg/h		292 - 924 kg/h		386 - 1 099 kg/h	
Nozzles	according to required power		according to required power		according to required power		according to required power	
Control box	LAL 2.25		LAL 2.25		LAL 2.25		LAL 2.25	
Fan motor	2 800 rpm - 230/400 V 50 Hz - 15 kW		2 800 rpm - 230/400 V 50 Hz - 18,5 kW		2 800 rpm - 230/400 V 50 Hz - 22 kW		2 800 rpm - 230/400 V 50 Hz - 37 kW	
Pump	TA 5C		TA 5C		T5 + TV		T5 + TV	
Resistance on pre-heaters	30 kW		30 kW		44 kW		60 kW	
Head lenght	KN	KL	KN	KL	KN	KL	KN	KL
Complete burner code	on request	on request	3 143 166	on request	on request	on request	3 142 911	on request

DIMENSIONS (mm)

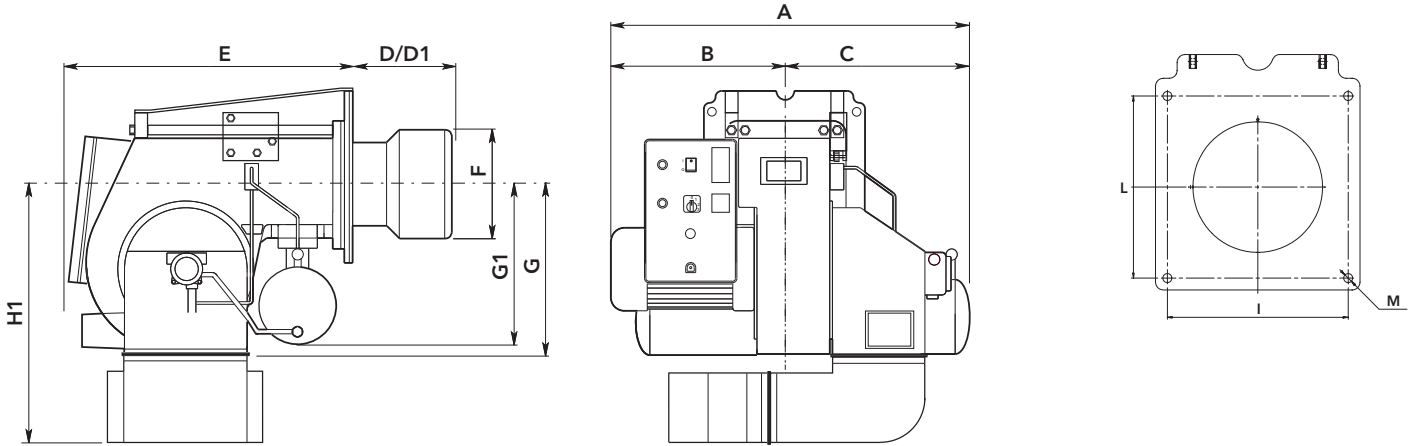

Model	A	B	C	D	D1	E	F	G	G1	H1	I	L	M
HO-TRON 6.7200 R	1390	660	730	525	-	1240	385	775	520	1270	460	460	M20
HO-TRON 6.8500 R	1480	660	820	535	-	1240	430	775	520	1270	460	460	M20
HO-TRON 6.10500 R	1505	685	820	535	-	1240	460	775	520	1270	460	460	M20
HO-TRON 6.13000 R	1750	800	950	535	-	1410	460	775	900	1270	460	460	M20

PACKAGING

The complete burner with combustion head is delivered in a single carton box with flexible hoses and operating manual including electrical terminal diagram and spare parts list.

Models	Dimensions (mm)		
	X	Y	Z
HO-TRON 6 R	2400	1800	1600

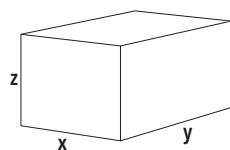

HO-TRON 7 R

5000 ... 17000 kW

2 stage progressive/modulating mechanical

- **Fuel:** heavy oil, viscosity 50°E at 50°C, low calorific value 10,5...11,5 kWh/kg.
- **Emission class:** class 1 (250 mg/kWh) according to EN267
- **Electrical power supply:** three-phase 230/400 V - 50 Hz
- **Protection level:** IP 42 (IP54 on request).

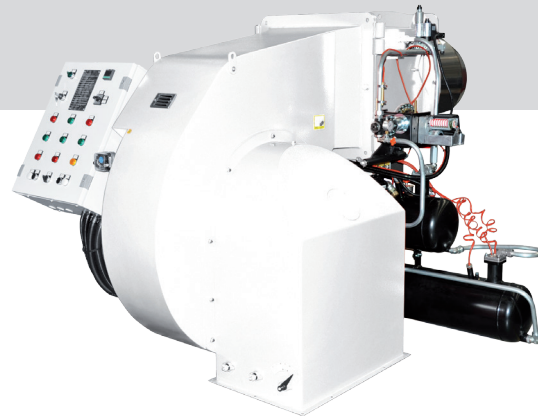

TECHNICAL DATA

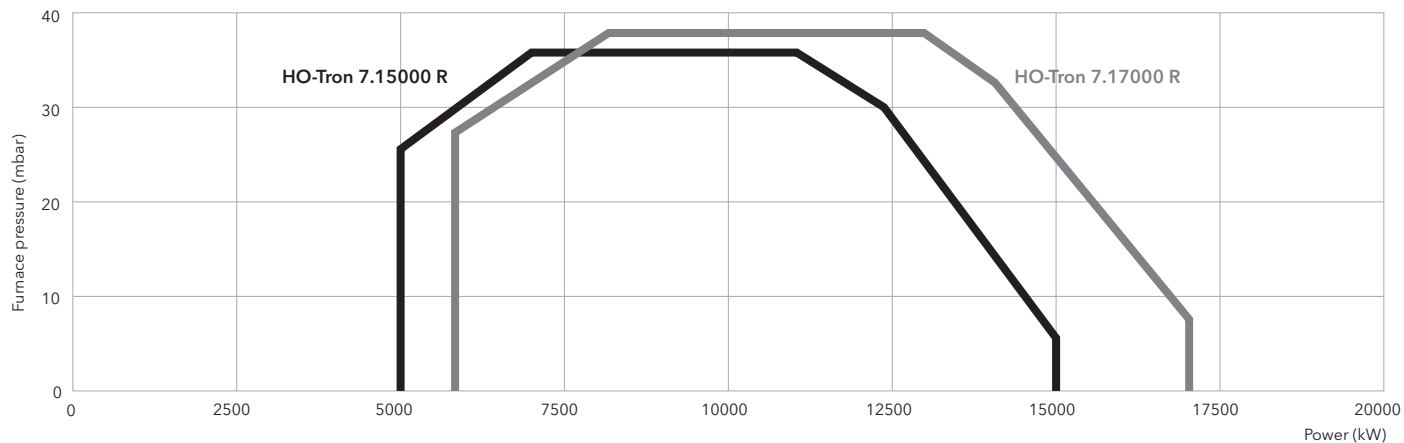

	HO-TRON 7.15000 R		HO-TRON 7.17000 R	
Operating range	5 000 - 15 000 kW		5 700 - 17 000 kW	
Fuel flow	440 - 1 319 kg/h		500 - 1 495 kg/h	
Nozzles	according to required power		according to required power	
Control box	LAL 1.25		LAL 1.25	
Fan motor	2 800 rpm - 230/400 V - 50 Hz - 45 kW		2 800 rpm - 230/400 V - 50 Hz - 55 kW	
Pump	T5 + TV		T5 + TV	
Resistance on pre-heaters	75 kW		75 kW	
Head lenght	KN	KL	KN	KL
Complete burner code	on request	on request	on request	on request



DIMENSIONS (mm)

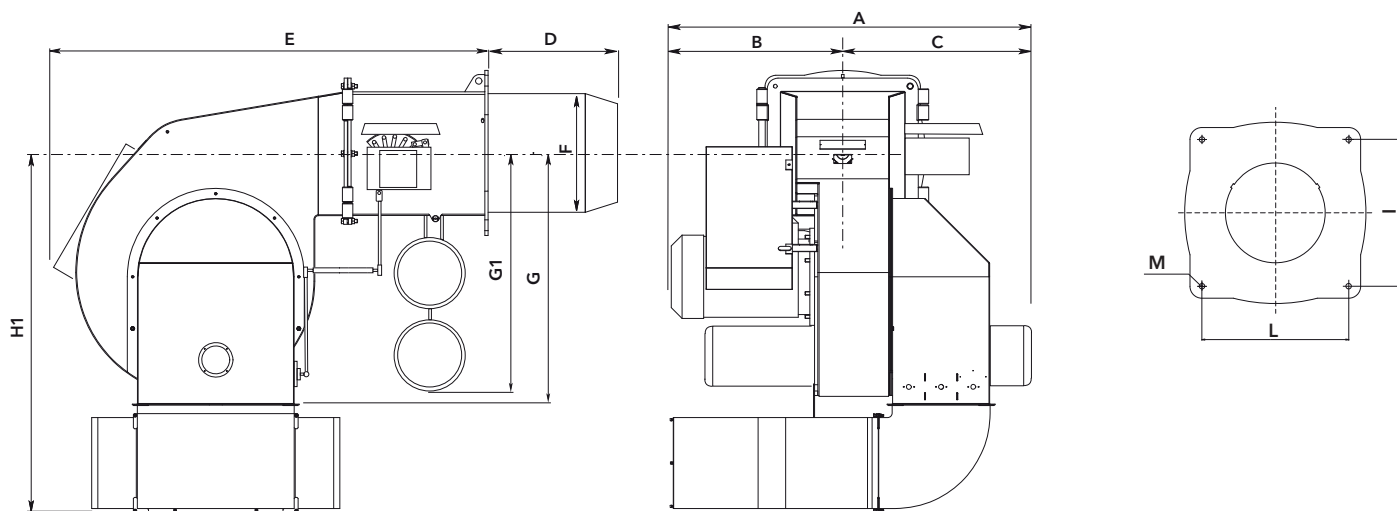

Model	A	B	C	D	E	F	G	G1	H1	I	L	M
HO-TRON 7.15000 R	1700	800	900	590	1910	550	1320	1220	1670	620	620	M20
HO-TRON 7.17000 R	1770	870	900	590	1910	550	1320	1220	1670	620	620	M20

PACKAGING

The complete burner with combustion head is delivered in a single carton box with flexible hoses and operating manual including electrical terminal diagram and spare parts list.

Models	Dimensions (mm)		
	X	Y	Z
HO-TRON 7 R	2800	2100	2000

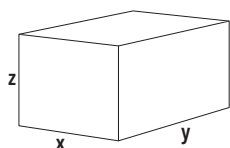

Monoblock burners from 414 to 17000 kW Dual fuel (gas/heavy oil)

GHO-TRON burners are suitable to work with natural gas or heavy oil up to 50°E at 50°C.

This dual fuel range is available in two different configurations:

- two stage version with electric servomotor and integrated system for the regulation of air and fuel for the model GHO-TRON 3
- two stage progressive version with electrical servomotor and double adjustable mechanical cam that allows air and fuel fine tuning (for models up to 17 MW).



GHO-TRON burners feature an adjustable combustion head for easy regulation and matching with different combustion chambers.

All burners are characterized by easy access to the combustion component in order to simplify the maintenance operations.

All the models are fitted with special components for heavy oil combustion.

Models starting from GHO-TRON 3 are equipped with digital thermoregulator integrated on the front panel to grant temperature stability of the fuel. All the burners of the series have an heavy oil electric heating system on board and, startin from GHO-TRON 6, gas pilot included with separate supply line.

Configurated and special version on request for selected type of applications and fuel characteristics.

MAIN TECHNICAL FEATURES

- Two stages and two stage progressive/modulating mechanical forced draught burners
- Electronic version available on request
- Fuels:
 - natural gas, low calorific value 6,99...11,39 kWh/Nm³
 - heavy oil, viscosity 50°E at 50°C, net calorific value 10,97 kWh/kg
- Two combustion head lengths available
- Gun type architecture:
 - separated forced draught fan;
 - optimal accessibility;
 - easy maintenance;
 - secured burner head adjustments;
 - closing of the air flap on burner shut-down
- Separated motor-pump on board
- Electrical heavy oil heater (oil supply to the burner at 80°C and 3 bar)
- Additional heating on the pipes and the valves, into the pump and the nozzle holder
- Closing of the air flap on burner shut-down
- Complete electrical equipment in a switch cabinet mounted on the burner with control panel
- Products are in compliance with EN267 and EN676 European standards and with the following directives:
 - 2014/35/UE Low Voltage Directive
 - 2014/30/UE EMC Directive
 - 2009/142/CEE Gas Appliances Directive
 - 2006/42/EC Machinery Directive
 - 2011/65/EU RoHS2 Directive

RANGE OVERVIEW

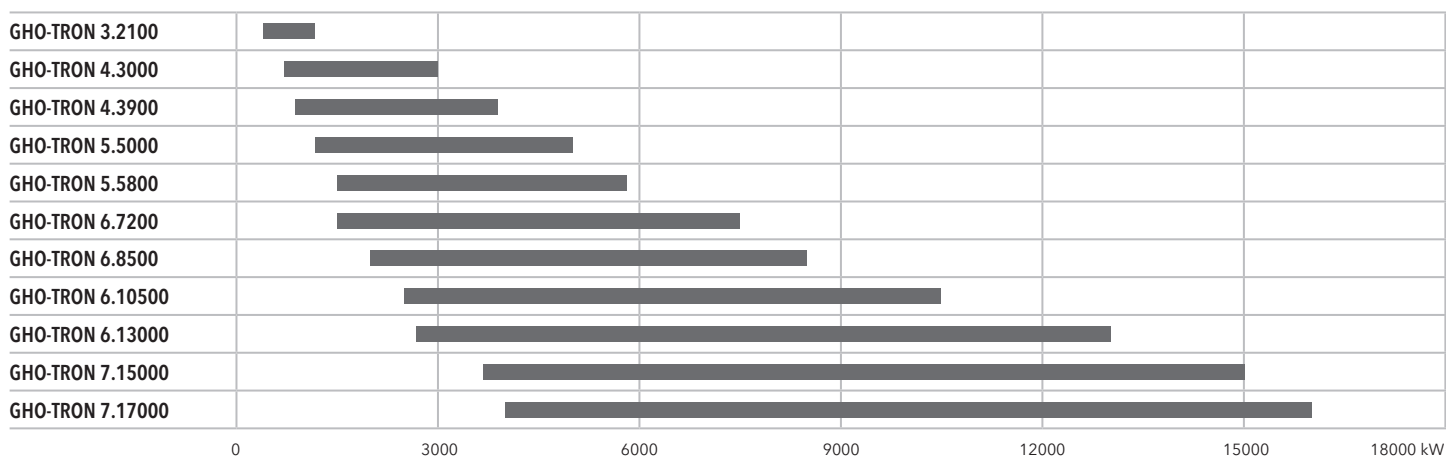

GHO-TRON 3 Z

414 ... 2150 kW
2 stages

- **Fuels:** natural gas, low calorific value 6,99 ... 11,39 kWh/m³; heavy oil, viscosity 50°E at 50°C, low calorific value 10,5...11,5 kWh/kg.
- **Emission class:** Low NOx class 2 (<120 mg/kWh) according to EN676 in gas; class 1 (250 mg/kWh) according to EN267 in light oil
- **Electrical power supply:** three-phase 230/400 V - 50 Hz
- **Protection level:** IP 42 (IP54 on request).

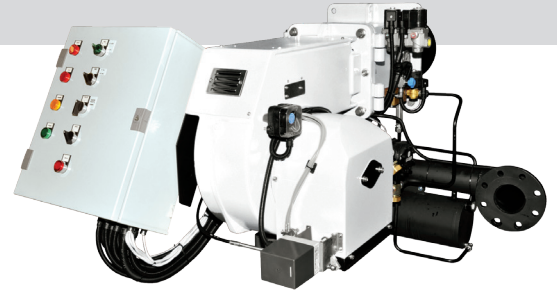

TECHNICAL DATA

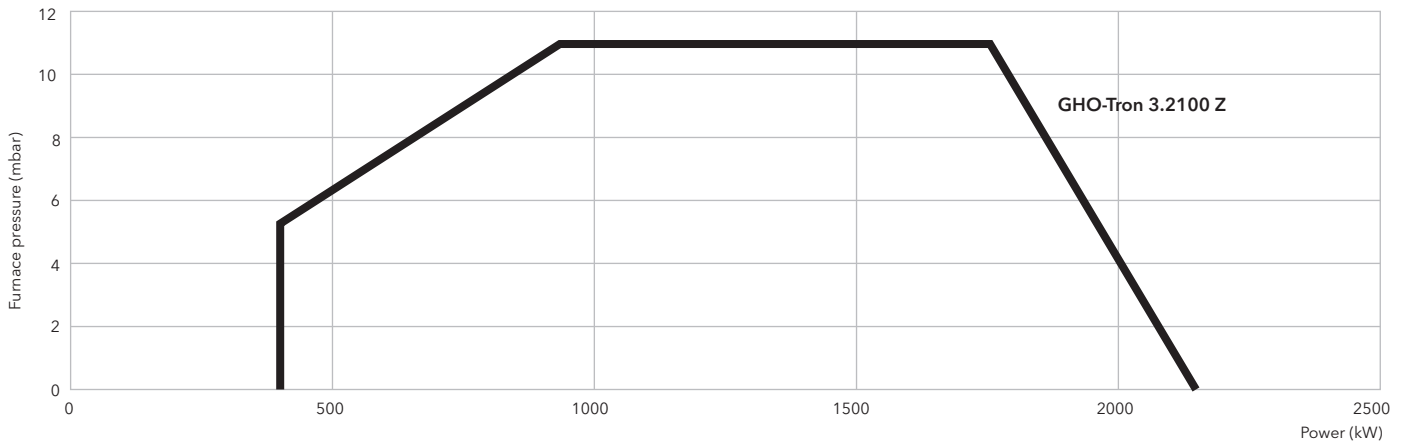

GHO-TRON 3.2100 Z	
Operating range	414 - 2 150 kW
Fuel flow	36 - 189 kg/h
Nozzles	according to required power
Control box	LGB 22
Fan motor	2 800 rpm - 230/400 V - 50 Hz - 4 kW
Pump	E7 NC
Resistance on pre-heaters	10,5 kW
Head lenght	KN KL
Complete burner code	on request on request

i Dimensions of gas trains and gas filters: see pag. 203

DIMENSIONS (mm)

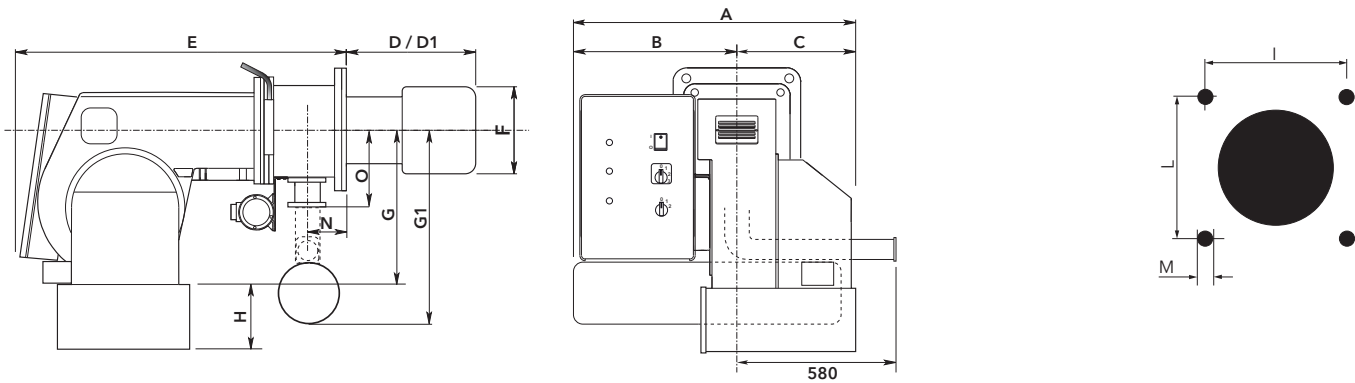

Model	A	B	C	D	D1	E	F	G	G1	H	N	O	I	L	M
GHO-TRON 3 Z	848	530	318	295	455	1150	270	395	600	283	125	250	315	315	M16

PACKAGING

The complete burner with combustion head is delivered in a single carton box with flexible hoses and operating manual including electrical terminal diagram and spare parts list.

Models	Dimensions (mm)		
	X	Y	Z
GHO-TRON 3 Z	1370	1140	950

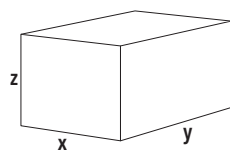

GHO-TRON 4 R

650 ... 3900 kW

2 stage progressive/modulating mechanical

- **Fuels:** natural gas, low calorific value 6,99 ... 11,39 kWh/m³; heavy oil, viscosity 50°E at 50°C, low calorific value 10,5...11,5 kWh/kg.
- **Emission class:** Low NO_x class 2 (<120 mg/kWh) according to EN676 in gas; class 1 (250 mg/kWh) according to EN267 in light oil
- **Electrical power supply:** three-phase 230/400 V - 50 Hz
- **Protection level:** IP 42 (IP54 on request).



TECHNICAL DATA

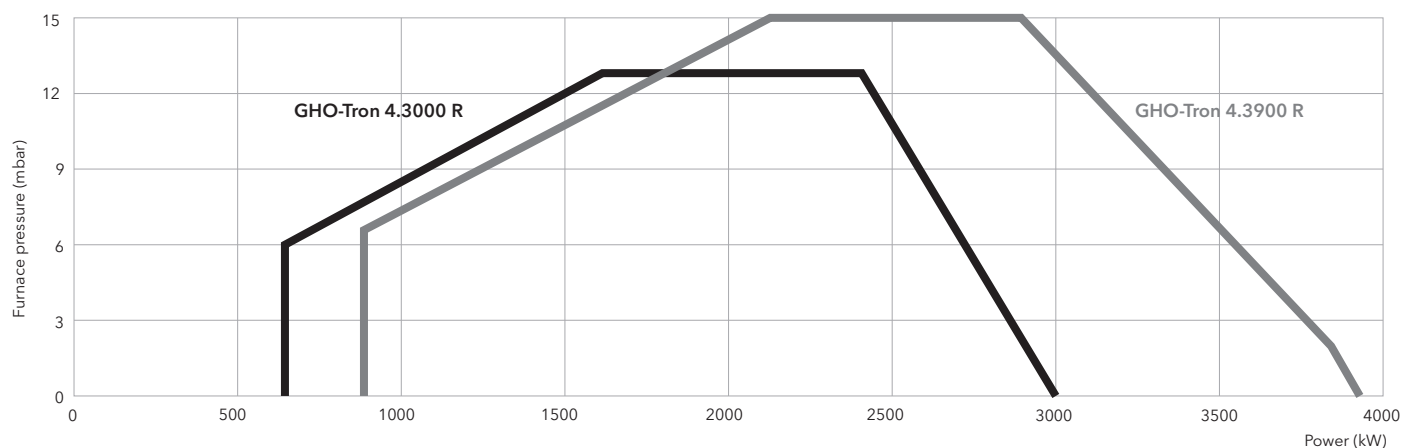

	GHO-TRON 4.3000 R		GHO-TRON 4.3900 R	
Operating range	650 - 3 000 kW		875 - 3 900 kW	
Fuel flow	57 - 264 kg/h		77 - 343 kg/h	
Nozzles	according to required power		according to required power	
Control box	LFL 1.333		LFL 1.333	
Fan motor	2 800 rpm - 230/400 V - 50 Hz - 7,5 kW		2 800 rpm - 230/400 V - 50 Hz - 9 kW	
Pump	TA 3C		TA 3C	
Resistance on pre-heaters	18 kW		21 kW	
Head lenght	KN	KL	KN	KL
Complete burner code	on request	on request	on request	on request

 Dimensions of gas trains and gas filters: see pag. 203

DIMENSIONS (mm)

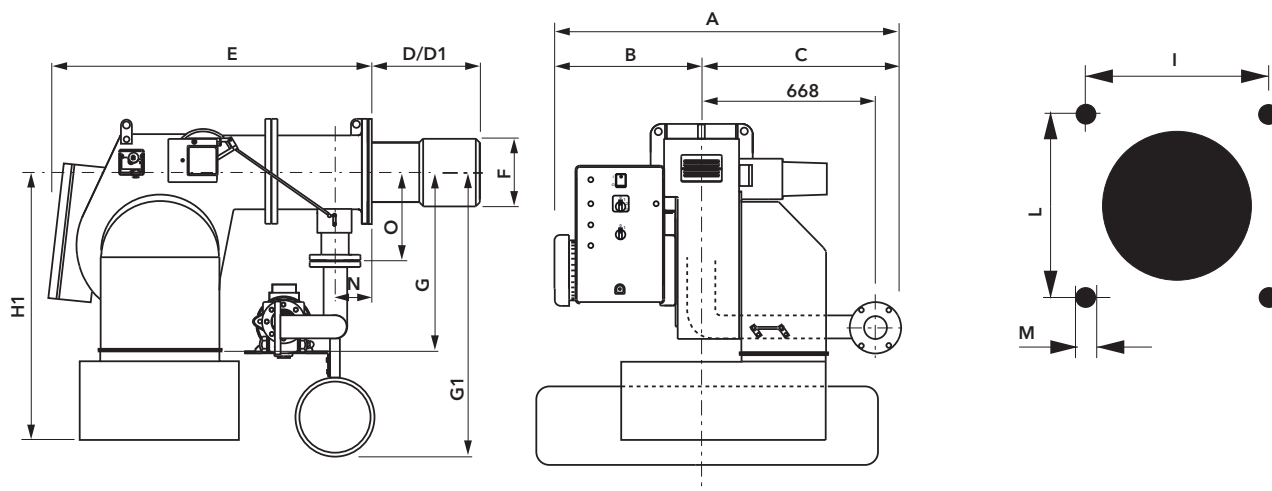

Model	A	B	C	D	D1	E	F	G	G1	H1	N	O	I	L	M
GHO-TRON 4.3000 R	1288	610	678	330	530	1130	290	471	750	280	195	250	315	315	M16
GHO-TRON 4.3900 R	1288	610	678	345	545	1130	320	471	750	280	195	250	315	315	M16

PACKAGING

The complete burner with combustion head is delivered in a single carton box with flexible hoses and operating manual including electrical terminal diagram and spare parts list.

Models	Dimensions (mm)		
	X	Y	Z
GHO-TRON 4 R	1580	1580	1050

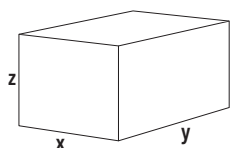

GHO-TRON 5 R

1200 ... 5800 kW

2 stage progressive/modulating mechanical

- **Fuels:** natural gas, low calorific value 6,99 ... 11,39 kWh/m³; heavy oil, viscosity 50°E at 50°C, low calorific value 10,5...11,5 kWh/kg.
- **Emission class:** Low NOx class 2 (<120 mg/kWh) according to EN676 in gas; class 1 (250 mg/kWh) according to EN267 in light oil
- **Electrical power supply:** three-phase 230/400 V - 50 Hz
- **Protection level:** IP 42 (IP54 on request).



TECHNICAL DATA

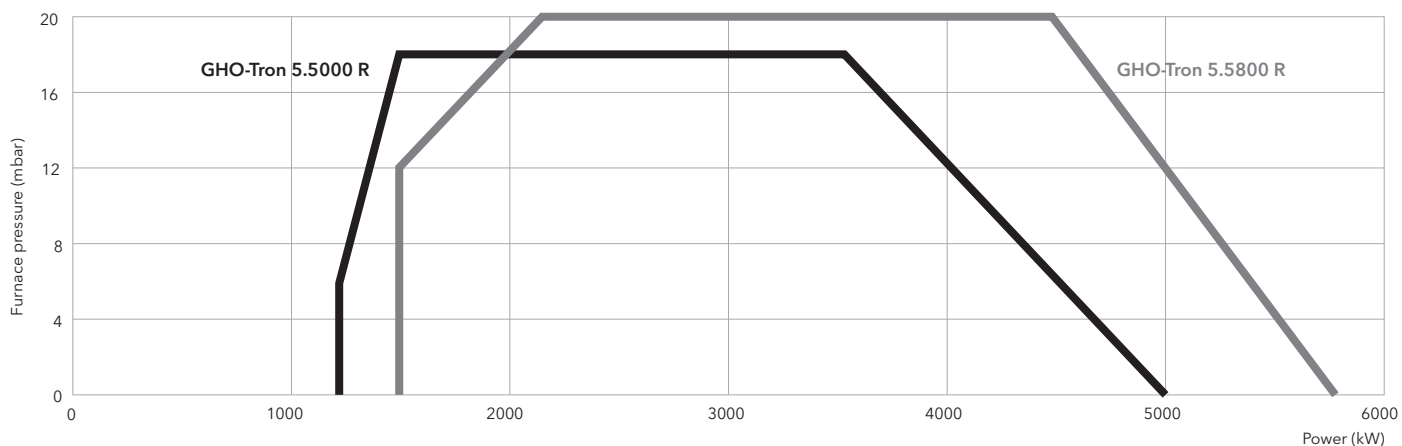

	GHO-TRON 5.5000 R		GHO-TRON 5.5800 R	
Operating range	1 200 - 5 000 kW		1 500 - 5 800 kW	
Fuel flow	106 - 440 kg/h		132 - 510 kg/h	
Nozzles	according to required power		according to required power	
Control box	LFL 1.333		LFL 1.333	
Fan motor	2 800 rpm - 230/400 V - 50 Hz - 11 kW		2 800 rpm - 230/400 V - 50 Hz - 15 kW	
Pump	TA 4C		TA 4C	
Resistance on pre-heaters	24 kW		24 kW	
Head lenght	KN	KL	KN	KL
Complete burner code	on request	on request	on request	on request

i Dimensions of gas trains and gas filters: see pag. 203

DIMENSIONS (mm)

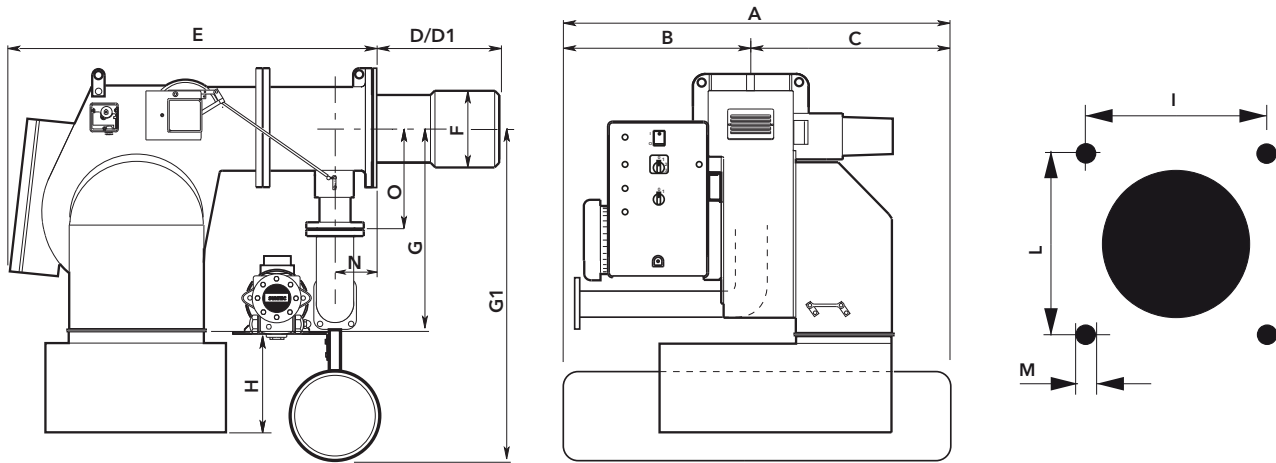

Model	A	B	C	D	D1	E	F	G	G1	H1	N	O	I	L	M
GHO-TRON 5 R	1358	680	678	354	554	1230	320	570	775	965	195	250	330	330	M16

PACKAGING

The complete burner with combustion head is delivered in a single carton box with flexible hoses and operating manual including electrical terminal diagram and spare parts list.

Models	Dimensions (mm)		
	X	Y	Z
GHO-TRON 5 R	1580	1580	1050

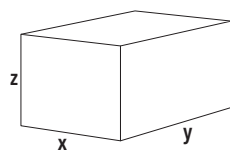

GHO-TRON 6 R

1500 ... 13000 kW

2 stage progressive/modulating mechanical

- **Fuels:** natural gas, low calorific value 6,99 ... 11,39 kWh/m³; heavy oil, viscosity 50°E at 50°C, low calorific value 10,5...11,5 kWh/kg.
- **Emission class:** Low NO_x class 2 (<120 mg/kWh) according to EN676 in gas; class 1 (250 mg/kWh) according to EN267 in light oil
- **Electrical power supply:** three-phase 230/400 V - 50 Hz
- **Protection level:** IP 42 (IP54 on request).

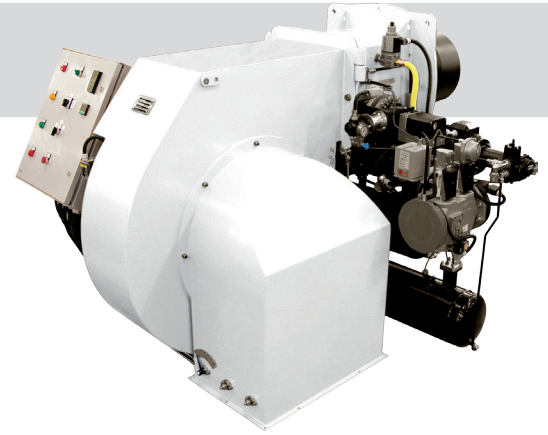

TECHNICAL DATA

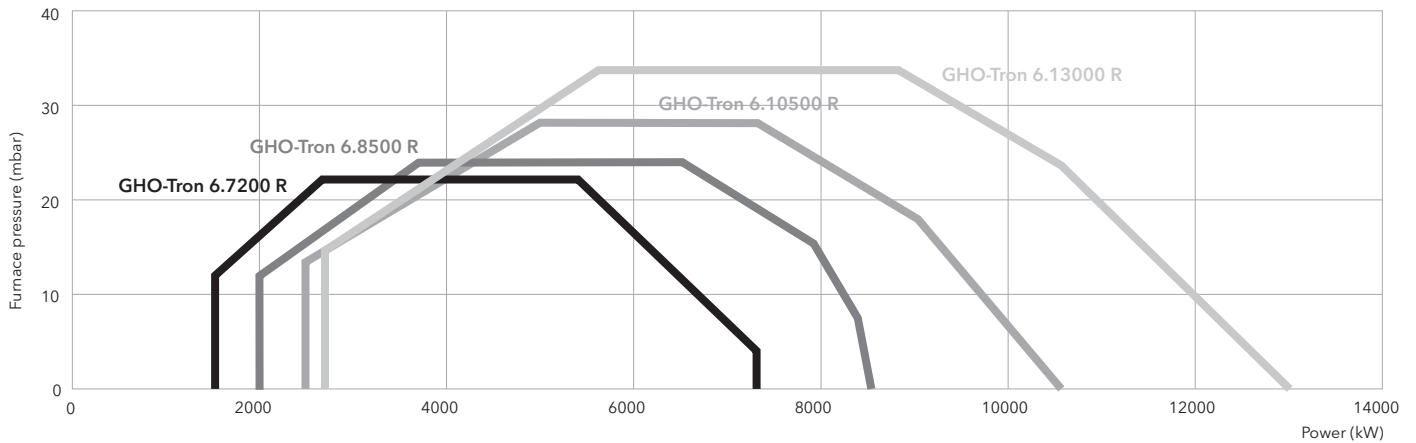

	GHO-TRON 6.7200 R		GHO-TRON 6.8500 R		GHO-TRON 6.10500 R		GHO-TRON 6.13000 R	
Operating range	1 500 - 7 500 kW		2 000 - 8 500 kW		2 500 - 10 500 kW		2 700 - 13 000 kW	
Fuel flow	132 - 660 kg/h		176 - 750 kg/h		220 - 920 kg/h		240 - 1 100 kg/h	
Nozzles	according to required power		according to required power		according to required power		according to required power	
Control box	LFL 1.333		LFL 1.333		LFL 1.333		LFL 1.333	
Fan motor	2 800 rpm - 230/400 V 50 Hz - 15 kW		2 800 rpm - 230/400 V 50 Hz - 18,5 kW		2 800 rpm - 230/400 V 50 Hz - 22 kW		2 800 rpm - 230/400 V 50 Hz - 37 kW	
Pump	TA 5C		TA 5C		T5 + TV		T5 + TV	
Resistance on pre-heaters	30 kW		30 kW		44 kW		60 kW	
Head lenght	KN	KL	KN	KL	KN	KL	KN	KL
Complete burner code	on request	on request	on request	on request	on request	on request	on request	on request

 **Dimensions of gas trains and gas filters:** see pag. 203

DIMENSIONS (mm)

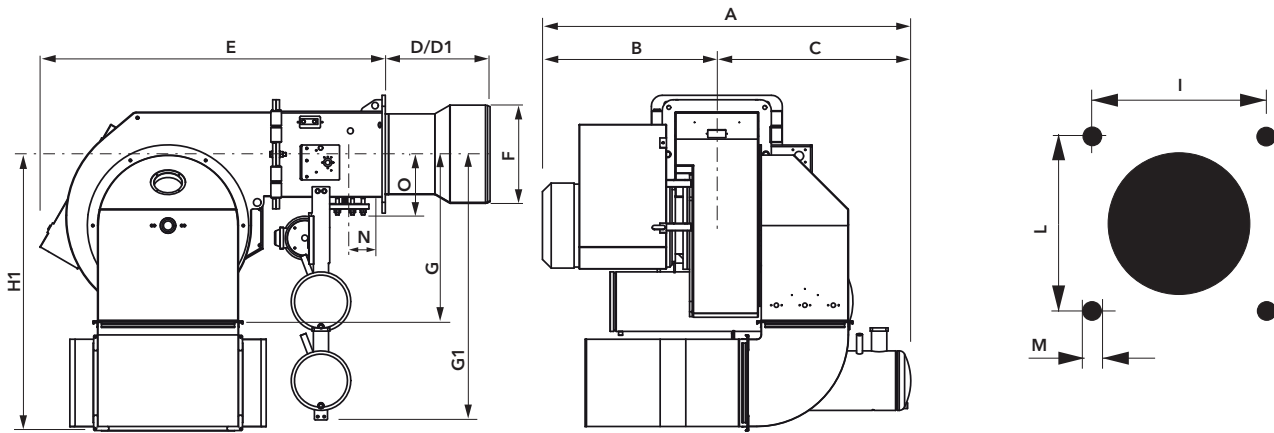

Model	A	B	C	D	D1	E	F	G	G1	H1	N	O	I	L	M
GHO-TRON 6.7200 R	1370	740	630	470	-	1640	420	775	850	1270	195	232	460	460	M20
GHO-TRON 6.8500 R	1370	740	630	470	-	1640	420	775	850	1270	195	232	460	460	M20
GHO-TRON 6.10500 R	1500	740	760	470	-	1640	420	775	850	1270	195	232	460	460	M20
GHO-TRON 6.13000 R	1700	800	900	470	-	1640	450	775	1200	1270	195	232	460	460	M20

PACKAGING

The complete burner with combustion head is delivered in a single carton box with flexible hoses and operating manual including electrical terminal diagram and spare parts list.

Models	Dimensions (mm)		
	X	Y	Z
GHO-TRON 6 R	2400	1800	1600

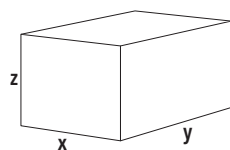

GHO-TRON 7 R

3700 ... 17000 kW

2 stage progressive/modulating mechanical

- **Fuels:** natural gas, low calorific value 6,99 ... 11,39 kWh/m³; heavy oil, viscosity 50°E at 50°C, low calorific value 10,5...11,5 kWh/kg.
- **Emission class:** Low NOx class 2 (<120 mg/kWh) according to EN676 in gas; class 1 (250 mg/kWh) according to EN267 in light oil
- **Electrical power supply:** three-phase 230/400 V - 50 Hz
- **Protection level:** IP 42 (IP54 on request).

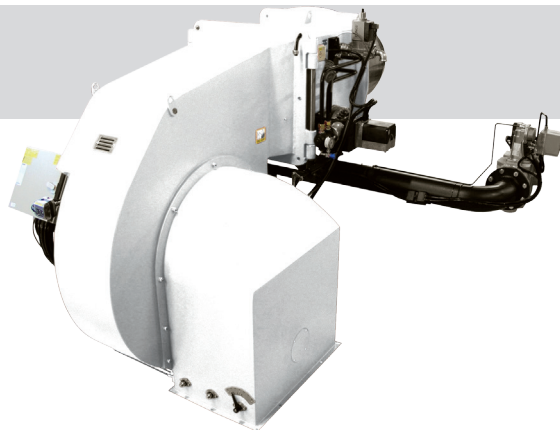

TECHNICAL DATA

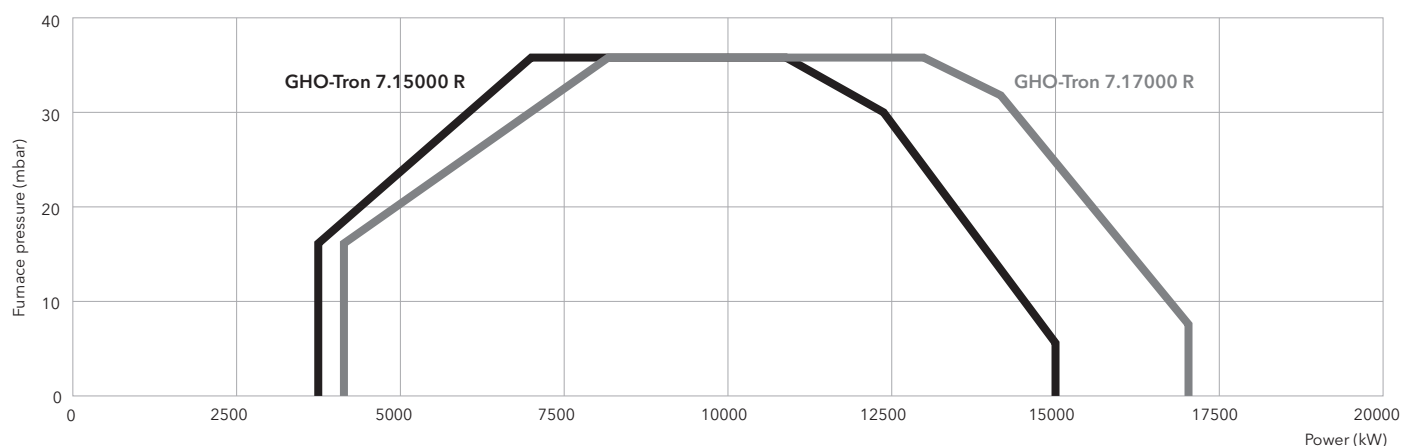

	GHO-TRON 7.15000 R		GHO-TRON 7.17000 R	
Operating range	3 690 - 15 000 kW		4 000 - 17 000 kW	
Fuel flow	325 - 1 320 kg/h		350 - 1 495 kg/h	
Nozzles	according to required power		according to required power	
Control box	LFL 1.333		LFL 1.333	
Fan motor	2 800 rpm - 230/400 V - 50 Hz - 45 kW		2 800 rpm - 230/400 V - 50 Hz - 55 kW	
Pump	T5 + TV		T5 + TV	
Resistance on pre-heaters	75 kW		75 kW	
Head lenght	KN	KL	KN	KL
Complete burner code	on request	on request	on request	on request

 Dimensions of gas trains and gas filters: see pag. 203

DIMENSIONS (mm)

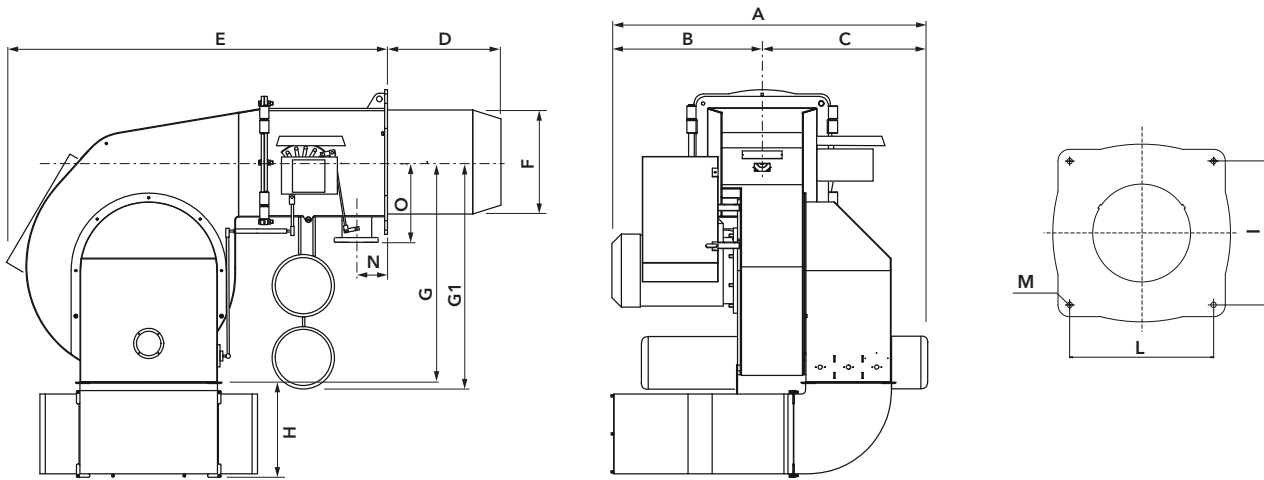

Model	A	B	C	D	E	F	G	G1	H1	N	O	I	L	L	M
GHO-TRON 7 R	1948	860	1088	590	1910	550	1167	1220	530	210	320	620	620	M20	M20

PACKAGING

The complete burner with combustion head is delivered in a single carton box with flexible hoses and operating manual including electrical terminal diagram and spare parts list.

Models	Dimensions (mm)		
	X	Y	Z
GHO-TRON 7 R	2800	2100	2000

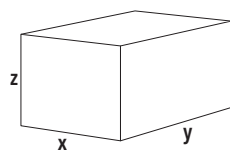

Duoblock burners from 230 to 80000 kW Gas, light oil, heavy oil and dual fuel operation

All the benefits of the separate ventilation

In contrast to monoblock burners, duoblock burners are made up of two units, or blocks, as the name implies: the burner head with the air inlet, and the separately-installed fan; the two units are connected via an air duct.

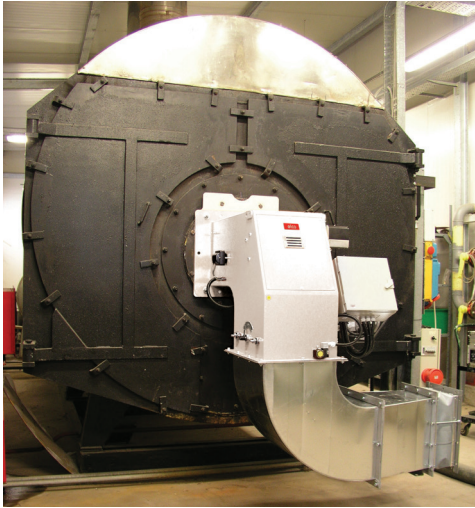

The separate installation of the fan offers several benefits:

- the fan can be installed in a separate room, for instance in the cellar; this results in considerably lower noise levels in the boiler room; when the fan is installed in the same room, a fan enclosure can be used to achieve optimum sound absorption, without inhibiting access to the burner;
- less space required in front of the boiler and in the combustion chamber;
- individual fan layout with optimum adaptation of the fan characteristic curve to suit the pressure ratio of the heat generator; this guarantees pulsation-free and stable burner behaviour, even on heat generators with high resistance on the exhaust side;
- combustion air can be pre-heated to increase installation efficiency;
- lower weight loading on the boiler front.

ELCO duoblock burners are designed to satisfy the widest range of needs and can be applied to the most various type of civil and industrial solutions like fire-tube boilers, water-tube boilers, dryers and melting furnaces.

These burners enable installation to realize a modular and flexible combustion solution with a high degree of personalization. This results in a high performance installations at the lowest running cost.

The burners are built to be connected to an external air supply and can be supplied together with built-in or separate control panel, electronic or mechanical adjustment, flue gas recirculation, heavy oil pump unit and heating unit.

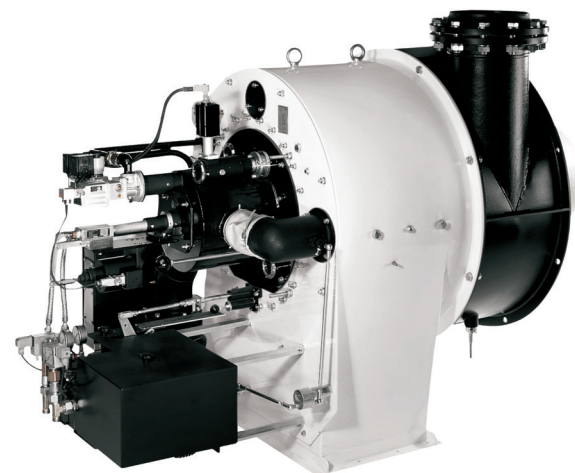
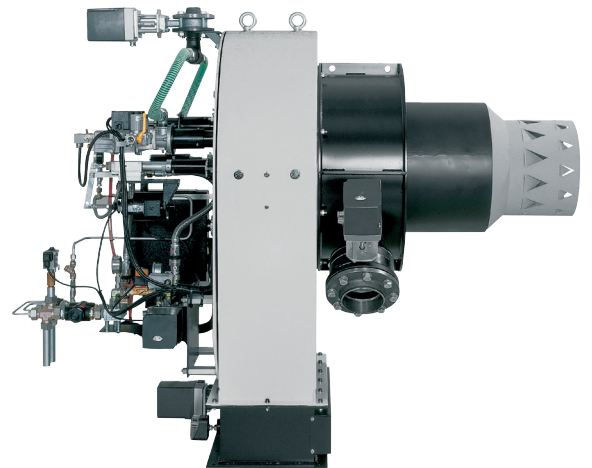

ELCO is able to offer an extremely wide range of industrial duoblock burners thanks to three different series, EK-DUO, RPD and D-TRON, covering a power range from 230 kW up to 80 MW.

This range of burners is able to fulfill high capacity and high turndown needs and allows installation in very high pressurized combustion chambers.

All duoblock models can work with pre-heated combustion air up to 200°C and can be used in order to achieve greater values of efficiency.

D-TRON

MAIN TECHNICAL FEATURES

- Two stage progressive/modulating forced draught burner, designed to be connected to an external air supply
- Fuels:
 - natural gas, low calorific value 6,99...11,39 kWh/Nm³
 - light oil, viscosity 6 mm²/s at 20°C, low calorific value 11,86 kWh/kg
 - heavy oil, viscosity 20...350 mm²/s at 50°C, net calorific value 10,97 kWh/kg;
 - other fuels on request;
- Electrical switch cabinet manufactured in different configurations assembled on the burner or delivered separately and includes the burner control:
 - control box for burner operation sequences;
 - contactors and remote overload cut-out for control of the fan unit;
 - fuse to protect the auxiliary equipment;
 - switches, warning and information lights, manual power control;
 - ready to accept PID power regulator (option)
- Gas train factory assembled and tested for tightness and electrical security
- Electronic version available on request
- Products are in compliance with EN 267 and EN 676 European standards

EK-DUO

MAIN TECHNICAL FEATURES

- Two stage progressive/modulating forced draught burners, designed to be connected to an external air supply
- Fuels:
 - natural gas, low calorific value 6,99...11,39 kWh/Nm³
 - light oil, viscosity 6 mm²/s at 20°C, low calorific value 11,86 kWh/kg
 - other fuels on request
- Flame tube length according to installation
- Secured burner head adjustments during maintenance
- Closing of the air damper on burner shutdown
- Control box: built-in or external according to customer requirements
- Gas train factory assembled and tested for tightness and electrical security
- Products are in compliance with EN 267 and EN 676 European standards

RPD

MAIN TECHNICAL FEATURES

- Two stage progressive/modulating forced draught burner with register, designed to be connected to an external air supply
- Fuels:
 - natural gas, low calorific value 6,99...11,39 kWh/Nm³
 - light oil, viscosity 6 mm²/s at 20°C, low calorific value 11,86 kWh/kg
 - heavy oil, viscosity 20...350 mm²/s at 50°C, net calorific value 10,97 kWh/kg;
 - other fuels on request;
 - co-combustion of various fuels or to eliminate liquid waste on request
- Air/gas ratio with Etamatic digital control box or with mechanical compound
- Adjustable flame length with air registers
- Flame tube length according to installation
- Closing of the air damper on burner shutdown
- Control box: built-in or external according to customer requirements
- Gas train factory assembled and tested for tightness and electrical security
- Products are in compliance with EN267 and EN676 European standards

DUOBLOCK RANGE

D-TRON

230 ... 34000 kW

2 stage progressive/modulating mechanical or electronic

- **Fuels:** - natural gas, low calorific value 6,99...11,39 kWh/Nm³
- light oil, viscosity 6 mm²/s at 20°C, low calorific value 11,86 kWh/kg
- heavy oil, viscosity 20...350 mm²/s at 50°C, net calorific value 10,97 kWh/kg;
- other fuels on request;
- **Emission class:** - Low NOx class 2 (<120 mg/kWh) and class 3 (<80 mg/kWh) according to EN676 in gas
- Low NOx class 1 (<250 mg/kWh) or class 2 (<120 mg/kWh) according to EN267 in oil
- **Protection level:** IP 41 (IP 54 and IP 65 on request)



RANGE OVERVIEW

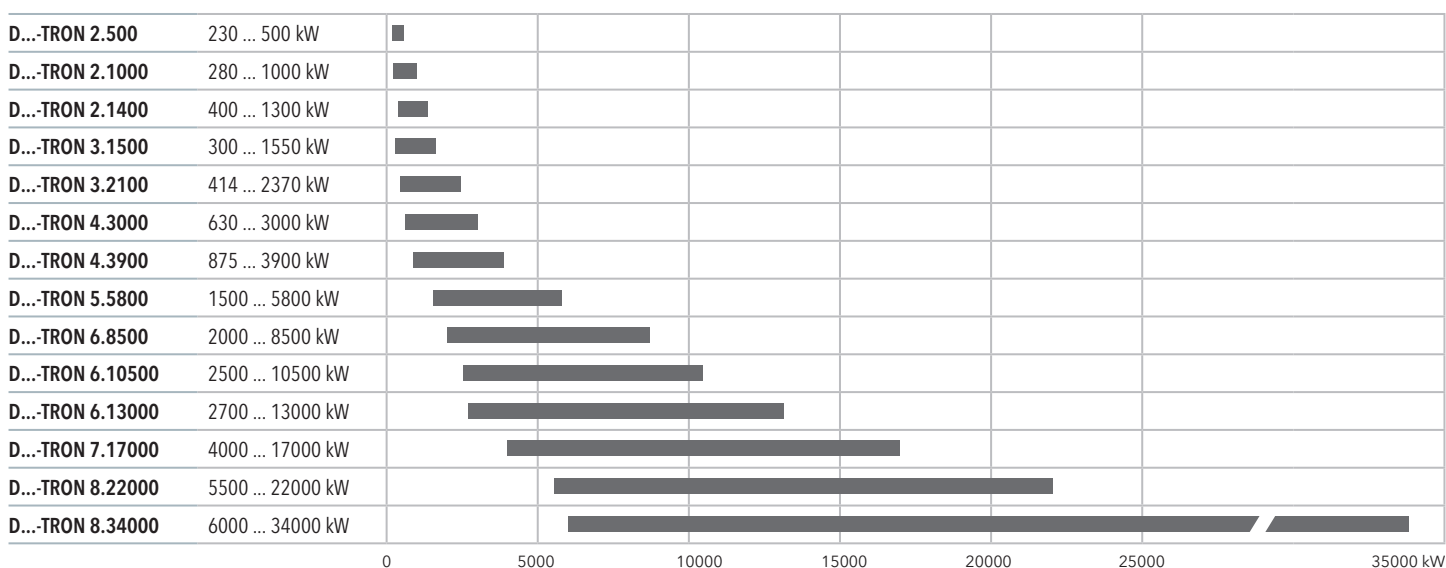

AVAILABLE CONFIGURATIONS

Model	Max Output (kW) (air at 20°C)					Operation		
	Gas DG-TRON	Gas/light oil DGL-TRON	Light oil DL-TRON	Heavy oil DO-TRON	Gas/heavy oil DGO-TRON	2 stages	Mechanical	Electronic
D...-TRON 2.500	○					●	●	
D...-TRON 2.1000	●	●				●	●	●
D...-TRON 2.1400		●				●		
D...-TRON 3.1500	○						●	
D...-TRON 3.2100	●	●	●	●		●	●	●
D...-TRON 4.3000	●	●	●	●	●		●	●
D...-TRON 4.3900	●	●	●	●	●		●	●
D...-TRON 5.5800	●	●	●	●	●		●	●
D...-TRON 6.8500	●	●	●	●	●		●	●
D...-TRON 6.10500	●	●	●	●	●		●	●
D...-TRON 6.13000	●	●	●	●	●		●	●
D...-TRON 7.17000	●	●	●	●	●		●	●
D...-TRON 8.22000	●	●	●	●	●		●	●
D...-TRON 8.34000	●	●	●	●	●		●	●

○ Low NOx class 2

● Low NOx class 3

DIMENSIONS (mm)

D...-TRON 2

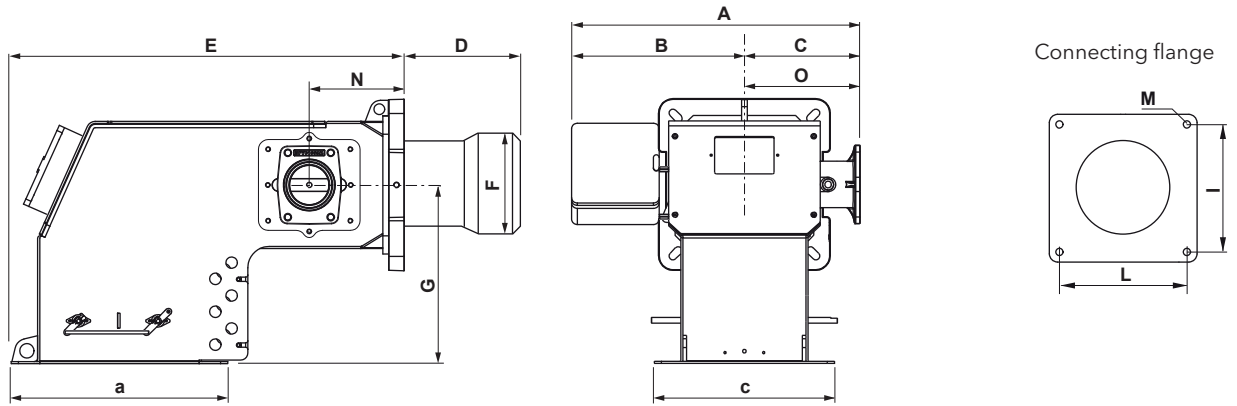

D...-TRON 3...8

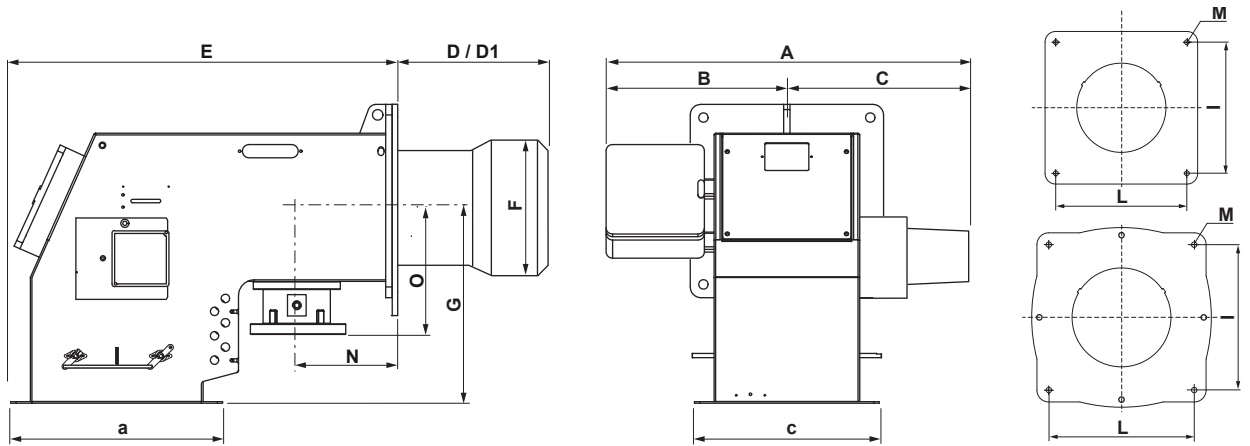

Air duct

D...-TRON 2-3

D...-TRON 4-5

D...-TRON 6

D...-TRON 7

D...-TRON 8

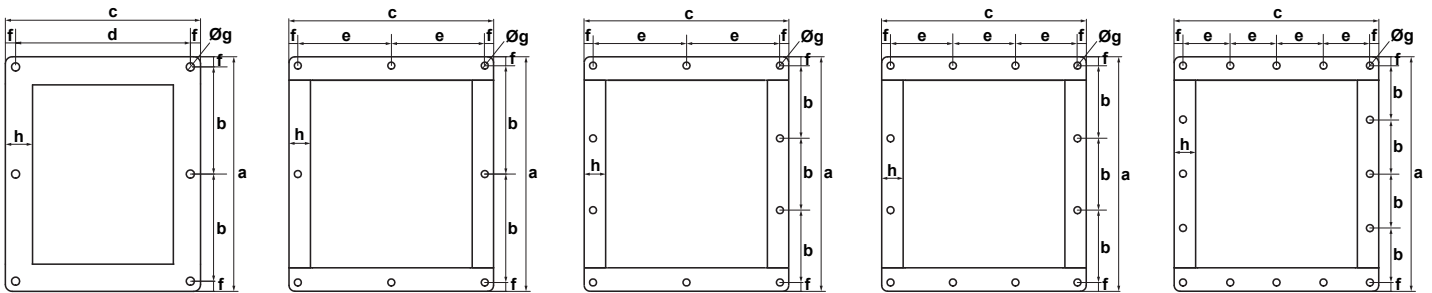

	A	B	C	D	D1	E	F	G	I	L	M	N	O	a	b	c	d	e	f	Øg	h
D...-TRON 2	619	454	165	175	395	560	190	250	190	190	4xM10	140	165	303	136,5	252	222	-	15	6xR12	40
D...-TRON 3	922	444	478	345	545	710	270	375	270	270	4xM16	125	250	345	157,5	287	257	-	15	6xR12	40
D...-TRON 4	971	479	492	345	545	850	320	392	315	315	4xM16	190	250	400	185	349	-	159,5	15	8xR12	40
D...-TRON 5	978	485	493	375	575	810	320	404	330	330	4xM16	195	250	470	220	361	-	165,5	15	8xR12	40
D...-TRON 6	1170	540	630	470	-	1030	420	550	460	460	4xM20	195	232	557	173	474	-	218	19	10xR14	43
D...-TRON 7	1270	630	640	590	-	1480	550	670	620	620	8xM20	210	320	730	230,7	650	-	204	19	12xR14	43
D...-TRON 8	1530	800	730	510	-	1560	720	760	800	800	8xM20	220	412	930	223	828	-	197,5	19	16xR14	40

DUOBLOCK RANGE

EK-DUO

600 ... 16000 kW

2 stage progressive/modulating electronic

- **Fuels:** - natural gas, low calorific value 6,99...11,39 kWh/Nm³
- light oil, viscosity 6 mm²/s at 20°C, low calorific value 11,86 kWh/kg
- other fuels on request
- **Emission class:** - Low NOx class 3 (<80 mg/kWh) according to EN676 in gas and
- Low NOx class 3 (<120 mg/kWh) according to EN267 in light oil
- **Modulating ratio:** 1/3 for light, 1/6 for gas and 1/8 for gas with frequency converter
- **Protection level:** IP 41 (IP 54 and IP 65 on request)

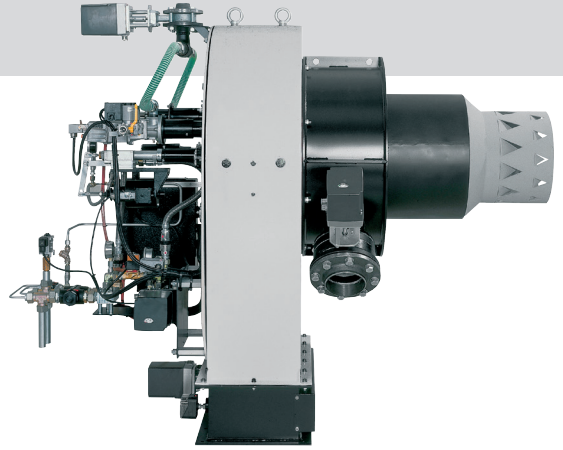

RANGE OVERVIEW

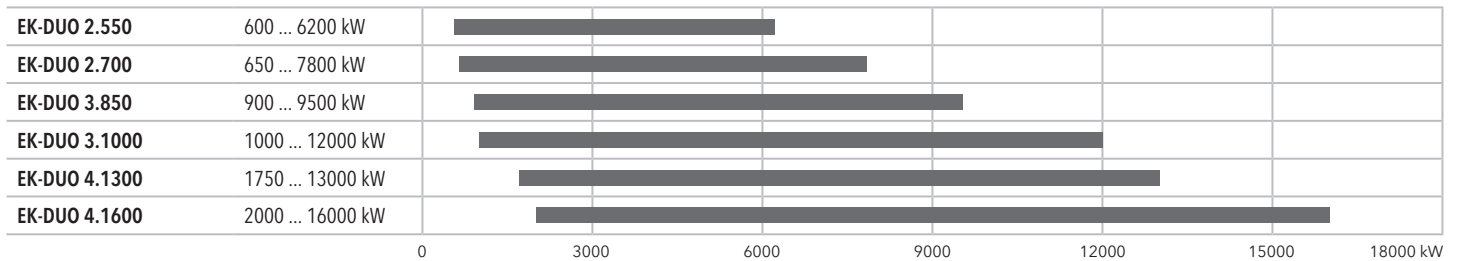

AVAILABLE CONFIGURATIONS

Model	Max output (kW) (air at 20°C)					Operation	
	Gas	Gas/Light oil	Light oil	Heavy oil	Gas/Heavy oil	Mechanical	Electronic
EK-DUO 2.550	•	•	•				•
EK-DUO 2.700	•	•	•				•
EK-DUO 3.850	•	•	•				•
EK-DUO 3.1000	•	•	•				•
EK-DUO 4.1300	•	•	•				•
EK-DUO 4.1600	•	•	•				•

DIMENSIONS (mm)

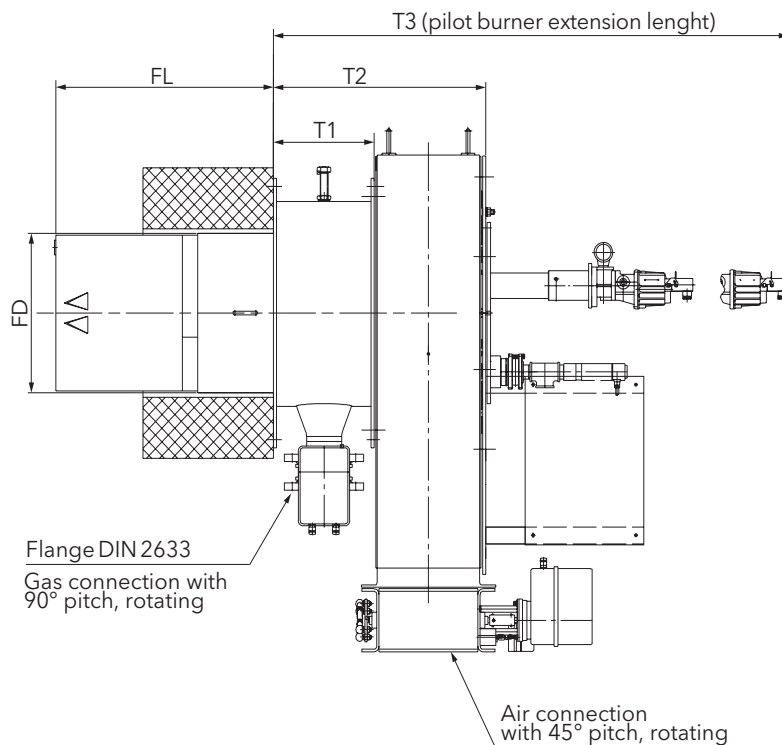
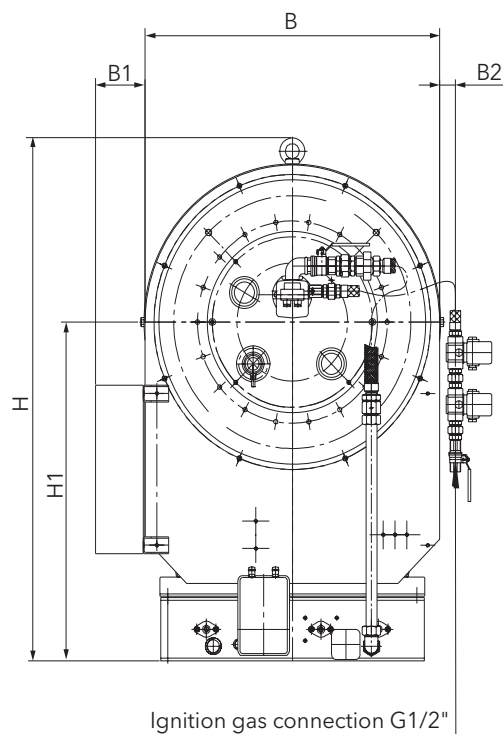

Air connection flange

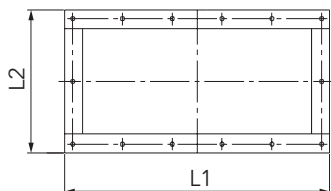

Details of boiler front plate

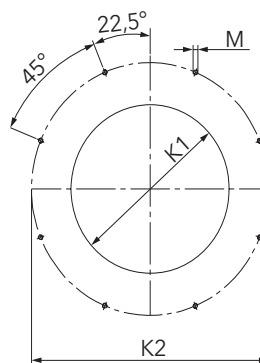

Model	Weight (kg)	Gas connection	H	H1	B	B1	B2*	T1	T2	T3*	FL*	FD*	L1	L2	K1	K2	M
EK-DUO 2.550	320 ... 400	DN80	1241	804	750	125	40	255	537	2005 ... 2150	320 ... 570	378	670	340	400	600	M12
EK-DUO 2.700	320 ... 400	DN80	1241	804	750	125	40	255	537	2005 ... 2150	320 ... 570	378	670	340	400	600	M12
EK-DUO 3.850	400 ... 470	DN80	1481	944	950	120	40	290	622	1810 ... 2390	350 ... 590	441 ... 456	827	386	480	690	M12
EK-DUO 3.1000	400 ... 470	DN80	1481	944	950	120	40	290	622	1810 ... 2390	350 ... 590	441 ... 456	827	386	480	690	M12
EK-DUO 4.1300	400 ... 420	DN100	1491	929	1000	122	40	420	802	2600 ... 2770	350 ... 620	506	840	440	525	725	M20
EK-DUO 4.1600	400 ... 420	DN100	1491	929	1000	122	40	420	802	2600 ... 2770	350 ... 620	506	840	440	525	725	M20

*: value dependent on design variant

DUOBLOCK RANGE

RPD

500 ... 80000 kW

2 stage progressive/modulating mechanical or electronic

- **Fuels:** - natural gas, low calorific value 6,99...11,39 kWh/Nm³
- light oil, viscosity 6 mm²/s at 20°C, low calorific value 11,86 kWh/kg
- heavy oil, viscosity 20...350 mm²/s at 50°C, net calorific value 10,97 kWh/kg;
- other fuels on request;
- co-combustion of various fuels or to eliminate liquid waste on request
- **Modulating ratio:** 1/3 for light, 1/6 for gas and 1/8 for gas with frequency converter
- **Protection level:** IP 41 (IP 54 and IP 65 on request)

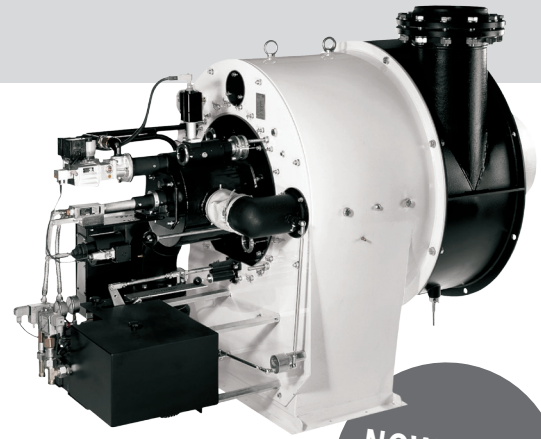

**NOW UP TO
80 MW**

RANGE OVERVIEW

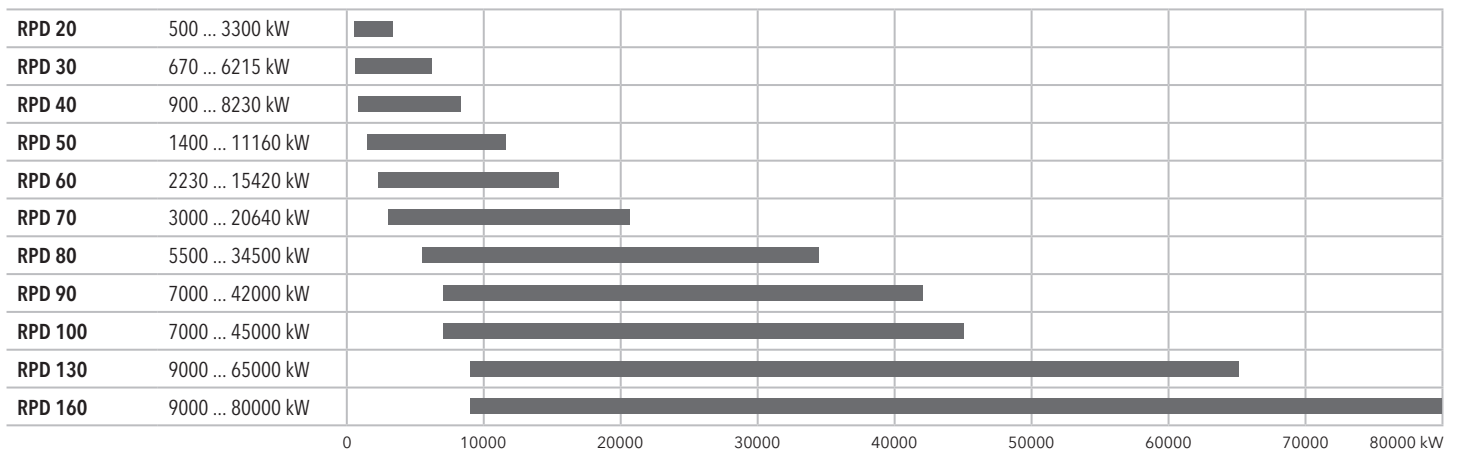

AVAILABLE CONFIGURATIONS

Model	Max output (kW) (air at 20°C)					Operation	
	Gas	Gas/Light oil	Light oil	Heavy oil	Gas/Heavy oil	Mechanical	Electronic
RPD 20	•	•	•	•	•	•	•
RPD 30	•	•	•	•	•	•	•
RPD 40	•	•	•	•	•	•	•
RPD 50	•	•	•	•	•	•	•
RPD 60	•	•	•	•	•	•	•
RPD 70	•	•	•	•	•	•	•
RPD 80	•	•	•	•	•	•	•
RPD 90	•	•	•	•	•	•	•
RPD 100	•	•	•	•	•	•	•
RPD 130	•	•	•	•	•	•	•
RPD 160	•	•	•	•	•	•	•



DIMENSIONS (mm)

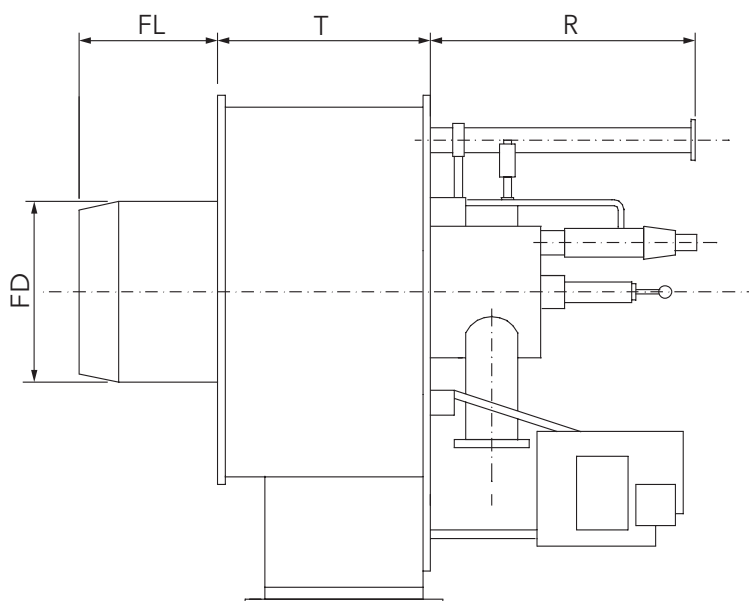
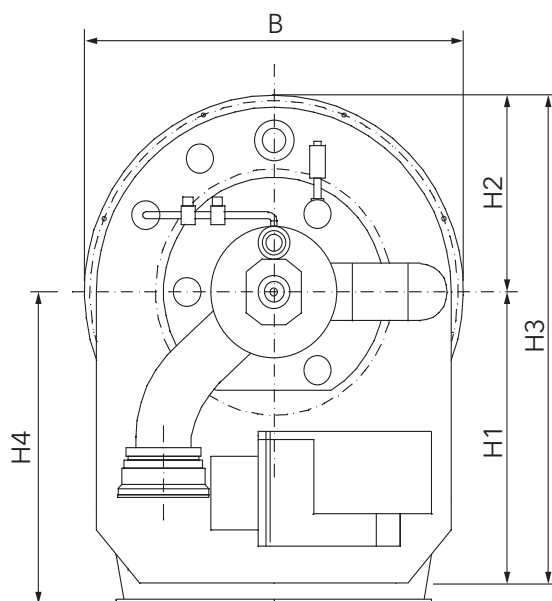

Air connection flange

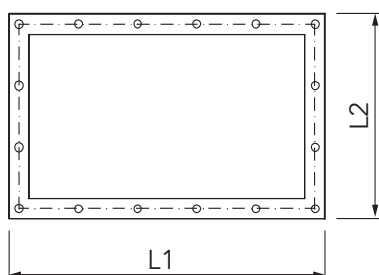

Details of boiler front plate

RPD 20 - 60

RPD 70 - 100

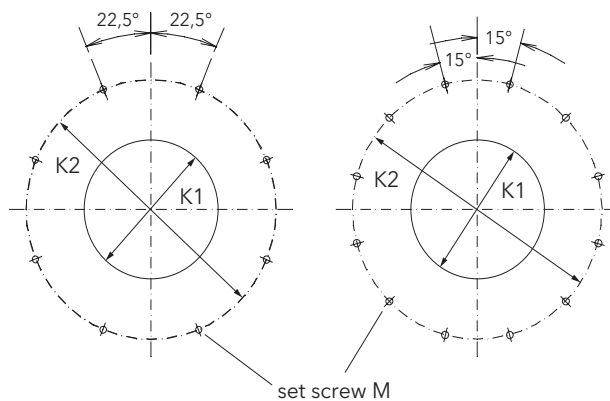

Model	Weight (kg)	Gas connection	H1	H2	H3	H4	B	T	R	FL	FD	L1	L2	K1	K2	M
RPD 20	300 ... 430	Rp2"	385	265	650	425	530	325	-	250	260	510	316	270	500	M10
RPD 30	300 ... 430	Rp3"	620	373	993	650	830	416	1265	317	371	670	410	385	790	M12
RPD 40	350 ... 450	Rp3"	620	373	993	650	830	416	1265	442	409	670	410	423	790	M12
RPD 50	450 ... 600	Rp5"	675	475	1150	740	1030	535	1743	370	456	830	506	470	990	M12
RPD 60	500 ... 640	Rp5"	700	497	1197	825	1080	622	1760	312	506	840	560	520	1040	M12
RPD 70	700 ... 900	Rp5"	780	580	1360	900	1240	731	2010	469	626	1026	690	640	1200	M12
RPD 80	900 ... 1200	Rp8"	820	675	1495	1000	1450	860	2320	600	710	1192	790	740	1400	M12
RPD 90	1100 ... 1400	Rp8"	905	850	1755	1100	1800	890	2720	810	870	1390	832	883	1750	M12
RPD 100	1150 ... 1450	Rp8"	905	850	1755	1100	1800	890	2720	810	920	1390	832	935	1750	M12
RPD 130	value dependent on design variant															
RPD 160	value dependent on design variant															

*: value dependent on design variant

GAS TRAINS

NEXTRON N6/N7 - Mechanical version (EN676 configuration)

DUNGS

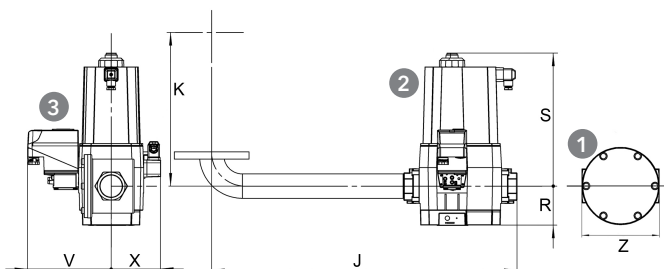

1. gas filter (integrated in Dungs threaded design)
2. compact gas train (safety valve + main valve)
3. leakage control device

DUNGS basic gas trains delivery scope and description:

- gas compact unit MBC
- leakage test device VPS 504 S 02
- minimum gas pressure switch
- connecting piece between burner and gas train

DUNGS gas trains		
Designation	Type	Code
GT-d552-1"1/2 (*)	Threaded design	3750504
GT-d553-2" (*)	Basic version	3750505
GT-d554-65	Flanged design Basic version	3750506
GT-d555-80		3750507
GT-d556-100		3750508

J	K		R	S	V	X
	N6	N7				
656	373	404	80	186	184	102
741	403	434	96	328	208	126
792	351	382	183	246	192	110
812	371	402	207	292	199	117
852	371	402	244	329	208	126

	Z
Rp 1"1/2	157
Rp 2"	155

*: model with integrated filter

SIEMENS

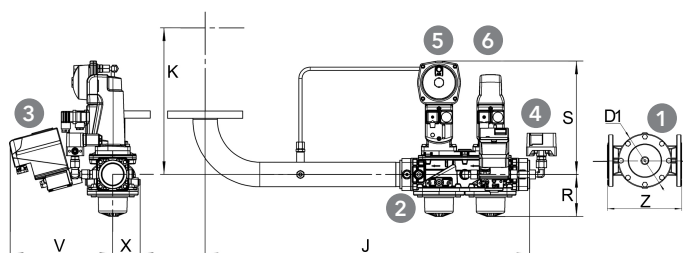

1. gas filter
2. gas main valve
3. leakage control device
4. minimum gas pressure switch
5. actuator SKP25
6. actuator SKP15

SIEMENS basic gas trains delivery scope and description:

- gas compact unit VGD20/40 including actuators SKP15 and SKP25
- leakage test device VPS504 S 02
- adapter set for leakage test device VPS504 (for threaded design)
- minimum gas pressure switch
- connecting piece between burner and gas train

SIEMENS gas trains		
Designation	Type	Code
GT-s551-1"1/2	Threaded design	3750519
GT-s552-2"	Basic version	3750520
GT-s553-65	Flanged design Basic version	3750521
GT-s554-80		3750522
GT-s555-100		3750523
GT-s556-125		3750524

J	K		R	S	V	X
	N6	N7				
800	373	404	139	282	255	65
800	403	361	139	282	255	65
792	351	382	123	303	208	108
812	371	402	135	313	215	110
852	371	402	145	331	226	126
902	371	402	175	349	240	140

	ØD1	Z
DN40	155	223
DN50	155	210
DN65	190	245
DN80	208	285
DN100	263	340
DN125	315	400

i Gas trains are fully mounted, electrical connected and tested (electrical, hydraulic, leakage)
Additional components (filter and other options) in order to comply to the local regulation and codes of practise must be ordered separately

FILTERS

FG-Rp1"1/2	Gas train in threaded design Basic version	3750543
FG-Rp2"		3750544
FG-DN65	Gas train in flanged design Basic version	3750545
FG-DN80		3750546
FG-DN100		3750547
FG-DN125		3750548

NEXTRON N6/N7 - Pneumatic version (EN676 configuration)

SIEMENS

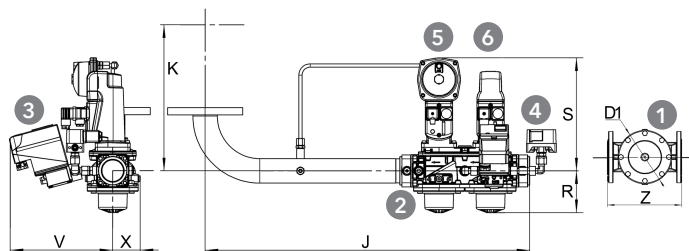

1. gas filter
2. gas main valve
3. leakage control device
4. minimum gas pressure switch
5. actuator SKP25
6. actuator SKP15

SIEMENS basic gas trains delivery scope and description:

- gas compact unit VGD20/40 including actuators SKP15 and SKP25
- leakage test device VPS504 S 02
- adapter set for leakage test device VPS504 (for threaded design)
- minimum gas pressure switch
- connecting piece between burner and gas train

SIEMENS gas trains		
Designation	Type	Code
GT-s351-1"1/2	Threaded design	3750531
GT-s352-2"	Basic version	3750532
GT-s353-65	Flanged design	3750533
GT-s354-80		3750534
GT-s355-100		3750535
GT-s356-125		3750536

J	K		R	S	V	X	ØD1	Z	
	N6	N7							
800	373	404	139	282	255	65	DN40	155	223
800	403	361	139	282	255	65	DN50	155	210
792	351	382	123	303	208	108	DN65	190	245
812	371	402	135	313	215	110	DN80	208	285
852	371	402	145	331	226	126	DN100	263	340
902	371	402	175	349	240	140	DN125	315	400

i Gas trains are fully mounted, electrical connected and tested (electrical, hydraulic, leakage)
 Additional components (filter and other options) in order to comply to the local regulation and codes of practise must be ordered separately

FILTERS

FG-Rp1"1/2	Gas train in threaded design Basic version	3750543
FG-Rp2"		3750544
FG-DN65	Gas train in flanged design Basic version	3750545
FG-DN80		3750546
FG-DN100		3750547
FG-DN125		3750548

GAS TRAINS

EK EVO 6/7 and NEXTRON N6/N7 - Electronic version (EN676 configuration)

DUNGS

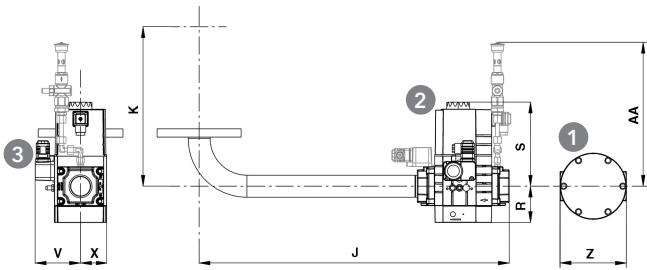

1. gas filter (integrated in Dungs threaded design)
2. compact gas train (safety valve + main valve)
3. minimum gas pressure switch

DUNGS basic gas trains delivery scope and description:

- gas compact unit MBC
- minimum gas pressure switch
- connecting piece between burner and gas train

DUNGS gas trains		
Designation	Type	Code
GT-d452-1"1/2 (*)	Threaded design	3750510
GT-d453-2" (*)	Basic version	3750511
GT-d454-65	Flanged design Basic version	3750512
GT-d455-80		3750513
GT-d456-100		3750514

Dimensions	J	K		R	S	V	X	AA	Z
		EK6/N6	EK7/N7					PED	
d1"1/2-Rp1"1/2	685	375	405	80	190	100	60	320	157
d2"-Rp2"	760	405	435	100	330	125	115	385	155
d65-DN65	795	355	385	185	250	110	100	385	245
d80-DN80	815	375	405	210	295	155	110	275	285
d100-DN100	875	375	405	250	330	165	115	275	340

*: model with integrated filter

SIEMENS

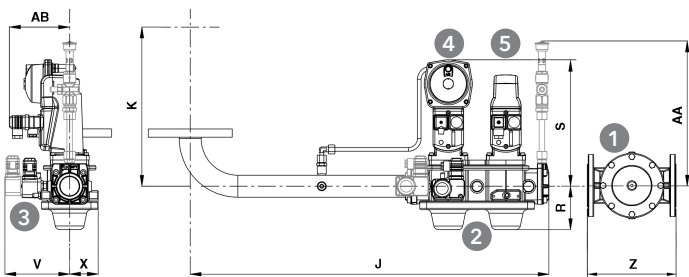

1. gas filter
2. gas main valve
3. minimum gas pressure switch
4. actuator SKP25
5. actuator SKP15

SIEMENS basic gas trains delivery scope and description:

- gas compact unit VGD20/40 including actuators SKP15 and SKP25
- minimum gas pressure switch
- connecting piece between burner and gas train

SIEMENS gas trains		
Designation	Type	Code
GT-s451-1"1/2	Threaded design	3750525
GT-s452-2"	Basic version	3750526
GT-s453-65	Flanged design Basic version	3750527
GT-s454-80		3750528
GT-s455-100		3750529
GT-s456-125		3750530

Dimensions	J	K		R	S	V		X	AA	AB	Z
		EK6/N6	EK7/N7			PED	PED				
s1"1/2-DN65	795	375	405	100	285	105	145	65	320	135	245
s2"-DN80	805	405	365	105	285	105	145	100	325	135	285
s65-DN80	795	355	385	120	305	125	125	110	365	140	285
s80-dN80	815	375	405	135	315	125	125	110	375	135	285
s100-DN100	855	375	405	145	335	145	145	125	385	135	340
s125-DN125	905	375	405	180	350	160	160	140	400	135	400

i Gas trains are fully mounted, electrical connected and tested (electrical, hydraulic, leakage)
Additional components (filter and other options) in order to comply to the local regulation and codes of practise must be ordered separately

FILTERS

FG-Rp1"1/2	Gas train in threaded design Basic version	3750543
FG-Rp2"		3750544
FG-DN65	Gas train in flanged design Basic version	3750545
FG-DN80		3750546
FG-DN100		3750547
FG-DN125		3750548

EK EVO 8/9 and NEXTRON N8/N9 - Electronic version (EN676 configuration)

DUNGS

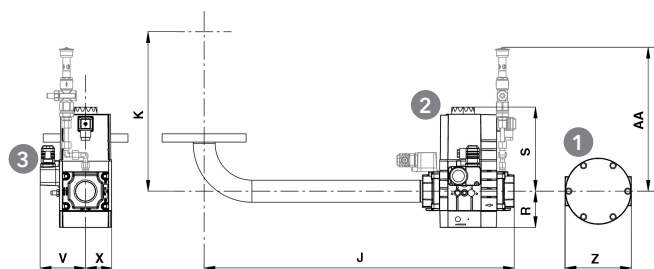

1. gas filter (integrated in Dungs threaded design)
2. compact gas train (safety valve + main valve)
3. minimum gas pressure switch

DUNGS basic gas trains delivery scope and description:

- gas compact unit MBC
- minimum gas pressure switch
- connecting piece between burner and gas train

DUNGS gas trains		
Designation	Type	Code
GT-d457-2" (*)	Threaded design	3750515
GT-d458-65	Flanged design Basic version	3750516
GT-d459-80		3750517
GT-d460-100		3750518

Dimensions	J	K		R	S	V	X	AA	Z
		EK8/N8	EK9/N9					PED	
d2"-Rp2"	760	598	623	100	330	125	115	385	155
d65-DN65	795	598	623	185	250	110	100	385	245
d80-DN80	815	598	623	210	295	155	110	275	285
d100-DN100	875	598	623	250	330	165	115	275	340

*: model with integrated filter

SIEMENS

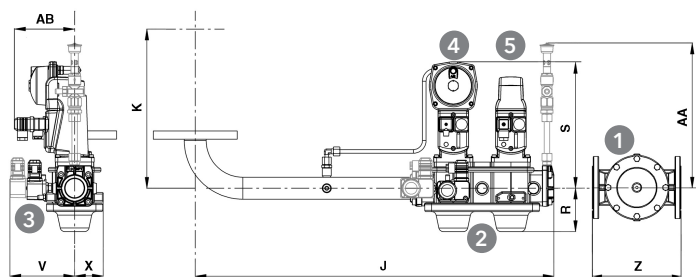

1. gas filter
2. gas main valve
3. minimum gas pressure switch
4. actuator SKP25
5. actuator SKP15

SIEMENS basic gas trains delivery scope and description:

- gas compact unit VGD20/40 including actuators SKP15 and SKP25
- minimum gas pressure switch
- connecting piece between burner and gas train

SIEMENS gas trains		
Designation	Type	Code
GT-s457-2"	Threaded design	3750537
GT-s458-65	Flanged design Basic version	3750538
GT-s459-80		3750539
GT-s460-100		3750540
GT-s461-125		3750541

Dimensions	J	K		R	S	V		X	AA	AB	Z
		EK8/N8	EK9/N9			PED	PED				
s2"-DN80	805	598	623	105	285	105	145	100	325	135	285
s65-DN80	795	598	623	120	305	125	125	110	365	140	285
s80-DN80	815	598	623	135	315	125	125	110	375	135	285
s100-DN100	855	598	623	145	335	145	145	125	385	135	340
s125-DN125	905	598	623	180	350	160	160	140	400	135	400

i Gas trains are fully mounted, electrical connected and tested (electrical, hydraulic, leakage)
 Additional components (filter and other options) in order to comply to the local regulation and codes of practise must be ordered separately

FILTERS

FG-Rp2"	Gas train in threaded design - Basic version	3750544
FG-DN65	Gas train in flanged design Basic version	3750545
FG-DN80		3750546
FG-DN100		3750547
FG-DN125		3750548

DUNGS

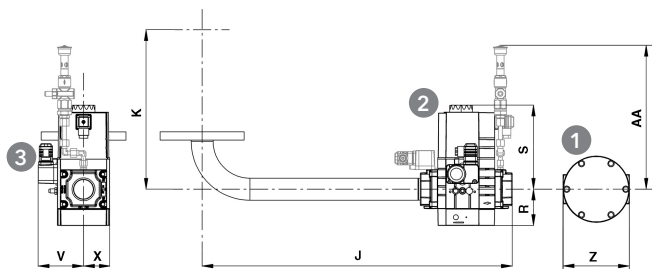

1. gas filter
2. compact gas train (safety valve + main valve)
3. minimum gas pressure switch

DUNGS basic gas trains delivery scope and description:

- gas compact unit MBC
- minimum gas pressure switch
- connecting piece between burner and gas train

i Other configurations:
available on request

DUNGS gas trains		
Designation	Type	Code
d80	Flanged design Basic version	on request
d100		on request
d125		on request

SIEMENS

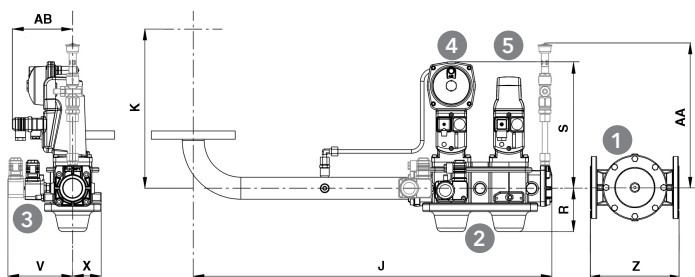

1. gas filter
2. gas main valve
3. minimum gas pressure switch
4. actuator SKP25
5. actuator SKP15

SIEMENS basic gas trains delivery scope and description:

- gas compact unit VGD20/40 including actuators SKP15 and SKP25
- minimum gas pressure switch
- connecting piece between burner and gas train

i Other configurations:
available on request

SIEMENS gas trains		
Designation	Type	Code
s80	Flanged design Basic version	on request
s100		on request
s125		on request
s150		on request

i Gas trains are fully mounted, electrical connected and tested (electrical, hydraulic, leakage)
Additional components (filter and other options) in order to comply to the local regulation and codes of practise must be ordered separately

FILTERS

FG-DN80	Gas train in flanged design Basic version	3750546
FG-DN100		3750547
FG-DN125		3750548
FG-DN150		on request

GHO-TRON - Mechanical version (EN676 configuration)

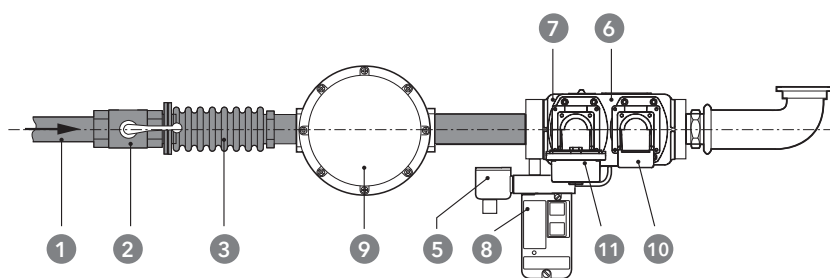

- 1. main gas pipe
- 2. ball valve*
- 3. anti-vibration coupling*
- 5. minimum gas pressure switch
- 6. safety gas valve
- 7. main gas valve
- 8. leakage control device*
- 9. gas filter* (governor included in the valve)
- 10. actuator SKP 15
- 11. actuator SKP 75

*: additional components to be ordered separately, e.g.: maximum gas pressure switch and other gas options in order to comply to the local regulation and codes of practise

Designation	Description	Code
GT-2"	VGD20.503	on request
GT-DN65	VGD40.065	on request
GT-DN80	VGD40.080	on request
GT-DN100	VGD40.100	on request
GT-DN125	VGD40.125	on request

GHO-TRON configuration:
gas ignition unit is included in the body of the burner, the price is included in the burner price.

i Gas trains are fully mounted, electrical connected and tested (electrical, hydraulic, leakage)
Additional components (filter and other options) in order to comply to the local regulation and codes of practise must be ordered separately

FILTERS

2"	on request
DN65 - 2"1/2	on request
DN80 - 3"	on request
DN100 - 4"	on request
DN125 - 5"	on request

GAS TRAIN CONNECTION PIPE

GTCP RP50 platform 2-3-4	GHO-TRON 2-3-4 with GT-2"	on request
GTCP reducer from DN80 to DN65 platform 2-3-4	GHO-TRON 2-3-4 with GT-DN65	on request
GTCP reducer from DN100 to DN80 platform 4-5	GHO-TRON 4-5 with GT-DN100	on request
GTCP reducer from DN125 to DN80 platform 5	GHO-TRON 5 with GT-DN125	on request

CONTROL UNIT

BT300 System: control box for electronic burners

This device is composed of control box for safety and for programming the parameters of the burner.

Main functions: control of mono- and dual fuel burners with intermittent or continuous operation through a step by step servo motor up to 10 Nm. Equippable with the following modules: fan speed regulation, burner power regulation, the control of combustion air excess, CO level through simple or combined probe and the communication via Bus system.

Specific functions for each type of control box:

- BT320 for single fuel burner and intermittent operation, with an output 0...10 V, 0/4...20 mA and the management of two servomotors;
- BT330 for single fuel burner and continuous operation, using suitable flame detectors, with an output 0...10 V, 0/4...20 mA and the management of three servomotors;
- BT340 for dual fuel burner and continuous operation, using suitable flame detectors, with an output 0...10 V, 0/4...20 mA and the management of three servomotors.

Main characteristics of the control box:

- power supply: 230 V -15...+10%, 50 Hz;
- servomotors from 1,2 to 10 Nm.

COMMUNICATION MODULE

BT300 module for electronic burners mounted in the switch cabinet of the burner (Note: one LCM module is required)	ModBus/BT3	3754081
	ProfiBus/BT3	3750142
	Ethernet/BT3	in progress

LCM MODULE

Module mounted in factory, required for O ₂ control, Variatron and communication buses connections (Note: only one LCM module is necessary for these 3 options; for GL-E burners it is already included)	3751118
------------------------------------------------------------------------------------------------------------------------------------------------------------------------------------------------------------------------	---------

REMOTE SOFTWARE

Kit to connect a PC laptop to the BT300 for its parametrization	LSA100 + USB/CAN + CD-Rom	3751130
-----------------------------------------------------------------	---------------------------	---------

O₂/CO REGULATION for BT300 (and Etamatic)

Device for adjustment of the combustion air excess in order to compensate any variations in the calorific value of the fuel, in the temperature and in the pressure of the combustion air. The regulator is installed in a dedicated electrical panel separate from the burner near the probe that measures the level of oxygen in the fumes. The calibration of the probe does not require a reference gas, the correction curve is defined in the dedicated equipment for acquisition and processing of signals and then sent to the control unit via the external module LCM.

The correction of the air excess value is carried out on the position of the air damper and the fan speed controller ensuring a high and constant thermal efficiency during the whole heating season. The value of air excess is immediately displayed on the screen as a percentage.

Kit for O ₂ and CO control (Note: LCM module is required)	Kit O ₂ LT2/LS2 / 300 mm	3751129
	Kit O ₂ /CO LT2/KS1 / 300 mm	3751128

CONTROL UNIT

<p>Electronic control Etamatic with 4 DPS-adjusting outputs for servodrives up to 50 mA of direct current with:</p> <ul style="list-style-type: none"> • incorporated tightness control of the valves; • incorporated regulator of power; • incorporated counter of working hours with pulse transducer; • incorporated relay of flame; • incorporated program of O₂ regulation, including the system Lamtec with connecting bus. <p>For the regulation of O₂ it is required additionally:</p> <ul style="list-style-type: none"> • device for O₂ regulation, code 3751701. 	Code on request, depending on configuration
<p>Electronic control Etamatic S with a steady adjusting output for the regulation of the number of revolutions of the fan supplying the air of burning and 4 DPS-adjusting outputs for the servodrives up to 50 mA of direct current with:</p> <ul style="list-style-type: none"> • incorporated tightness control of the valves; • incorporated regulator of power; • incorporated counter of working hours with pulse transducer; • incorporated relay of flame; • incorporated program of O₂ regulation, including the system Lamtec with connecting bus. <p>For the regulation of O₂ it is required additionally:</p> <ul style="list-style-type: none"> • device for O₂ regulation, code 3751701. <p>For the control of the number of revolutions it is required additionally:</p> <ul style="list-style-type: none"> • Static frequency converter; • Switch Namur. 	Code on request, depending on configuration

O₂ REGULATION (only for Etamatic)

<p>Regulation of O₂ (only combined with the electronic control Etamatic) with:</p> <ul style="list-style-type: none"> • Lambda-probe LS 2; • gas consumption counter MEV, length 300 mm; • probe installation fittings SEA; • Lambda-transmitter LT 2 in the wall-type casing IP 54, including 1 analog output 0/4-20 mA = 0-10% O₂, without display 	3751701
<p>Option:</p> <ul style="list-style-type: none"> • measurement of the flue gas temperature and calculation of the coefficient of burning efficiency, including 2 temperature sensors PT100 and 2 analog outputs, freely adjustable on the flue gas temp. and the burner's load 	Code on request, depending on configuration

ETAMATIC OEM ACCESSORIES

Etamatic commissioning and regulation software: on request depending from language interface	3753366
Customer interface Etamatic OEM	3751683
Operation and display Etamatic OEM	1718850339
Assembly frame for operation and display unit (assembly into switch cabinet)	14028667
Pro-Bus DP interface and processor	3752995

Note: either customer interface or operation and display unit has to be included

BALL VALVE

	Female threaded ball valve, max. working gas pressure 1 bar	FRp1/2"-1 bar	3751028
		FRp3/4"-1 bar	3751029
		FRp1"-1 bar	3751030
		FRp1"1/2-1 bar	3751031
		FRp2"-1 bar	3751032
	Flanged ball valve, max. working gas pressure 16 bar	DN40-16 bar	3751033
		DN50-16 bar	3751034
		DN65-16 bar	3751035
		DN80-16 bar	3751036
		DN100-16 bar	3751037
		DN125-16 bar	3751038
		DN150-16 bar	3751039

ANTI-VIBRATION COUPLING (COMPENSATOR)

	Male-threaded anti-vibration coupling	MRp1"	3751018
		MRp1"1/2	3751019
		MRp2"	3751020
	Flanged anti-vibration coupling, max. working gas pressure 10 bar	DN40-10 bar	3751021
		DN50-10 bar	3751022
		DN65-10 bar	3751023
		DN80-10 bar	3751024
		DN100-10 bar	3751025
		DN125-10 bar	3751026
		DN150-10 bar	3751027

GAS FILTER

	Non-ferrous filter, max. pressure 1 bar	3/4" x 92 mm	3333261049
		1" x 135 mm	3333261050
	Non-ferrous filter with flange PN16, max. pressure 1 bar	DN40 x 223 mm	3750545
		DN50 x 210 mm	3750546
		DN65 x 245 mm	14013839
		DN80 x 285 mm	14013850
		DN100 x 340 mm	3750547
		DN125 x 400 mm	3750548
		DN150 x 450 mm	14013905
	Non-ferrous filter with flange PN16, max. pressure 4 bar	DN40 x 223 mm	14013916
		DN50 x 210 mm	14013927
		DN65 x 245 mm	14013938
		DN80 x 285 mm	14013949
		DN100 x 340 mm	14013960
		DN125 x 400 mm	14013971
DN150 x 450 mm		14013982	

PRESSURE REGULATOR

<p>Gas pressure regulator GDJ Max. working pressure 0,4 bar, non-ferrous metal</p> 	GDJ 1/2" x 100 mm	12,5 ... 25 mbar	3333123399
		spring for 16 ... 28 mbar	1478682753
		spring for 22 ... 40 mbar	1478781122
		spring for 40 ... 55 mbar	12001218
	GDJ 3/4" x 125 mm	12,5 ... 25 mbar	3333123400
		spring for 22,5 ... 35 mbar	1478682775
		spring for 25 ... 75 mbar	1478682786
	GDJ 1" x 125 mm	12,5 ... 25 mbar	3333123401
		spring for 22,5 ... 35 mbar	1478682775
		spring for 25 ... 75 mbar	1478682786
	GDJ h3/8"-Rp1/2" x 155 mm	12,5 ... 25 mbar	3333123402
		spring for 22,5 ... 35 mbar	1478682800
	spring for 25 ... 75 mbar	1478682811	
GDJ d2"-Rp2" x 200 mm	12,5 ... 25 mbar	3333123403	
	spring for 22,5 ... 35 mbar	1478682833	
	spring for 25 ... 75 mbar	1478682844	
<p>Gas pressure regulator FRS Max. working pressure 0,4 bar, non-ferrous metal</p> 	FRS s40-DN40 x 200 mm	10 ... 30 mbar	1478490702
		red spring for 25 ... 55 mbar	1478435327
		yellow spring for 30 ... 70 mbar	1478435338
		black spring for 60 ... 110 mbar	1478435349
	FRS s50-DN50 x 230 mm	10 ... 30 mbar	1478490713
		red spring for 25 ... 55 mbar	1478435372
		yellow spring for 30 ... 70 mbar	1478435383
		black spring for 60 ... 110 mbar	1478435394
	FRS s65-DN65 x 290 mm	with spring 10 ... 30 mbar	1478490724
		red spring for 25 ... 55 mbar	1478435429
		yellow spring for 30 ... 70 mbar	1478435430
		black spring for 60 ... 110 mbar	1478435441
		pink spring for 100 ... 150 mbar	1478494328
	FRS s80-DN80 x 310 mm	with spring 10 ... 30 mbar	12001096
		red spring for 25 ... 55 mbar	1478435429
		yellow spring for 30 ... 70 mbar	1478435430
		black spring for 60 ... 110 mbar	1478435441
		pink spring for 100 ... 150 mbar	1478494328
	FRS s100-DN100 x 350 mm	with spring 10 ... 30 mbar	12001097
		red spring for 25 ... 55 mbar	1478435474
		yellow spring for 30 ... 70 mbar	1478435485
		black spring for 60 ... 110 mbar	1478435496
		pink spring for 100 ... 150 mbar	1478781519
	FRS s125-DN125 x 400 mm	with spring 10 ... 30 mbar	12001098
	red spring for 25 ... 55 mbar	1478434982	
	yellow spring for 30 ... 70 mbar	1478434993	
	black spring for 60 ... 110 mbar	1478435009	
	pink spring for 100 ... 150 mbar	1478740474	
FRS s150-DN150 x 480 mm	with spring 10 ... 30 mbar	12001099	
	red spring for 25 ... 55 mbar	1478435032	
	yellow spring for 30 ... 70 mbar	1478435043	
	black spring for 60 ... 110 mbar	1478435054	
	pink spring for 100 ... 150 mbar	1478781484	

PRESSURE REGULATOR

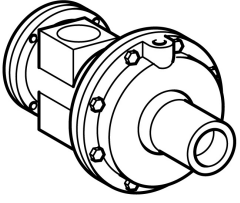
Gas pressure regulator RS 250	with safety valve and flange PN16, max. working pressure 6 bar	RS250 DN25 x 230 mm	code on request
		RS250 DN50 x 230 mm	code on request
		RS250 DN80 x 310 mm	code on request
		RS250 DN100 x 350 mm	code on request
		RS250 DN150 x 480 mm	code on request
Gas pressure regulator RS 251	with safety valve and flange PN16, max. working pressure 4 bar	RS251 DN50 x 310 mm	code on request
		RS251 DN80 x 410 mm	code on request
Safety blow-off valve S10 	with internal thread Rp1", max. working pressure 1 bar	discharge pressure 80 mbar	1478687054
		discharge pressure 100 mbar	1478687065
		discharge pressure 120 mbar	1478687076
		discharge pressure 140 mbar	1478687087
		discharge pressure 160 mbar	1478687098
		discharge pressure 180 mbar	1478687101
		discharge pressure 200 mbar	1478687112
		discharge pressure 220 mbar	1478687123
		discharge pressure 240 mbar	1478687134
		discharge pressure 260 mbar	1478687145
		discharge pressure 280 mbar	1478687156
		discharge pressure 300 mbar	1478687167

GAS PRESSURE SWITCH

	For installation on double electromagnetic valves, max. working pressure 0,5 bar	GW50A5	3751554
		GW150A5	3751555
		GW500A5	3751557
	For installation on electromagnetic/motorized valves, max. working pressure 0,5 bar	GW50A6	3751556
		GW150A6	3752190
		GW500A6	3752189

MANOMETER

	Gas manometers with push-button valve, Rp1/2"	0 - 60 mbar	3751627
		0 - 100 mbar	3751546
		0 - 160 mbar	3751550
		0 - 250 mbar	3751551
		0 - 600 mbar	3751552
		0 - 1,6 bar	3751545
		0 - 6 bar	3751544

TEST BURNER

Test burner with push-button valve, Rp1/2"	max pressure 0,5 bar	3751553
---------------------------------------------------	----------------------	----------------

SEALS AND CONNECTING KIT

	Screwing set: 1 seal, 4 bolts, 4 nuts, 4 washers	DN25	1478811767
		DN40	3751040
		DN50	3751041
		DN65	3751042
		DN80	3751043
		DN100	3751044
		DN125	3751045
		DN150	3751046

INSERT RING

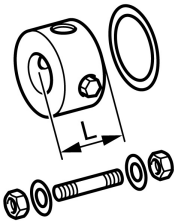
	Insert ring with connections Rp1/2" and Rp3/4" for manometer and test burner	DN40 x 50 mm	3752194
		DN50 x 50 mm	3752195
		DN65 x 50 mm	3752196
		DN80 x 50 mm	3752197
		DN100 x 50 mm	3752198
		DN125 x 50 mm	3752199
		DN150 x 50 mm	3752200

FLOW COUNTER

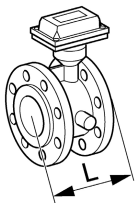
	TERZ 94 max pressure 10 bar	6 - 100 m ³ /h - DN50 x 150 mm	12001361
		10 - 250 m ³ /h - DN80 x 120 mm	12001362
		25 - 400 m ³ /h - DN80 x 120 mm	12001363
		25 - 400 m ³ /h - DN100 x 150 mm	12001364
		40 - 650 m ³ /h - DN100 x 150 mm	12001365
		85 - 1000 m ³ /h - DN150 x 175 mm	12001366
		100 - 1600 m ³ /h - DN150 x 175 mm	12001367

FLEXIBLE HOSE

	Stainless steel, max pressure 4 bar	Rp1/2" x 500 mm	4488681772
		Rp1/2" x 1000 mm	4488681783
		Rp3/4" x 500 mm	4488681794
		Rp3/4" x 1000 mm	4488682708
		Rp1" x 500 mm	4488682719
	Stainless steel, max pressure 1 bar	Rp1" x 1000 mm	4488682720
		Rp3/8"-Rp1/2" x 500 mm	4488696511
		Rp3/8"-Rp1/2" x 1000 mm	4488696522
		d2"-Rp2" x 500 mm	4488696533
		d2"-Rp2" x 1000 mm	4488696544

HOLDER

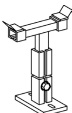
	<p>Holder for gas train</p>	<p>For gas train s40-DN40...s150-DN150</p>	<p>3752216</p>
-----------------------------------------------------------------------------------	-----------------------------	--------------------------------------------	----------------

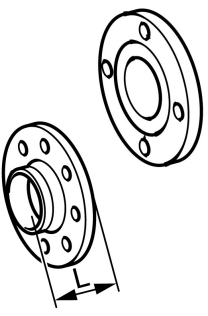

FLANGES

	<p>Threaded flange PN16</p>	<p>Rp3/4"</p>	<p>3333109195</p>
	<p>1"</p>	<p>3333109196</p>	
	<p>Rp1/2"</p>	<p>3333109197</p>	
	<p>Rp2"</p>	<p>3333109198</p>	
	<p>Welded flange PN16</p>	<p>DN40 x 42 mm</p>	<p>5318353048</p>
	<p>DN50 x 45 mm</p>	<p>5318428082</p>	
	<p>DN65 x 45 mm</p>	<p>5318428093</p>	
	<p>DN80 x 50 mm</p>	<p>5318428106</p>	
	<p>DN100 x 52 mm</p>	<p>5318428117</p>	
	<p>DN125 x 55 mm</p>	<p>5318428128</p>	
	<p>DN150 x 55 mm</p>	<p>5318428139</p>	

STRAIGHT PIPE

	<p>Flanged, PN16</p>	<p>DN40 x 500 mm</p>	<p>3752235</p>
	<p>DN50 x 250 mm</p>	<p>3752236</p>	
	<p>DN50 x 500 mm</p>	<p>3752237</p>	
	<p>DN65 x 250 mm</p>	<p>3752238</p>	
	<p>DN65 x 500 mm</p>	<p>3752239</p>	
	<p>DN80 x 250 mm</p>	<p>13019834</p>	
	<p>DN80 x 500 mm</p>	<p>1688421230</p>	
	<p>DN100 x 250 mm</p>	<p>3752240</p>	
	<p>DN100 x 500 mm</p>	<p>1688421252</p>	
	<p>DN125 x 250 mm</p>	<p>1688421525</p>	
	<p>DN125 x 500 mm</p>	<p>1688421274</p>	
	<p>DN150 x 250 mm</p>	<p>1688421536</p>	
	<p>DN150 x 500 mm</p>	<p>1688421296</p>	
	<p>Adapting, flanged PN16</p>	<p>DN25 - DN40 x 144 mm</p>	<p>1688541804</p>
	<p>DN25 - DN50 x 159 mm</p>	<p>1688586714</p>	
	<p>DN25 - DN65 x 173 mm</p>	<p>1688590469</p>	
	<p>DN25 - DN80 x 254 mm</p>	<p>1688653209</p>	
	<p>DN40 - DN50 x 163 mm</p>	<p>3752223</p>	
	<p>DN40 - DN65 x 177 mm</p>	<p>3752224</p>	
	<p>DN40 - DN80 x 182 mm</p>	<p>3752226</p>	
	<p>DN50 - DN65 x 180 mm</p>	<p>3752225</p>	
	<p>DN50 - DN80 x 185 mm</p>	<p>3752227</p>	
	<p>DN50 - DN100 x 197 mm</p>	<p>1688590458</p>	
	<p>DN65 - DN80 x 197 mm</p>	<p>1688421401</p>	
	<p>DN65 - DN100 x 197 mm</p>	<p>1688421412</p>	
	<p>DN80 - DN100 x 202 mm</p>	<p>1688421423</p>	
	<p>DN80 - DN125 x 232 mm</p>	<p>1688421434</p>	
	<p>DN80 - DN150 x 245 mm</p>	<p>1688602591</p>	
<p>DN100 - DN125 x 234 mm</p>	<p>1688421445</p>		
<p>DN100 - DN150 x 247 mm</p>	<p>1688421456</p>		
<p>DN125 - DN150 x 250 mm</p>	<p>1688421467</p>		

ELBOW PIPE

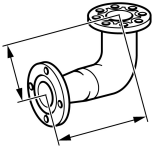
Angle 	90°, male/female	3/4"	3333109257
		1"	3333103790
		d1"-1/4-Rp2"	3333116894
		h3/8"-Rp1/2"	3333103791
	90°, female/female	d2"-Rp2"	3333103792
		1"	3333109311
		h3/8"-Rp1/2"	3333110711
		d2"-Rp2"	3333110712
Elbow 	PN16, connection Rp1/2"	DN40 x 99 mm	3752182
		DN50 x 121 mm	3752183
		DN65 x 140 mm	3752185
		DN80 x 164,5 mm	3752184
		DN100 x 204,5 mm	1688421354
		DN125 x 245,5 mm	1688421365
		DN125 x 283,5 mm	1688421376
Connection piece 	90°, flanged PN16	DN65 - DN40 x 235 mm	1688551557
		DN65 - DN50 x 235 mm	1688551568
		DN80 - DN40 x 246,5 mm	1688421092
		DN80 - DN50 x 249,5 mm	1688421105
		DN80 - DN65 x 249,5 mm	1688421116
		DN80 - DN80 x 264,5 mm	1688421127
		DN80 - DN100 x 266,5 mm	1688590481
		DN100 - DN80 x 293 mm	1688551615
		DN150 - DN65 x 503,5 mm	1688666166
		DN150 - DN80 x 418,5 mm	1688421138
		DN150 - DN100 x 420,5 mm	1688421149
		DN150 - DN125 x 423,5 mm	1688421150
		DN150 - DN150 x 423,5 mm	1688421161

GAS PIPE

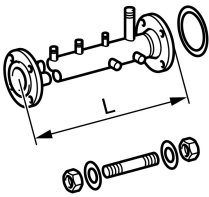
Connections	h3/8"-Rp1/2"x300 mm with 2 connections 1/2" and 1 connection 1/4" for DMV SE 512		3333212374
	d2"-Rp2"x300 mm with 2 connections 1/2" and 1 connection 1/4" for DMV SE 520		3333212375
	Connections for test burner, pressure switch, pressure valve, pressure release valve, ignition valve, safety valve	DN40 x 900 mm	14030405
		DN50 x 900 mm	14030449
		DN65 x 950 mm	code on request
		DN80 x 1100 mm	14030504
		DN100 x 1300 mm	14030537
		DN125 x 1550 mm	code on request
		DN150 x 1800 mm	14030570

VALVES GROUP, TYPE LBA...A

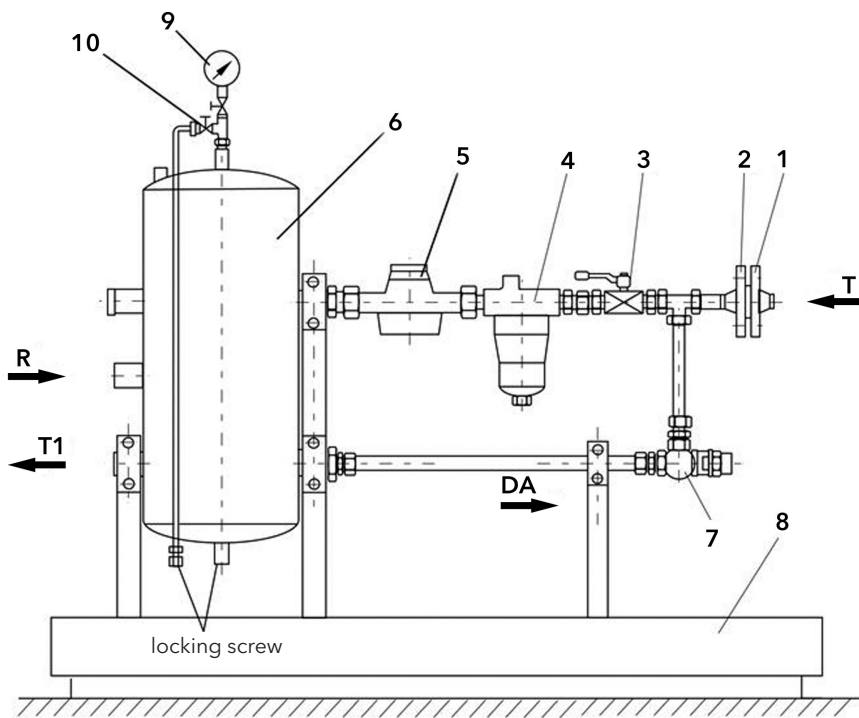

Base equipment

1. Welded flange PN16
2. Connecting flange PN16
3. Ball valve PN16
4. Fuel filter
5. Fuel rate counter with roller counter
6. Pressure tank
7. Relief valve
8. Fuel collector with holding
9. Glycerol manometer 0...10 bar
10. Air valve

		LBA 600 A	LBA 1200 A	LBA 2400 A	LBA 3000 A
Burner pump capacity	l/h	600	1200	2400	3000
Fuel rate for burner capacity "T"	l/h	10 ... 200	10 ... 400	30 ... 1000	75 ... 2000
Flange connection "T" on feed line	PN16	DN15	DN15	DN20	DN25
Burner connection "R" and "T1" (feed + return pipe)		Rp1/2"	Rp3/4"	Rp1"	Rp1"
Delivery pressure (depending on air venting way)	manual	min 1 bar / max 2,5 bar			
	automatic	1 bar			
Volume pressure tank	dm ³	6	12	22	22
Dimension L x B	mm	1050 x 360	1300 x 400	1300 x 400	1300 x 400
Code		on request	on request	on request	on request

Notes:

- oil supply pressure (pressure range) is created by separate force pump in ring pipeline or by lift of tank to greater height;
- for oil feed line of monoblock burners, operating with oil EL and L (heavy oil M and S on request);
- suits for equipment in accordance with DIN 4755/2, TRD 411, TRD 604.

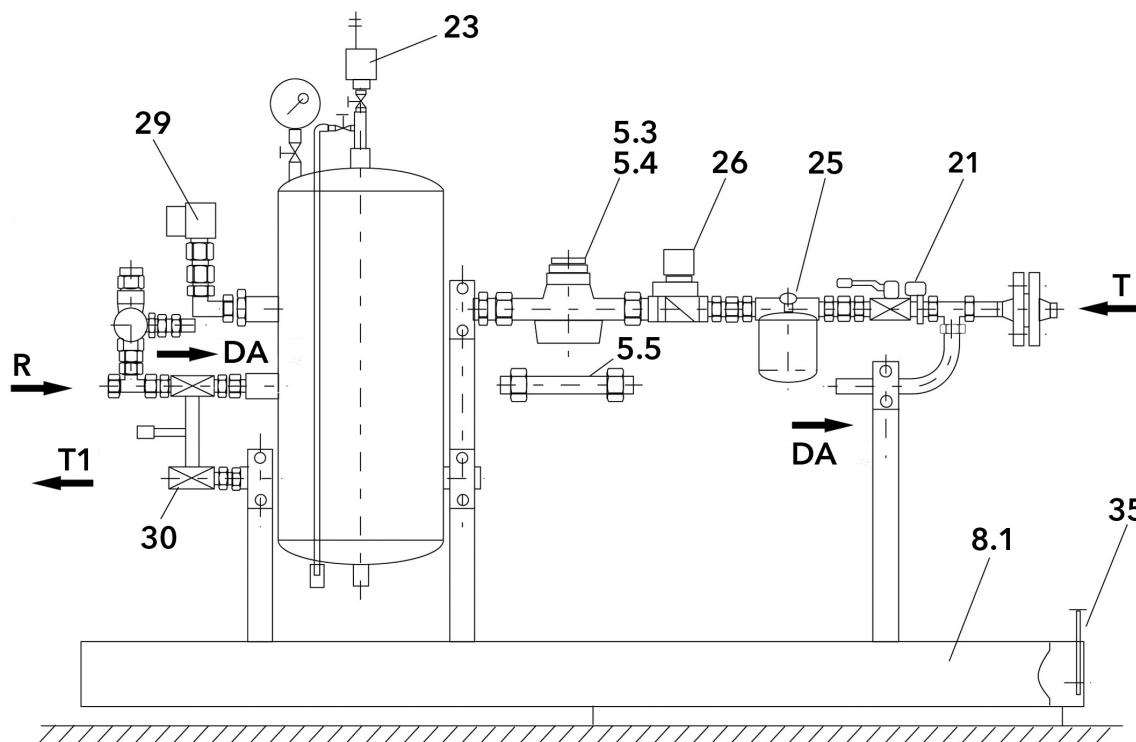

Ref.	Description	LBA 600 A	LBA 1200 A	LBA 2400 A	LBA 3000 A
5.3	Fuel rate counter with pulse transducer (Reed)	0,1 l / Imp	0,1 l / Imp	1 l / Imp	1 l / Imp
5.4	Fuel rate counter with inductive pulse transducer	0,01 l / Imp	0,01 l / Imp	0,01 l / Imp	0,1 l / Imp
5.5	Fitting for fuel rate counter (during maintenance)	Rp3/4"	Rp3/4"	Rp1"	Rp1"1/4
8.1	Extended fuel collector for options M, DM, DK	This option needs when choice od options M and/or DK			
21	Limit switch for ball valve (position 1)	230 V / 50 Hz / IP65, mounted onto ball valve. Tested at installation.			
23	Automatic air valve	Rp3/8", PN16, 150°C	Rp3/8", PN16, 150°C	Rp3/8", PN16, 150°C	Rp3/8", PN16, 150°C
25	Fuel filter	Rp1/2"	Rp1/2"	Rp3/4"	Rp1"
26	Safety electromagnetic valve	Rp1/2"	Rp1/2"	Rp3/4"	Rp1"
29	Oil pressure switch	Rp1/2", 230 V / 50 Hz / IP54, setting range 0,2...2,5 bar			
30	Two ball valves combination	Rp1/2"	Rp3/4"	Rp1"	Rp1"
35	Leakage control built in fuel collector	230 V / 50 Hz / IP65	230 V / 50 Hz / IP65	230 V / 50 Hz / IP65	230 V / 50 Hz / IP65

Codes on request.

OIL CONNECTION UNIT

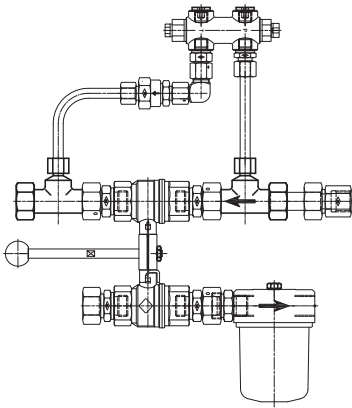

Unit consists of:
 - double ball valve (with or without limit switch);
 - oil filter
 - safety valve with relief valve, non return valve
 - pipes, threaded connections, seals

Unit with double ball valve with limit switch	Rp 1/2"	3755291
	Rp 3/4"	3754259
	Rp 1"	3755292
Unit with double ball valve without limit switch	Rp 1/2"	14037863
	Rp 3/4"	14037874
	Rp 1"	14037885

MANOMETER



Manometer/vacuometer glycerine-filled
 Connection Rp1/2" A radial

-1...+3 bar	1098748467
-1...+5 bar	1098748478
0...4 bar	1098748489
0...6 bar	3333116345
0...10 bar	1098748490
0...16 bar	1098585471
0...25 bar	3333261128
0...40 bar	1090160374
0...60 bar	1098114290
Kit manometer hydraulic block N6/N7	3755398

LEAKAGE CONTROL DEVICE



Signal device for oil for wall mounting HMW with 1 optoelectronic detector and 2 m cable, signal part in housing
 HxBxT=110x75x55
 230 V / 50-60 Hz / IP65
 250 V

1758812000

Possibility to connect
 2 optoelectronic detector:

with cable 2 m	1758812011
with cable 10 m	1758812022
with cable 30 m	1758812033

AIR VALVE

Automatic air valve with ball valve Rp3/8"	1478812577
--------------------------------------------	------------

RELIEF/PRESSURE MAINTAINING VALVE

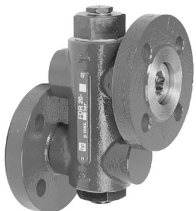
		Connection (DN)	Fuel rate (l/h)	Pressure degree (bar)	
	Threaded design, directly adjustable, with spring load for keeping adjusted working and max pressure, viscosity range 2,8...480 sSt	1/4"	6...120	0,5...1,5	1478812044
				1...4	1478730083
				2...9	1478731940
		3/8"	15...160	0,5...1,5	1478812055
				1...4	1478812066
				2...9	1478812077
		1/2"	30...600	0,5...1,5	1478812088
				1...4	1478720874
				2...9	1478812099
		3/4"	100...2000	0,5...3,5	1478812102
				2...9	1478812113
				0,5...1,5	1478812124
		1"	300...6000	1...4	1478812135
				2...9	1478812146
0,5...1,5	1478812157				
1"1/4	500...10000	1...4	12001314		
		2...9	1478812168		
		0,5...1,5	1478812179		
	Flanged design, directly adjustable, with spring load for keeping adjusted working and max pressure, viscosity range 2,8...480 sSt	DN15	30...600	0,5...1,5	1478812179
				1...4	1478729973
				2...9	1478812180
		DN20	100...2000	0,5...3,5	1478812191
				2...9	1478812204
		DN25	300...6000	0,5...1,5	1478812215
				1...4	1478785851
				2...9	1478812226
		DN32	500...10000	0,5...1,5	1478812237
				1...4	1478812248
				2...9	1478812259

WELDED FLANGE

	Welded flange PN 16 according to DIN 2633, form C from RSt 37-2 as external flange for oil mounting PN16	DN15	5318675203
		DN20	3333101876
		DN25	5318353059
		DN32	5318704652
		DN40 x 42 mm	5318353048
		DN50 x 45 mm	5318428082
	Welded flange PN40 according to DIN 2635, form C from C22 as external flange for oil mounting PN40	DN15	5318557486
		DN20	3333101916
		DN25	5318556494
		DN32	5318556507
		DN40 x 42 mm	5318556518
		DN50 x 45 mm	5318575308

SEALS AND CONNECTING KIT

Screwing set: 1 seal, pin screws, hexagon nuts, lining washer	DN15 PN16 / PN40	3752201
	DN20 PN16 / PN40	3752202
	DN25 PN16 / PN40	3752203

BALL VALVE

0...60°C for 64 bar, 0...120°C for 40 bar, 20...150°C for 30 bar	1/4"	1478736157
	1/2"	1478736168
	3/4"	1478736179
	1"	1478736180
-20...150°C for 16 bar	DN25	1478732910
	DN32	1478732921
	DN40	1478732932
	DN50	1478732943
	DN65	1478732954
	DN80	1478732965
-20...120°C for 40 bar, -20...150°C for 30 bar	DN15	1478734938
	DN20	1478734949
	DN25	1478734950
	DN32	1478734961
	DN40	1478734972
	DN50	1478734983

LIGHT OIL FILTER

Self-cleaning filter	Rp3/4"	12006508
100 ... 500 l/h	Rp3/8" male (burner side) / female - 70 µm - one pipe	3333110172
100 ... 500 l/h	Rp3/8" male (burner side) / female - 75 µm - one pipe	3333115482
200 ... 700 l/h	Rp1/2" male (burner side) / female - 75 µm - one pipe	3333115483
100 ... 500 l/h	Rp3/8" male (burner side) / female - 70 µm - two pipes	3333110175
100 ... 500 l/h	Rp3/8" male (burner side) / female - 75 µm - two pipes	3333110176
200 ... 700 l/h	Rp1/2" male (burner side) / female - 75 µm - two pipes	3333110174

OIL FILTER FD FOR SUCTION AND PRESSURE OPERATION

 Oil pressure max. 2 bar	Rp 1/2" - 700 l/h	3754100
	Rp 3/4" - 1700 l/h	3754101
	Rp 1" - 2000 l/h	3754102

LIGHT OIL FLOW COUNTER

Without pulse transducer	10 ... 400 l/h - 16 bar - Rp1/2"	1368746803
	10 ... 400 l/h - 16 bar - DN15	1368746892
	30 ... 1000 l/h - 16 bar - Rp3/4"	1368746836
	30 ... 1000 l/h - 16 bar - DN20	1368746927
	75 ... 2000 l/h - 16 bar - Rp1"	1368746869
	75 ... 2000 l/h - 16 bar - DN25	1368746950
With pulse transducer RV 0,1 (Reed)	10 ... 400 l/h - 16 bar - Rp1/2"	1368746814
	10 ... 400 l/h - 16 bar - DN15	1368746905
	30 ... 1000 l/h - 16 bar - Rp3/4"	1368746847
	30 ... 1000 l/h - 16 bar - DN20	1368746938
	75 ... 2000 l/h - 16 bar - Rp1"	1368746870
	75 ... 2000 l/h - 16 bar - DN25	1368746961
With pulse transducer IN 0,01 (Inductive)	10 ... 400 l/h - 16 bar - Rp1/2"	1368746825
	10 ... 400 l/h - 16 bar - DN15	1368746916
	30 ... 1000 l/h - 16 bar - Rp3/4"	1368746858
	30 ... 1000 l/h - 16 bar - DN20	1368746949
	75 ... 2000 l/h - 16 bar - Rp1"	1368746881
	75 ... 2000 l/h - 16 bar - DN25	1368746972
Threaded connection	VSR - Rp1/2"	3753933
	VSR - Rp3/4"	3754536
	VSR - Rp1"	3755097

FREQUENCY CONVERTER ABB FOR EXTERNAL INSTALLATION

IP21 with: <ul style="list-style-type: none"> • EMC filter • Inductor • Control panel 	3 kW / 6,9 A	3755418
	4 kW / 8,8 A	3755419
	5,5 kW / 12 A	3755420
	7,5 kW / 15,4 A	3755421
	11 kW / 23 A	3753996
	15 kW / 31 A	3753997
	18,5 kW / 38 A	3753998
	22 kW / 45 A	3753999
	30 kW / 59 A	3755422
	37 kW / 72 A	3754484
	45 kW / 87 A	3755423
IP55 with: <ul style="list-style-type: none"> • EMC filter • Inductor • Control panel 	3 kW / 6,9 A	3753013
	4 kW / 8,8 A	3753014
	5,5 kW / 12 A	3753015
	7,5 kW / 15,4 A	3753016
	11 kW / 23 A	3754361
	15 kW / 31 A	3754362
	18,5 kW / 38 A	3754363
	22 kW / 45 A	3754364
	30 kW / 59 A	3754037
	37 kW / 72 A	3752317
	45 kW / 87 A	3754365



SUBSIDIARIES:

GERMANY

Dreichstrasse, 10
64546 Mörfelden
Walldorf
Tel. +49 06 105 968 192
Fax +49 06 105 968 199

NETHERLANDS

Meerpaalweg, 1
1332 BB Almere
P.O. box 30048
1303 AA Almere
Tel. +31 088 69 573 11
Fax +31 088 69 573 90

SWITZERLAND

Elcotherm AG
Sarganserstrasse 100
7324 Vilters
Tel. +41 (0)81 725 25 25
Fax +41 (0)81 723 13 59
www.elco.ch

AUSTRIA

ELCO Austria GmbH
Aredstraße 16 - 18
2544 Leobersdorf
Tel. +43 (0)2256 639 99 32
Fax +43 (0)2256 644 11
www.elco.at

ENGLAND

Suite 3, The Crown House
Blackpole East,
Blackpole Road,
Worcester WR3 8SG
Tel. +44 01905 788010
Fax +44 01905 788011

FRANCE

14, rue du Saule Trapu
Parc d'activité du Moulin
91882 Massy
Tel. +33 01 60 13 64 64
Fax +33 01 60 13 64 65

ITALY

Viale Roma, 41
28100 Novara
Tel. +39 0732 633 590
Fax +39 0732 633 599

RUSSIA

Eniseyskaya str. 1, bld 1,
Office Center "LIRA" #415
129344 Moscow
Tel. +7 495 213 0300 #5700
Fax +7 495 213 0302

CHINA

17A2, V-Capital Bldg
No. 333 Xian Xia Road
200336 Shanghai
Tel. +86 21 6039 8691
Fax +86 21 6039 8620

Contact us to know more
about our products and solutions

www.elco-burners.com
contact@elco-burners.com